



TELEX COMMUNICATIONS, INC.
9600 ALDRICH AVE SO MINNEAPOLIS, MN 55420 U.S.A

81814

INSTRUCTION MANUAL

ORDER NO. 500

CB Antenna
The Penetrator

PN 801366

General Description

The Penetrator is a full-size $\frac{1}{2}$ -wave, omnidirectional antenna. A full-sized radiator with a lower radiation angle concentrates power closer to the ground. The antenna accepts AM, SSB and DSB signals. It can be fed by any standard 52 ohm coaxial cable such as RG-8/U and RG-58/U. For runs over 50 feet, RG-8/U or RG-213/U is recommended.

The Penetrator fits any mast material up to 1 $\frac{1}{2}$ " O.D. A 1 $\frac{1}{2}$ " plumbers pipe is highly recommended for mast due to its low cost and high strength.

"Warning: Installation of this product near powerlines is dangerous. For your safety, follow the installation directions."

Specifications

Gain	5.3 dB	Height	22'6" (6.85 m)
SWR (at resonance)	less than 1.2:1	Radial length	8'9" (2.66 m)
Nominal input impedance	50 ohms	Wind (survival)	80 mph (129 kmph)
Lightning protection	DC ground	Accepts mast	1 $\frac{1}{4}$ " to 1 $\frac{3}{4}$ " (3.17 cm to 4.12 cm)

Installation Instructions

Unpack the antenna and check the parts against the parts list.

Select the base assembly (Item 12), the two radial plates (Item 1), the M1 assembly (Item 13), and the upper insulator (Item 11).

Refer to Figure 1 and loosely assemble these parts as shown, using the $\frac{1}{4}$ " x 1" screws and associated hardware. Do not tighten at this time.

NOTE: Make certain the end of the M1 assembly (Item 13) with the two holes is down and aligned with the holes in the insulator (see Figure 2). Remember to point the two smaller holes (located 5 $\frac{3}{8}$ " and 13" from the bottom end) away from the base bracket. These will be used to attach the matching rod assembly (see Figure 3).

Fasten the M1 assembly to the insulator with the #10 x 1 $\frac{1}{4}$ " screw, see Figure 2, Item 26 and associated hardware, Items 35 and 41. Tighten SECURELY.

Referring to Figure 2, assemble the $\frac{3}{8}$ " x 55" R1 tubes (Item 4) into brackets, align the holes and fasten with $\frac{1}{4}$ " x 1 $\frac{1}{4}$ " screws, nuts and lockwashers (Items 24, 34 & 40). Do not tighten nuts.

Tighten the $\frac{1}{4}$ " x 1" screws holding the base brackets and radial plates.

Remove the two rod support insulators (Item 21) and the two #10 x $\frac{3}{8}$ " Type T screws (Item 29) from the parts pack and attach them to the M1 assembly as shown in Figure 3.

Attach the matching rod and beta rod exactly as shown in Figure 3.

Tighten all hardware in the base assembly.

Refer to Figure 6 and assemble the radiator tubes M2, M3, M4, the top radial assembly and the radial elements. Refer to the compression clamps detail for their proper assembly.

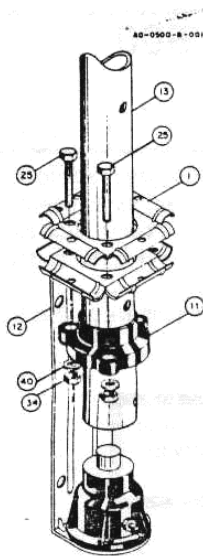

Figure 1

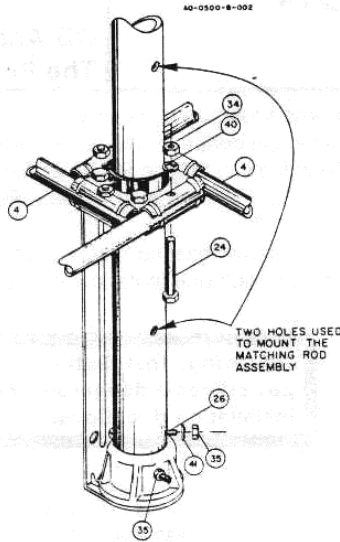

Figure 2

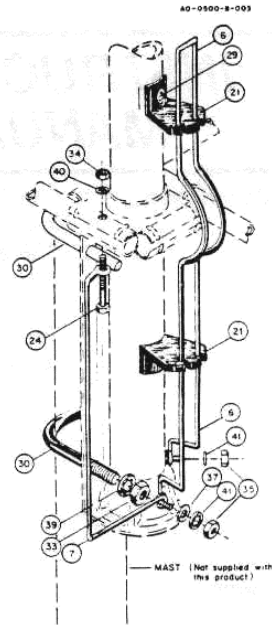

Figure 3

NOTE: The slot in the compression clamp should be aligned with the slot in the tubing (see Figure 5).

Make sure all the compression clamps are tightened securely.

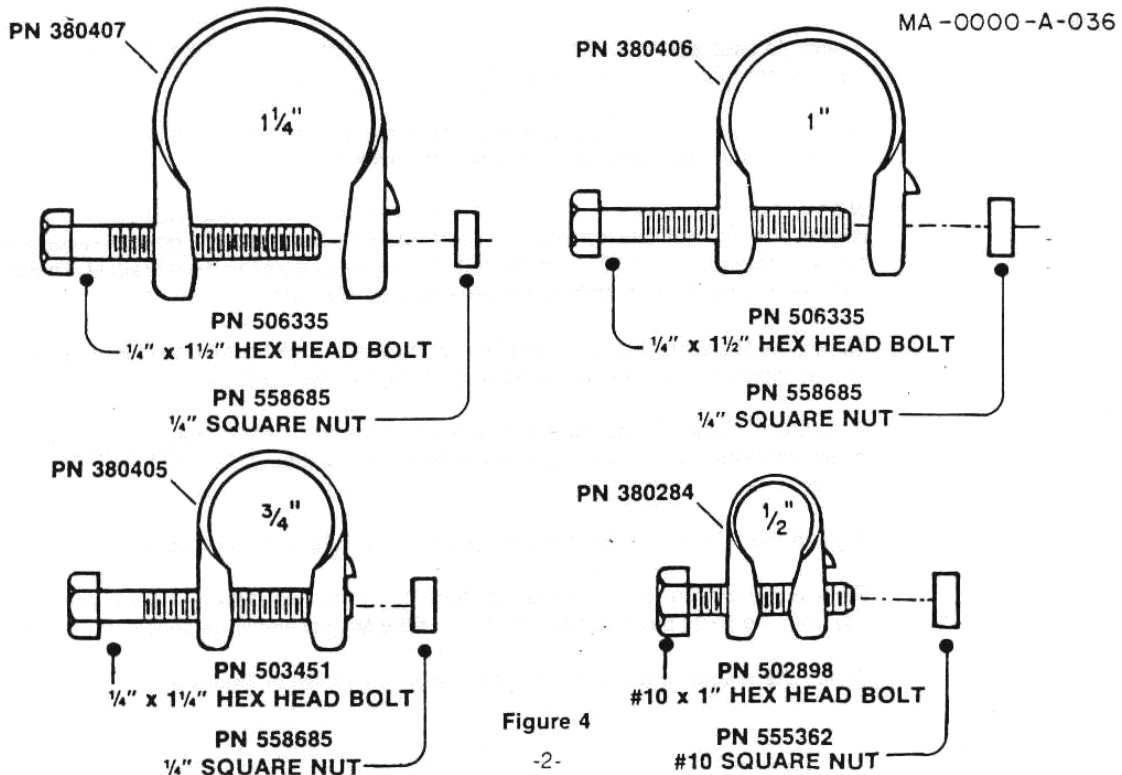

Figure 4

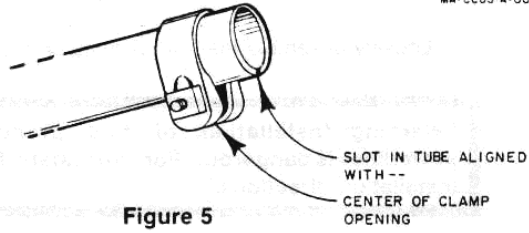

Figure 5

When assembling the tubes in either the radiator or the radials, slip the smaller tube inside the larger tube to the lengths shown in Figure 6. This is necessary for proper operation of the antenna.

() Assemble the top hat radials as shown in Figure 7. They should be spaced 90 degrees apart.

() Attach the four 1/8" caplugs on the end of the top hat radials and the 7/16" caplugs on the end of the R2 tubes.

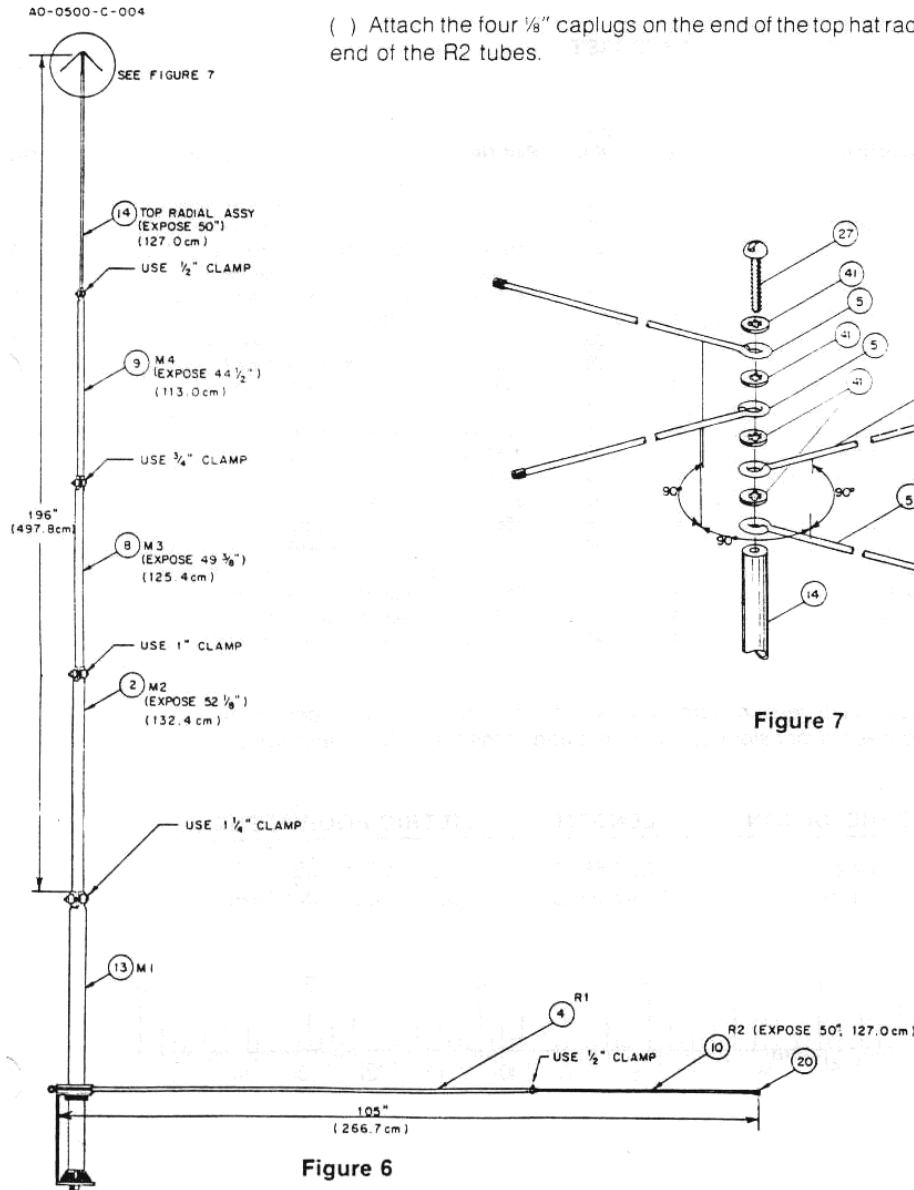

Figure 6

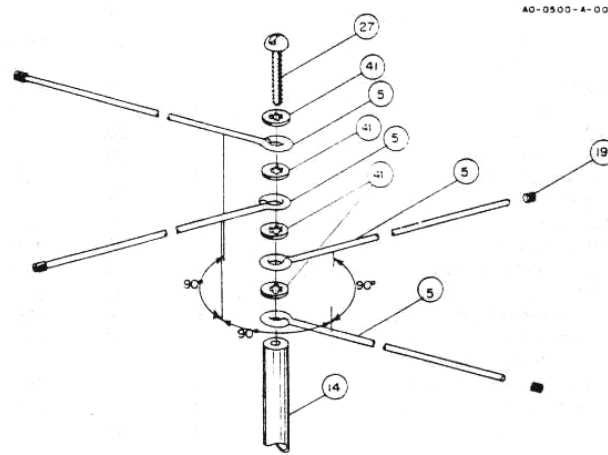

Figure 7

- () Check all hardware and tighten securely.
- () Loosely assemble the $5/16$ " U-bolts on the bracket as shown in Figure 3.

"Warning: Installation of this product near powerlines is dangerous. For your safety, follow the installation directions."

- () Mount the antenna on your mast and tighten the U-bolts securely.
- () Attach your coax to the connector, located on the bottom of the base bracket and hook to your transceiver.
- () This completes your installation.

PARTS LIST

Item No.	Part No.	Description	Qty	Item No.	Part No.	Description	Qty
1	160042	radial bracket	2			Parts Pack - continued	
2	170770	M2, 1 1/8" x 55"	1	22		(not assigned)	
3		(not assigned)		23		(not assigned)	
4	170400	R1, 3/8" x 55"	4	24	503451	screw, 1/4" x 1 1/4", hex head	5
5	170773	top hat radials	4	25	506389	screw, 1/4" x 1", hex head	3
6	170774	matching rod	1	26	506440	screw, #10 x 1 3/4", round head	1
7	170775	beta rod	1	27	502898	screw, #10 x 1", hex head	6
8	170300	M3, 3/4" x 52"	1	28	506335	screw, 1/4" x 1 1/2" hex head	2
9	170295	M4, 3/4" x 47"	1	29	526530	screw, #10 x 3/8" type T	2
10	175165	R2, 7/16" O.D. x 52"	4	30	543792	U-bolt, 7/16" x 1 3/8" x 2 1/4"	2
11	463056	upper insulator	1	31		(not assigned)	
12	879757	base assembly	1	32	555362	nut, #10 square	5
13	878804	M1, assembly, 1 1/4" x 71" tube	1	33	556945	nut, 7/16" hex jam	4
14	875810	top radiator assembly	1	34	556960	nut, 3/8" hex	8
	871507	Parts Pack	1	35	556970	nut, #10 hex	7
15	380284	compression clamp, 1/8"	5	36	558685	nut, 1/4", square	3
16	380405	compression clamp, 3/8"	1	37	567130	flatwasher, #10 ZMI	1
17	380407	compression clamp, 1 1/4"	1	38		(not applicable)	
18	380406	compression clamp, 1"	1	39	567075	lockwasher, 7/16" internal	5
19	455624	1/8" caplug	4	40	567110	lockwasher, 1/4" internal	8
20	455644	7/16" caplug	4	41	567125	lockwasher, #10 internal	8
21	463642	rod support	2				

The following scale and conversion factors are listed for your convenience in determining the relationship between dimensions given in feet and inches and the metric system:

UNIT	ABBREVIATION	LENGTH	METRIC EQUIVALENT
INCH	IN or "	0.083 FEET	2.540 CENTIMETERS
FOOT	FT or '	12 INCHES	30.480 CENTIMETERS

