

Cat. No. 21-1574  
**OWNER'S MANUAL**

Please read before using this equipment.

# TRC-446

**Deluxe 4 Watt 40-Channel  
Mobile CB Radio  
with Weather Alert and ACE**

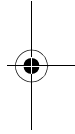
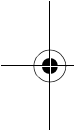

**RadioShack®**

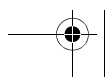
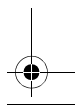
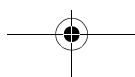
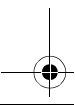

## FEATURES

---

Your RadioShack TRC-446 Deluxe 40-Channel Mobile CB Radio with Weather Alert is a high performance CB that also lets you tune to local and national weather service broadcasts. This CB is perfect for recreational, business, or emergency use. You can call other people who have CBs at home, in their vehicles, or at camp sites. You can also connect optional equipment to your CB, such as an external speaker which creates a PA system; or a DC power supply and base station antenna to use it as a base station in your home.

Your CB has these features:

**ACE (Audio Clarity Enhancer)** — suppresses noise levels while leaving the signal intact during reception. During transmitting, it enhances the signal, providing you with a significant reduction in reception and transmission noise.

**NOAA 7-Channel WX Band Receiver** — lets you tune to seven national weather service frequencies which provide local weather conditions and forecasts.

**WX/Alert Indicator** — shows the CB is ready to receive and indicates the reception of a weather alert

**Built-In SWR Meter** — helps you tune your antenna system to optimize your CB's performance.

**RF Gain Control** — lets you adjust reception to match the strength of the received signal.

**Convenient On-Microphone Channel Up/Down Controls** — let you quickly scan the band for communications.

**CH-9/NOR/CH-19 Switch** — lets you quickly tune to emergency Channel 9 or Channel 19 without using the rotary tuning control.

**Screw-On Microphone Connector** — ensures rugged operation and long life.

**PLL (Phase-Locked Loop) Frequency Synthesizer** — uses a precise frequency reference crystal to provide reliable and exact tuning.

**Two Ceramic Filters** — provide superior channel selectivity and prevent adjacent-channel interference.

**Specialized Squelch Circuit** — compensates for fading signals and eliminates signal chopping during reception.

**Last-Channel Memory** — tunes to the last selected channel each time you turn on the radio.

**Lighted SWR/RF/Signal Meter** — displays the signal strength and the standing wave ratio (SWR).

**Digital Channel Display** — makes the selected channel easy to see.

© 1999 Tandy Corporation.  
All Rights Reserved.

RadioShack is a registered trademark used by Tandy Corporation.

**Noise Blanking** — reduces the noise occasionally generated by nearby electrical motors or automotive ignition systems.

**CB/WX/PA Switch** — lets you quickly select among normal CB operation, weather mode, or public address mode.

**RX/TX Indicator** — shows whether the CB is transmitting or receiving.

**S/RF/SWR/CAL Switch** — lets you quickly change the display of the RF/Signal Meter to show radio input/output signal strength, the standing wave ratio of the antenna, or SWR calibration data.

**Universal Mounting Bracket** — lets you mount your CB securely in your vehicle.

**Note:** To use this CB, you need a mobile or base station antenna (not supplied). Your local RadioShack store has a wide variety of antennas. For more information, see "Installing an Antenna" on Page 7.

We recommend you record your CB's serial number here. The number is on the CB's back panel.

Serial Number \_\_\_\_\_

## FCC INFORMATION

The Federal Communications Commission (FCC) does not require you to have a license to operate this CB. However, the FCC does require that you read and know Part 95 of *FCC Rules*. These rules apply to the operation of a Class D CB. We have provided a copy of these regulations with your CB.

**Warning:** Do not open your CB to make any internal adjustments. Any internal adjustments can be made only by an authorized service technician.

Unauthorized internal adjustments and/or modifications can lead to illegal operation as defined by Part 95 of FCC Rules. Such illegal operation can lead to very serious consequences. To be safe and sure:

- Never open your CB's case.
- Never modify your CB.

Your CB might cause TV or radio interference even when it is operating properly. To determine whether your CB is causing the interference, turn off your CB. If the interference goes away, your CB is causing it. Try to eliminate the interference by either moving your CB away from the receiver or contacting your local RadioShack store for help. If you cannot eliminate the interference, the FCC requires that you stop using your CB.



# CONTENTS

---

---

<b>Installation .....</b>	<b>5</b>
Mounting the TRC-446 .....	5
Connecting the Microphone .....	6
Installing an Antenna .....	7
Selecting an Antenna .....	7
Connecting an Antenna .....	7
Using Vehicle Battery Power .....	7
Using the CB as a Base Station .....	8
Connecting Optional External Speakers .....	8
External CB Speaker .....	8
Public Address Speaker .....	9
Adjusting the Standing Wave Ratio .....	9
Standing Wave Ratio Guidelines .....	10
Standing Wave Ratio Performance .....	10
<b>A Quick Look at the Controls .....</b>	<b>11</b>
<b>Operation .....</b>	<b>12</b>
Changing Channels Using the Controls on the Microphone .....	13
Listening to Weather Broadcasts .....	13
Weather Alert .....	14
Using the Public Address Function .....	14
<b>CB Operation Tips .....</b>	<b>15</b>
Business Uses .....	15
Personal Uses .....	15
CB Courtesy .....	15
<b>Using Common 10-Codes .....</b>	<b>16</b>
Maximum Range .....	17
<b>Troubleshooting .....</b>	<b>18</b>
<b>Care and Maintenance .....</b>	<b>19</b>
<b>Specifications .....</b>	<b>21</b>

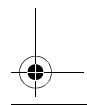
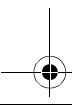
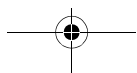
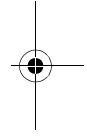
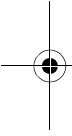

## INSTALLATION

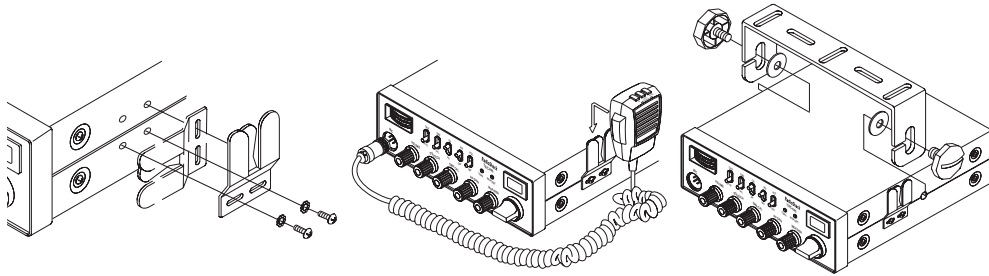

### MOUNTING THE MICROPHONE HOLDER

Using a Philips screwdriver and the supplied screw and washers, attach the supplied microphone holder to the CB's left or right side, either horizontally or vertically (depending on how you plan to use it).

### MOUNTING THE TRC-446

The most common mounting location for this CB is under a vehicle's dashboard. If you use the TRC-446 as a base station, you can place it on a desk, shelf, or table (See "Using the CB as a Base Station" on Page 8).

When mounting the CB in a vehicle, choose a location where:

- you can easily reach the CB
- wires and cables are routed away from the vehicle's pedals or other moving parts
- all wires and cables can reach their connection points

- the CB is not directly in front of heating vents

#### Cautions:

- If you use the TRC-446 in a vehicle, mount it securely to avoid damage to the CB or vehicle or injury to anyone in the vehicle during sudden starts or stops.
- Do not mount the CB where it could damage or interfere with the proper operation of any passive restraint safety device (an air bag or seat belt).

Follow these steps to mount the CB using the supplied hardware.

1. Select a location that provides secure mounting.

**Caution:** Be careful not to drill into anything behind the mounting surface.

2. Using the slots in the mounting bracket as a template, mark the positions for the screw holes.
3. In each marked location, drill a hole slightly smaller than the supplied mounting screws.

- Using a Phillips screwdriver, attach the mounting bracket to the mounting surface with the supplied large mounting screw and star lock washers.
- Attach the CB to the mounting bracket using the supplied rubber washers and mounting knobs.

## CONNECTING THE MICROPHONE

- Align the slot on the top of the microphone plug with the ridge

inside the **MIC** jack, then fully insert the plug into the jack.

- Secure the plug by turning the plug's locking nut clockwise.
- Slide the microphone onto the microphone holder.

To disconnect the microphone, unscrew the locking nut and gently pull out the microphone plug.

**Caution:** Always grasp the connector body when you are disconnecting the microphone. Never pull on the microphone cable.

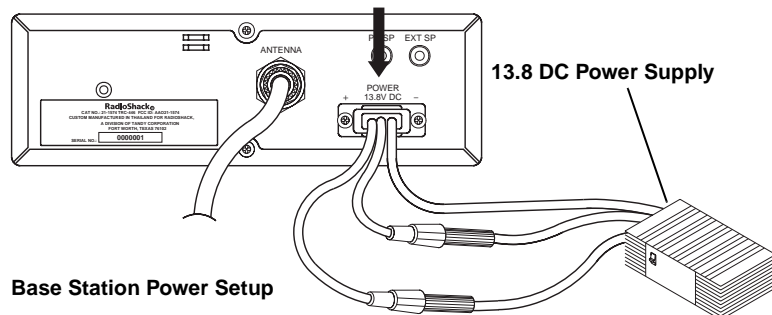
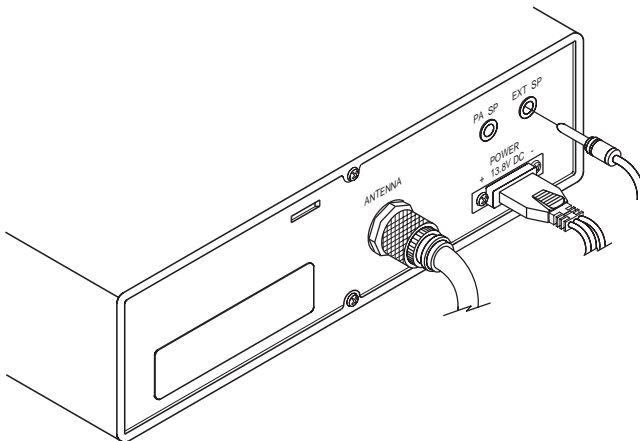

Base Station Power Setup

## INSTALLING AN ANTENNA

**Caution:** To prevent damage to your CB, do not attempt to transmit without an antenna attached.

### Selecting an Antenna

When you decide on an antenna and its location, consider these points:

- The antenna should be positioned as high as possible.
- The antenna and the antenna cable should be routed as far as possible from any source of electrical noise such as ignition systems, electric gauges, and motors.

Your local RadioShack store sells a variety of CB antennas for both mobile and base-station use. Choose the one that best meets your needs.

### Connecting an Antenna

Follow the mounting instructions supplied with the antenna you choose. Route the antenna cable to the CB, then thread the PL-259 antenna cable plug into **ANTENNA** on the back of the CB.

#### Cautions:

- Do not run the cable over sharp edges or moving parts that might damage it.
- Do not run the cable next to power cables or other CB antenna cables.

- Do not run the cable through a vehicle's engine compartment or other areas that produce extreme heat.

## USING VEHICLE BATTERY POWER

You can power this CB from your vehicle's battery or from standard AC power with an optional DC power supply. For information on using AC power, see "Using the CB as a Base Station" on Page 8.

Follow these steps to power the CB from your vehicle's battery.

1. Plug the single-connector end of the power cord into **POWER 13.8V DC** on the CB's back panel.
2. Connect the black wire to your vehicle's negative (-) battery terminal or to a metal part of the vehicle's frame that is not insulated from the frame by a plastic part.
3. Connect the red wire, with its in-line fuse, to a source of voltage that turns on and off with the ignition switch, such as a spare accessory terminal in your vehicle's fuse box. This assures you that power to the CB is turned off when you turn off the ignition.
4. Connect the orange wire, with its in-line fuse, to a source of voltage that supplies constant positive (+) power (regardless of the ignition switches position) or directly to your vehicle's positive (+) battery terminal. This enables the radio to "remember" the last channel you tuned to when you turn the radio back on.

## USING THE CB AS A BASE STATION

Although this CB is designed for mobile use, you can also use it as a base station. For base-station installation, you need a regulated 12-volt DC power supply, such as Cat. No. 22-504 available at your local RadioShack store.

**Caution:** Most 12-volt DC power supplies plug into a standard AC outlet to produce DC power. Before connecting your CB to a 12-volt DC power supply, read and follow the instructions included with the power supply.

You also need a base station antenna and coaxial antenna cable and connectors. Your local RadioShack store also carries a wide selection of suitable antennas, cables, and connectors.

Follow these steps to install the CB as a base station.

1. Mount the base station antenna as described in its owner's manual.

**Warning:** Use extreme caution when you install or remove a base station CB antenna. If the antenna starts to fall, let it go! It could contact overhead power lines. If the antenna touches the power line, contact with the antenna, mast, cable, or guy wires can cause electrocution and death. Call the power company to remove the antenna. DO NOT attempt to do so yourself.

2. Route the antenna cable to the CB, then connect the cable to **ANTENNA** on the back of the CB.

3. Plug the single connector end of the power cord into **POWER 13.8V DC** on the CB's back panel.
4. Connect the black wire to the DC power supply's negative (–) terminal.
5. Connect the red wire and orange wires, with in-line fuses, to the DC power supply's positive (+) terminal.

**Note:** Due to the lack of a constant 12VDC, as in an automotive installation, if you turn off the DC power supply, the CB “remembers” the last channel you tuned for only a few minutes. When you turn on the CB and the DC power supply again, the radio automatically tunes to Channel 9.

## CONNECTING OPTIONAL EXTERNAL SPEAKERS

You can connect an external CB or PA speaker to your CB. The larger, external speaker provides greater clarity. A PA speaker lets you take advantage of the amplifier and mic to use the CB as a public-address system.

### External CB Speaker

To connect an external CB speaker, use a speaker rated at 8-ohms and capable of handling 3–10 watts of power (such as Cat. No. 21-549). Simply plug the speaker cable's 1/8-inch plug into **EXT SP**. Connecting the external speaker automatically disconnects the internal speaker.



## Public Address Speaker

To connect a PA speaker to the CB, use an 8-ohm speaker capable of handling 5 or more watts of power and equipped with an 1/8-inch connector on the cable. Contact your local RadioShack store for a selection of suitable speakers. Plug into **PA SP**. See "Using the Public Address Function" on Page 14 for operation instructions.

## ADJUSTING THE STANDING WAVE RATIO

Most antennas are factory adjusted. However, you can usually improve performance by matching the characteristics of your antenna system to the CB's RF output power using the built-in SWR meter. The impedance of a CB's output compared to the impedance of the antenna and the antenna cable is typically slightly mismatched. By adjusting this impedance ratio to be as close to 1:1 as possible, you maximize the efficiency of your system.

After you have properly installed the antenna and routed its cable, follow these steps to adjust the standing wave ratio

**Note:** The SWR on some mobile and base-station antennas cannot be changed.

1. Turn on the CB by turning **OFF/VOLUME** clockwise until it clicks.
2. Set **S/RF/SWR/CAL** to **CAL**.
3. Hold down the microphone's talk button and adjust **SWR CAL** so the SWR/RF signal meter's needle

points to **CAL**▼ on the upper SWR scale.

4. Release the microphone's talk button.
5. Set **S/RF/SWR/CAL** to **SWR**.
6. Press the microphone's talk button again and note the actual SWR measurement on the upper SWR scale. See the chart on Page 10 for help in interpreting the SWR meter readings.

The SWR value takes into account the actual frequency of the RF signal transmitted. Therefore, you will get a different SWR reading from one CB channel to another. Almost all the CB transmissions usually fall within an acceptable range. However, for optimum radio performance, we recommend that you fine tune the antenna's system based on the channel you use most. If you have no particular channel preference, set your antenna's SWR for maximum performance on Channel 19.

## STANDING WAVE RATIO GUIDELINES

The ideal standing wave ratio (SWR) is 1:1, or a meter reading of 1 on the SWR meter's top scale. This reading, however, can only be obtained under laboratory conditions. A SWR ratio of 1.5:1 to 2:1 is excellent for most mobile CB antenna applications. This chart helps you interpret the different readings you might see.

### Standing Wave Ratio Performance

Ratio	Rating	Evaluation
1:1 – 1.5:1	Superior	Perfect match between the antenna/cable and the RF output of the CB.
1.5:1 – 2:1	Excellent	The antenna/cable system is an outstanding match to the transmitter's RF output. Ideal for most CB installations.
2:1 – 3:1	Good	The antenna/cable system will perform to specification under most normal conditions.
Higher than 3:1:1	Inefficient	Indicates a need to inspect the system, the mounting of the antenna and all pertinent hardware.

Prolonged exposure to salt spray, humidity, weather-induced corrosion, or vehicle vibration can cause antenna performance to degrade with a subsequent rise in the SWR. Anytime you notice that the SWR reading is greater than 3:1, check the condition of the antenna, the antenna cable and all antenna connectors and hardware.

## A QUICK LOOK AT THE CONTROLS

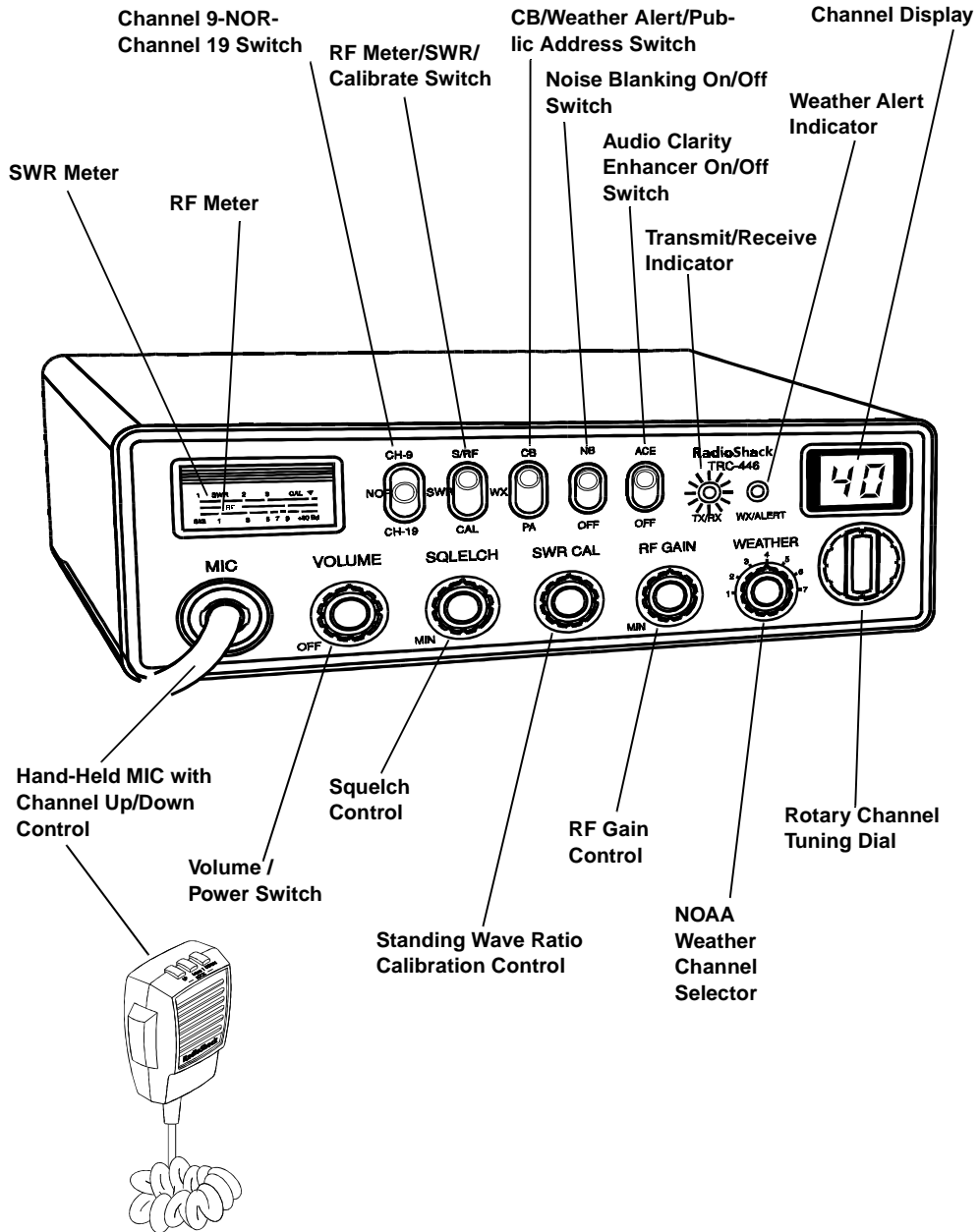

## OPERATION

Before you start using your CB, you should know how to use it effectively and courteously. "CB Operation Tips" on Page 15 contains information that will help you get more enjoyment from using your CB.

### TURNING ON THE CB AND RECEIVING TRANSMISSIONS

1. Turn **SQUELCH** fully counterclockwise.
2. Set **CH-9/NOR/CH-19** to **NOR**, **S/R/F/SWR/CAL** to **S/R/F** (send and receive), and **CB/WX/PA** to **CB**.
3. To turn on the CB, turn **OFF/VOLUME** clockwise until it clicks and you hear a hissing sound. TX/RX lights, the CB displays the last-tuned channel number, and the SWR/RF/Signal Meter lights.

4. Turn **SQUELCH** clockwise until the hissing sound stops.

**Note:** If the CB picks up unwanted, partial or very weak transmissions, continue to turn **SQUELCH** clockwise to decrease the CB's sensitivity to these signals. Turn **SQUELCH** counterclockwise if you want to listen to a weak or distant station.

5. Adjust **OFF/VOLUME** to a comfortable listening level.

6. To manually tune channels, turn the tuning control beneath the display to select a channel. The selected channel number appears, and the SWR/RF/Signal Meter shows the signal strength.

To quickly tune to Channel 9 or 19, set **CH-9/NOR/CH-19** to **CH-9** or **CH-19**. 9 or 19 flashes.

**Important:** Always give emergency communications priority on Channels 9 and 19. Your CB provides for fast selection of Channel 9 and 19 for that reason.

#### Notes:

- Selecting either Channel 9 or 19 overrides the manual channel selection control.
  - All channels, with the exception of Channels 9 and 19, by agreement, are available for general communications. Channels 9 and 19 are reserved for motorist assistance and for reporting emergency situations, hazardous road conditions, and the like.
7. If necessary, turn **RF GAIN** clockwise to boost the strength of a signal.
  8. If you hear low-level popping-type noise, set **NB/OFF** to **NB** to turn on the noise blanking circuit.
  9. To improve communication quality, set **ACE/OFF** to **ACE**. This enables the ACE circuit.
  10. To turn off the TRC-446, turn **OFF/VOLUME** counterclockwise until you hear it click.

## Changing Channels Using the Controls on the Microphone

To tune to the next higher or lower channel, press **UP** or **DOWN** on the microphone.

To quickly change channels in either direction, hold down **UP** or **DOWN** until you reach the desired channel.

To prevent accidentally changing the channel with **UP** or **DOWN**, press **LOCK**. Press **LOCK** again to restore the **UP** or **DOWN** operation.

4. To turn off the TRC-446, turn **OFF/VOLUME** counterclockwise until you hear it click.

## LISTENING TO WEATHER BROADCASTS

The TRC-446 can receive seven pre-programmed weather channels which have been allocated by the Federal Communications Commission (FCC) for use by the National Oceanographic and Atmospheric Administration (NOAA). NOAA broadcasts your local forecast and regional weather information on one or more of these channels in your area.

Your TRC-446 receives these weather service frequencies:

Frequency (MHz)	Channel
162.400	WX2
162.425	WX4
162.450	WX5
162.475	WX3
162.500	WX6
162.525	WX7
162.550	WX1

## TRANSMITTING

**Note:** We recommend you try receiving transmissions before you transmit.

1. Follow Steps 1–9 under “Turning On the CB and Receiving Transmissions” on Page 12.
2. Hold down the microphone's talk button and speak into the microphone in a normal voice from about 2–3 inches away. TX/RX turns red, and the SWR/RF/signal meter indicates the strength of your transmission.

**Note:** Do not speak too loudly when transmitting. It does not make your signal any stronger, and might distort your transmission.

3. When you finish transmitting, release the microphone talk button. TX/RX turns green. The TRC-446 can now receive transmissions.

To listen to one of the seven available weather channels, set **CB/WX/PA** to **WX**, then rotate **WEATHER** to choose a channel for your listening area. The channel display and the SWR turn off. Readjust **OFF/VOLUME** if necessary.

**Note:** When the CB radio is set to **CB** or **PA**, and you enter a NOAA broadcast area, the state of the **WX/ALERT** indicates three possible situations:

**OFF** — No weather signal on the selected weather channel. Check another channel.

**GREEN** — Normal weather signal. No emergency broadcast.

**ORANGE** — Weather alert broadcast on the selected channel. Turn to **WX** to listen to information or power off then on to clear the alert.

### Weather Alert

In the event of severe weather conditions, the National Weather Service broadcasts a special 1050 Hz tone. The TRC-446 sounds this tone if it is turned on and **CB/WX/PA** is set to **CB** or **WX**. The tone does not sound if the radio is set to **PA**. When the radio receives this signal tone, **WX/ALERT** lights orange regardless of the position of **CB/WX/PA**.

NOAA transmits this tone for 5 to 10 seconds. If the TRC-446 is set to **CB** or **PA**, the orange light remains on even after transmission ceases. You do not have to be present when the signal is received to be aware of an alert.

However, **WX/ALERT** turns off if you turn to **WX** or move out of the range of that NOAA channel. To turn off the indicator you can also turn power off, then on.

The orange indicator means switch to **WX** to hear special severe weather information and warnings.

### USING THE PUBLIC ADDRESS FUNCTION

1. Connect a PA speaker to the TRC-446 (see "Connecting Optional External Speakers" on Page 8).
2. Turn **OFF/VOLUME** fully counterclockwise.
3. Set **CB/WX/PA** to **PA**. The meter and TX/RX turn off.
4. Hold down the microphone talk button and speak into the microphone in a normal voice. Be sure the microphone is as far from the PA speaker as possible to reduce the possibility of audio feedback or howl.
5. Adjust **OFF/VOLUME** as needed to adjust the PA's volume.



## CB OPERATION TIPS

---

Like most activities, CB radio users have customs and courtesies. The following tips will help you get the most enjoyment out of your CB.

### TYPICAL USES FOR A CB RADIO

#### Business Uses

- Truck drivers and delivery personnel can learn road and traffic conditions and get assistance in locating destinations. A CB is also good company on these “long hauls.”
- Used by construction crews, a CB quickly pays for itself when you are calling for additional materials or coordinating the activities of different work crews.
- For security officers, a CB is more than a convenience — it is a must for both safety and efficiency.

#### Personal Uses

- Keep in touch with home while driving to work, to the store, or to a social activity. Let your family know you are tied up in traffic or that you will stop by the store on the way home.
- If you are a two-or-more car family, CBs are great for inter-car communications while family members are going places.

- Contact friends or neighbors — find out “what’s happening” or plan a get-together.
- Ever have car trouble or run out of gas on the highway? With your CB you can have peace of mind knowing you can call for assistance.
- Camping, fishing, and other sports are more fun with a CB. Keep in touch with a buddy or find out “what’s cooking” back at camp.

#### CB Courtesy

- Wait for a pause in someone else's transmission before you ask for a break.
- If you do not receive an answer to your call after a second attempt, sign off and wait several minutes before trying again.
- Do not hold down the microphone talk button, called “dead keying”, when you are talking.
- Assist callers with directions, information about road conditions, and any other reasonable requests.

## USING COMMON 10-CODES

Citizen's band operators have largely adopted the following 10-codes for standard questions and answers. These codes permit faster and more precise communication in noisy areas. This table lists codes adopted by the Associated Public-Safety Communications Officers (APCO).

Code	Meaning
10-1	Your signal is bad.
10-2	Your signal is good.
10-3	Stop transmitting.
10-4	Message received and understood.
10-5	Relay information to _____.
10-6	I am busy or are you busy?
10-7	Out of service.
10-8	In service.
10-9	Repeat last message.
10-10	Negative (NO).
10-11	_____ in service.
10-12	Stand by.
10-13	Report road/weather conditions.
10-14	Information.
10-15	Message delivered.
10-16	Reply to message.
10-17	En route.
10-18	Urgent
10-19	Contact _____
10-20	What's your location?

Code	Meaning
10-21	Call _____ by telephone.
10-22	Cancel last message.
10-23	Arrived at the scene.
10-24	Assignment complete.
10-25	Meet _____.
10-26	Estimated time of arrival is _____
10-30	Use caution.
10-31	Pick up.
10-33	Emergency traffic. Clear the channel.
10-34	What time is it?
10-41	Switch to Channel -
10-62	Cannot understand.

**Note:** Although this table lists the 10-codes' meanings in the form of a statement, they can also be phrased as questions (10-6: Are you busy?, 10-20: What is your location?).



---

---

## MAXIMUM RANGE

The maximum range and quality of CB transmissions vary depending on the following typical conditions:

- The type and quality of antenna used.
- The height of the antenna's mounting location — the higher the antenna, the greater the signal's range
- The surrounding terrain — mountains and tall buildings limit the range.
- Weather conditions.
- The number of nearby CBs operating on the same channel.

## REDUCING NOISE

The audio clarity enhancer (ACE) circuit uses compander (compressor and expander) technology to improve communication quality. The circuit maintains the dynamic range while increasing the signal-to-noise ratio as the gain is automatically controlled according to the input signal level. This results in a reduction in wide band noise.

The noise blanking (NB) circuit helps keep background noise to a minimum. However, strong sources of electrical noise, generated by spark plugs or the ignition of your car, or another radio, might be more than the circuit can compensate for.

If you suspect engine noise as a source, turn off the engine and operate the CB with the ignition set to ACC. If most or all of the noise stops, the problem is in vehicle's ignition or electrical system.

The following few hints can help you reduce or eliminate such noise.

- Replace old ignition wires with new, high-voltage, noise-suppression wires.
- Install noise suppressors on your spark plugs, or install new spark plugs that have built-in suppressors.
- Be sure that the black wire ground connection is securely attached to either your vehicle's battery's negative (GND) terminal or to a good electrical chassis ground.

If problems persist, check your alternator or generator, voltage regulator, and any stand-alone gauges. Noise from these sources can be reduced or eliminated using bypass capacitors at various output voltage points.

Your local RadioShack store has a wide selection of noise-suppression accessories.

## TROUBLESHOOTING

If your CB is not working as it should, follow the suggestions below to see if you can eliminate the problem. If the problem persists, take the CB to your local RadioShack store for assistance.

Symptom	Check That:
Reception difficulties	<b>OFF/VOLUME</b> is turned on.
	<b>CB/WX/PA</b> is set to <b>CB</b>
	<b>OFF/VOLUME</b> is at a sufficient listening level.
	<b>RF GAIN</b> is set to the correct level.
	The microphone is securely plugged into <b>MIC</b> .
	The antenna cable is securely plugged into <b>ANTENNA</b> on the rear of the radio and attached securely to the antenna at the other end.
Transmission difficulties	The CB is turned on.
	<b>OFF/VOLUME</b> is at a sufficient listening level.
	The microphone is securely plugged into <b>MIC</b> .
	All connectors (microphone, antenna, speakers) are tight and secure.
	When transmitting, you are fully pressing the microphone talk button.
	The antenna is properly mounted and not obstructed or grounded.
No channel selection or only Channel 9 or 19 can be selected.	<b>CB/WX/PA</b> is set to <b>CB</b>
	<b>CH9/NOR/CH-19</b> is set to <b>NOR</b>
No operation at all.	The power supply and in-line fuse are functioning ("Replacing the Fuses" on Page 20)

## CARE AND MAINTENANCE

---

Your RadioShack TRC-446 Deluxe 40-Channel Mobile CB is an example of superior design and craftsmanship. The following suggestions will help you care for your TRC-446 so you can enjoy it for years.



Keep the CB dry. If it gets wet, wipe it dry immediately. Liquids might contain minerals that can corrode the electronic circuits.



Use and store the CB only in normal temperature environments. Temperature extremes can shorten the life of electronic devices, and distort or melt plastic parts.



Keep the CB away from dust and dirt, which can cause premature wear of parts.



Handle the CB gently and carefully. Dropping it can damage circuit boards and cases and can cause the CB to work improperly.



Wipe the CB with a damp cloth occasionally to keep it looking new. Do not use harsh chemicals, cleaning solvents, or strong detergents to clean the CB.

Modifying or tampering with the CB's internal components can cause a malfunction and might invalidate its warranty and void your FCC authorization to operate it. If your CB is not performing as it should, take it to your local RadioShack store for assistance.

---

## REPLACING THE FUSES

The TRC-446's 2-amp fuses help protect your CB from power surges and short circuits.

- *If the red wire's fuse is blown,* replace it with a 2-amp, fast-acting glass fuse, such as Cat. No. 270-1007.
- *If the orange wire's fuse is blown,* replace it with a 1-amp, fast-acting glass fuse, such as Cat. No. 270-1005.

Follow these steps to replace each fuse.

1. Make sure the power source and CB are both off.
2. To open the fuse holder, push the fuse holder ends together, then turn either end counterclockwise and release it.
3. If the fuse is blown, replace it.

**Caution:** Do not use a fuse with ratings other than those specified here. Doing so might damage your TRC-446.

4. Close the fuse holder by pushing the fuse holder ends together, then turn either end clockwise.

## **SPECIFICATIONS**

---

---

### **GENERAL**

Channels ..... 40 Channels  
Frequency Range ..... 26.965 MHz to 27.405 MHz  
Power Requirements ..... 13.8V DC (12–16 Volts DC, Negative Ground)  
Dimensions (HWD) .....  $2\frac{1}{4} \times 7\frac{1}{4} \times 7\frac{7}{8}$  Inches  
(57 × 184 × 200 mm)  
Weight ..... 3.1 lbs (1.4 kg)

### **RECEIVER**

Sensitivity ..... 0.5  $\mu$ V or better for 10 dB (S+N)/N  
Adjacent Channel Rejection ..... 50 dB (at 10 kHz)  
Audio Output ..... 4.5 Watts (Maximum)  
Frequency Response ..... 450–2500 Hz  
Intermediate Frequency ..... 1st IF: 10.695 MHz  
2nd IF: 455 KHz  
Cross Modulation ..... 50 dB  
Squelch ..... Adjustable from 0.5  $\mu$ V to 1 mV

### **TRANSMITTER**

Output Power ..... 4 Watts (FCC Maximum)  
Type of Modulation ..... AM Double-Sideband, Full Carrier Modulation  
Modulation Capability .....  $\pm 90\%$   
Spurious Emission ..... Less than  $-70$  dB  
Frequency Tolerance .....  $\pm 200$  Hz  
Antenna Impedance ..... 50 Ohm  
Current Drain ..... (13.8-volt supply) 1 Amp with No Modulation  
1.6 Amps with 80% Modulation



---

---

## PUBLIC ADDRESS

Output Power ..... 4.2 Watts (Maximum)

Current Drain (at maximum power) ..... 1.2 Amps

## WEATHER RADIO

Frequency Coverage (MHz) ..... 162.400  
162.425  
162.450  
162.475  
162.500  
162.525  
162.550

Specifications are typical; individual units might vary. Specifications are subject to change and improvement without notice.

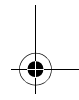
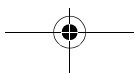
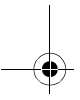
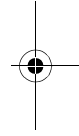
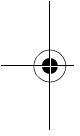

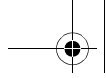

# NOTES

---

---

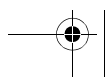
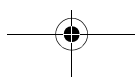
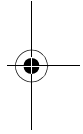
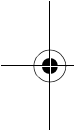

### Limited Ninety-Day Warranty

This product is warranted by RadioShack against manufacturing defects in material and workmanship under normal use for ninety (90) days from the date of purchase from RadioShack company-owned stores and authorized RadioShack franchisees and dealers. EXCEPT AS PROVIDED HEREIN, RadioShack MAKES NO EXPRESS WARRANTIES AND ANY IMPLIED WARRANTIES, INCLUDING THOSE OF MERCHANTABILITY AND FITNESS FOR A PARTICULAR PURPOSE, ARE LIMITED IN DURATION TO THE DURATION OF THE WRITTEN LIMITED WARRANTIES CONTAINED HEREIN. EXCEPT AS PROVIDED HEREIN, RadioShack SHALL HAVE NO LIABILITY OR RESPONSIBILITY TO CUSTOMER OR ANY OTHER PERSON OR ENTITY WITH RESPECT TO ANY LIABILITY, LOSS OR DAMAGE CAUSED DIRECTLY OR INDIRECTLY BY USE OR PERFORMANCE OF THE PRODUCT OR ARISING OUT OF ANY BREACH OF THIS WARRANTY, INCLUDING, BUT NOT LIMITED TO, ANY DAMAGES RESULTING FROM INCONVENIENCE, LOSS OF TIME, DATA, PROPERTY, REVENUE, OR PROFIT OR ANY INDIRECT, SPECIAL, INCIDENTAL, OR CONSEQUENTIAL DAMAGES, EVEN IF RadioShack HAS BEEN ADVISED OF THE POSSIBILITY OF SUCH DAMAGES.

Some states do not allow the limitations on how long an implied warranty lasts or the exclusion of incidental or consequential damages, so the above limitations or exclusions may not apply to you.

In the event of a product defect during the warranty period, take the product and the RadioShack sales receipt as proof of purchase date to any RadioShack store. RadioShack will, at its option, unless otherwise provided by law: (a) correct the defect by product repair without charge for parts and labor; (b) replace the product with one of the same or similar design; or (c) refund the purchase price. All replaced parts and products, and products on which a refund is made, become the property of RadioShack. New or reconditioned parts and products may be used in the performance of warranty service. Repaired or replaced parts and products are warranted for the remainder of the original warranty period. You will be charged for repair or replacement of the product made after the expiration of the warranty period.

This warranty does not cover: (a) damage or failure caused by or attributable to acts of God, abuse, accident, misuse, improper or abnormal usage, failure to follow instructions, improper installation or maintenance, alteration, lightning or other incidence of excess voltage or current; (b) any repairs other than those provided by a RadioShack Authorized Service Facility; (c) consumables such as fuses or batteries; (d) cosmetic damage; (e) transportation, shipping or insurance costs; or (f) costs of product removal, installation, set-up service adjustment or reinstallation.

This warranty gives you specific legal rights, and you may also have other rights which vary from state to state.

RadioShack Customer Relations, 200 Taylor Street, 6th Floor, Fort Worth, TX 76102

*We Service What We Sell*

04/99

**RadioShack**  
**A Division of Tandy Corporation**  
**Fort Worth, Texas 76102**

05A99

937485  
Printed in Thailand