

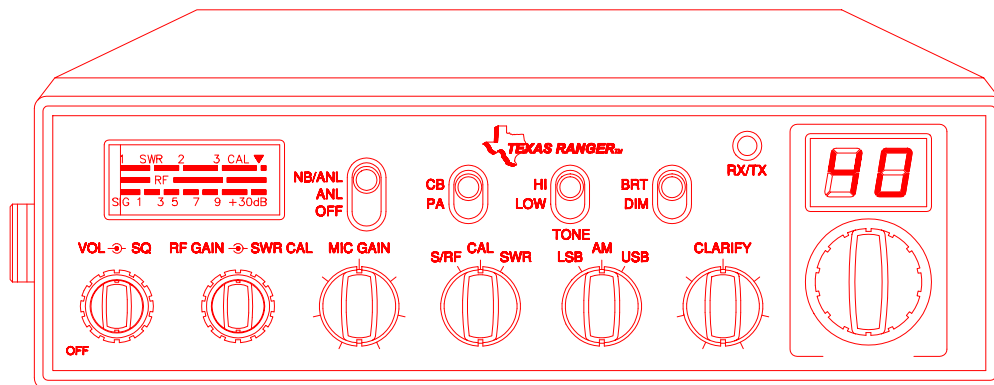

CB Radios

TR-296GK / TR-296DX Service Manual





	PAGE
CHAPTER 1	
SPECIFICATIONS	
1.0 General	2
1.1 Transmitter	2
1.2 Receiver	2
 CHAPTER 2	
OPERATION	
2.0 Introduction	3
2.1 Control & Connections	3
2.1.1 Front Panel	3
2.1.2 Rear Panel	5
2.1.3 Frequency Chart	6
2.2 Microphone	7
2.3.1 Procedure To Receive	7
2.3.2 Procedure To Transmit	7
2.4 Alternate Microphones And Installation	7
 CHAPTER 3	
CIRCUIT DESCRIPTION	
3.0 Introduction	9
3.1 PLL Circuit	9
3.2 Receiver Circuit	9
3.3 Transmitter Modulation Circuit	9
3.4 Transmitter Amplifier Circuit	9
 CHAPTER 4	
ALIGNMENT	
4.0 Required Test Equipment	11
4.1 Alignment Procedures	11
4.1.1 PLL Alignment	11
4.1.2 Transmitter Alignment	12
4.1.3 Receiver Alignment	13
 CHAPTER 5	
MAINTENANCE	
5.0 Precautions	16
5.1 Periodic Inspection	16
5.2 Fuse Replacement	16
 CHAPTER 6	
DIAGRAMS AND PART LIST	
6.0 PCB Layout & Part List	17

1.0 GENERAL

Model	TR-296GK / TR-296DX (B),(C)
Frequency Range	26.965 - 27.405MHz.
Emission Modes	AM/USB/LSB
Frequency Control	Phase Lock Loop (PLL) synthesizer.
Frequency Tolerance	± 0.005 %.
Frequency Stability	± 0.001 %.
Operating Temperature Range	-30°C to +50°C.
Microphone	Plug-in dynamic; with push-to-talk switch and coiled cord.
Input Voltage	13.8V DC nominal ±15%.
Current Drain: Transmit (AM full mod.)	<3.5A.
Current Drain: Receiver (Squelched)	<0.5A.
(Max. audio output)	<1.0A.
Antenna Connector	UHF, SO239.
Dimensions	2-3/8"(H) x 7-7/8"(W) x 9-1/4"(D).
Weight	5 lb.

1.1 TRANSMITTER

RF Power Output	AM : 4W ; USB/LSB : 12W PEP
RF Transmit Modes	AM/USB/LSB
Modulation	High and low level Class B, Amplitude Modulation: AM and SSB.
Spurious Emissions	-55 dB.
Carrier Suppression	-55 dB.
Audio Frequency Response	300 to 2500 Hz
Antenna Impedance	50 Ohms.
Output Indicators	Meter shows relative RF output power, signal strength and SWR. Transmit LED glows red when transmitter is in operation.

1.2 RECEIVER

Sensitivity For 10dB S/N (AM)	<0.5 μV.
Sensitivity For 10dB S/N (SSB)	<0.25 μV.
IF Frequency	AM: 10.695 MHz 1st IF, 455 KHz 2nd IF.
Image Rejection	-65 dB.
Adjacent Channel Selectivity	-60 dB.
RF Gain Control	45 dB adjustable for optimum signal reception.
Automatic Gain Control (AGC) Figure Of Merit	100 mV for 10 dB Change in Audio Output.
Squelch	Adjustable; threshold less than 0.5 μV.
Noise Blanker	RF type.
Audio Output Power	4 watts into 8 Ohms.
Audio Frequency Response	AM and SSB: 300 to 2500 Hz.
Built-in Speaker	8 Ohms, 5 Watts.
External Speaker (Not Supplied)	8 Ohms; disables internal speaker when connected.

(SPECIFICATIONS SUBJECT TO CHANGE WITHOUT NOTICE)

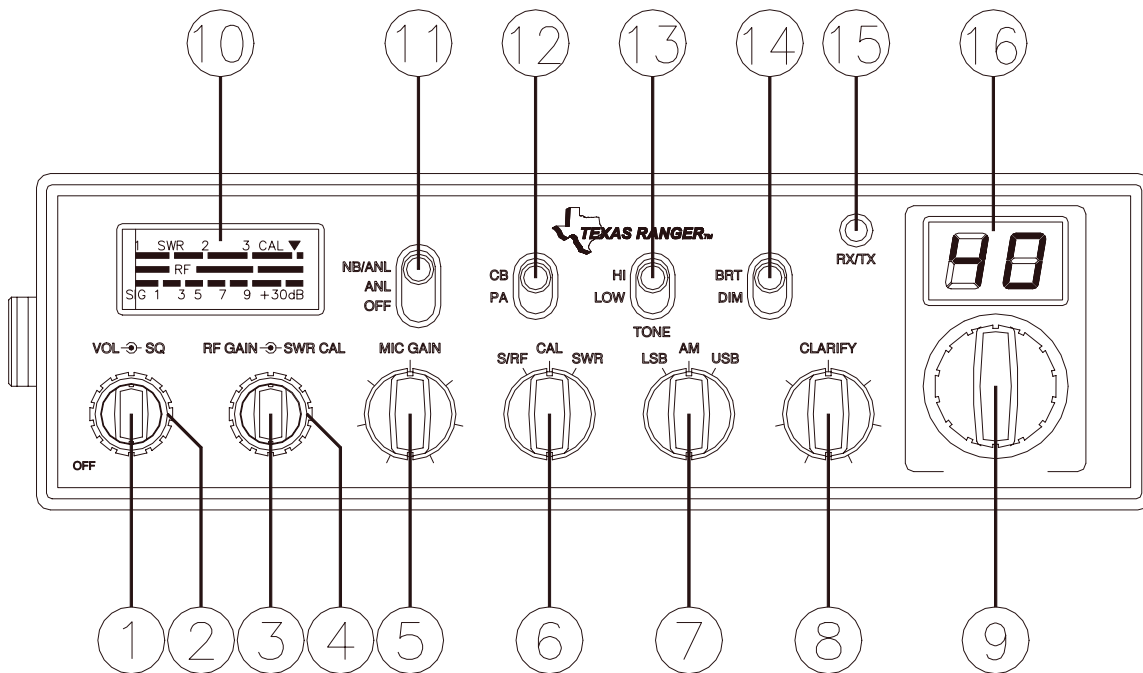

Figure 2-1 Front Panel

2.0 INTRODUCTION

This section explains the basic operating procedures for the TEXAS RANGER TR-296GK / TR-296DX mobile transceiver.

2.1 CONTROLS AND CONNECTIONS

2.1.1 FRONT PANEL

Refer to the above Figure 2-1 for the location of the following controls.

1. ON/OFF VOLUME CONTROL

Turn clockwise to apply power to the radio and to set the desired listening level.

2. SQUELCH CONTROL

This control is used to control or eliminate receiver background noise in the absence of an incoming signal. For maximum receiver sensitivity, it is desired that the control be adjusted only to the point where the receiver background noise is eliminated. Turn fully counter-clockwise, then slowly clockwise until the receiver noise disappears. Any signal to be received must now be slightly stronger than the average received noise. Further clockwise rotation will increase the threshold level which a signal must overcome in order to be heard. Only strong signals will be heard at a maximum clockwise setting.

3. RF GAIN CONTROL

This control is used to reduce the gain of the receive amplifier under strong signal conditions.

4. SWR CAL CONTROL

This SWR CAL control allows the user to calibrate the SWR meter.

5. MIC GAIN CONTROL

Adjusts the microphone gain in the transmit and PA modes. This controls the gain to the extent that full talk power is available several inches away from the microphone. In the Public Address (PA) mode, the control functions as the volume control.

6. S-RF/CAL/SWR SWITCH

In the S-RF position, the meter swings proportionally to the strength of the received signal. When transmitting, the meter indicates relative RF output power. When in the CAL position, the SWR meter can be calibrated by adjusting the SWR CAL control. When in the SWR position, the Standing Wave Ratio is measured.

7. MODE CONTROL

This control allows you to select one of the following operating modes: LSB/AM/USB.

8. CLARIFY CONTROL

Allows tuning of the receive frequency above or below the channel frequency by up to 1.5 KHz. Although this control is intended primarily to tune in SSB signals, it may be used to optimize AM signals.

9. CHANNEL SELECTOR

This control is used to select a desired transmit and receive channel.

10. FRONT PANEL METER

The Front Panel Meter allows the user to monitor signal strength, RF output power and SWR level.

11. NB/ANL/OFF SWITCH

In the ANL position, the automatic noise limiter in the audio circuits is activated. When the switch is placed in the NB/ANL position, the RF noise blanker is also activated. The noise blanker is very effective in eliminating repetitive impulse noise such as ignition interference.

12. CB/PA SWITCH

The CB is a normal operation of the radio. In the CB position, the PA function is disabled and the unit will transmit and receive on the speaker that is connected. In the PA position, the radio acts as a public address amplifier. Your voice will come out of the speaker that have plugged in to the PA. SP. jack on the rear panel. The radio does not operate when you are in the PA mode.

13. TONE HI/LO SWITCH

This switch is used to shape the tone of the received signal. In LO position, bass is increased and in HI position, treble is increased.

14. BRIGHT/DIM SWITCH

This switch controls the level of brightness for the meter lamp and channel display LED.

15. TX/RX LED

The red LED indicates the unit is in the transmit mode. The green LED indicates the unit is in the receive mode.

16. CHANNEL DISPLAY

The channel display indicates the current selected channel.

2.1.2 REAR PANEL

Figure 2-2 represent the location of the following connections:

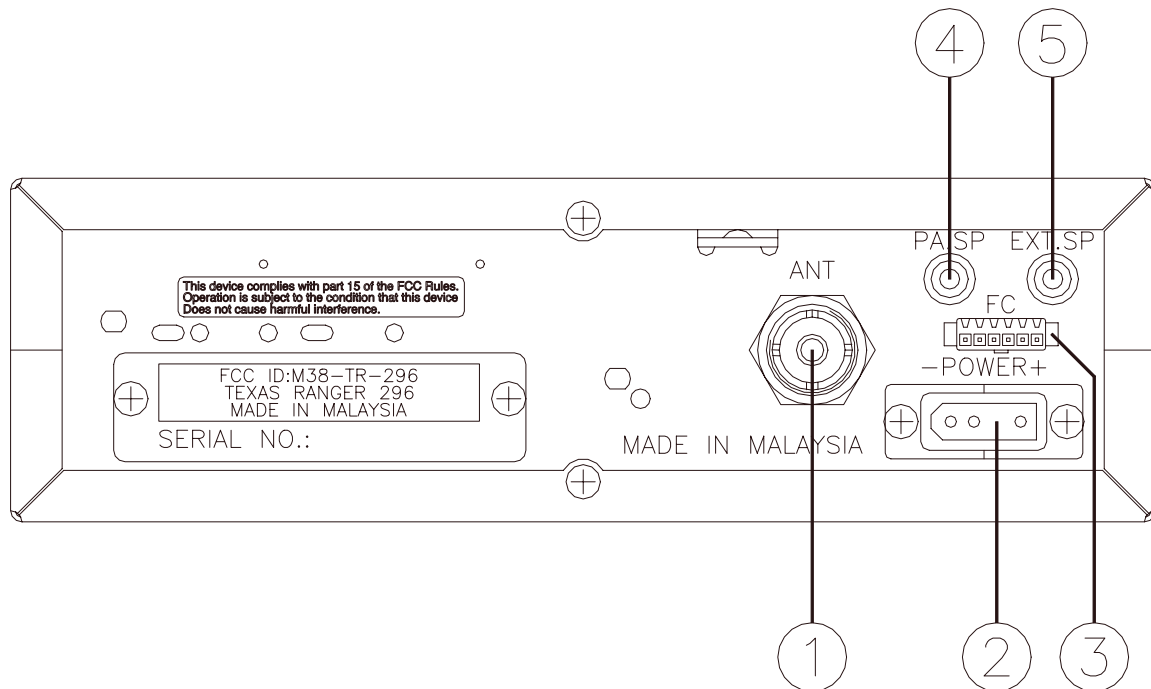

Figure 2-2 Rear Panel

1. ANTENNA

This jack accepts 50 ohms coaxial cable with a PL-259 type connector.

2. POWER

This connector accepts 13.8V DC power cable with built-in fuse. The power cord provided with the radio has a black and red wire. The black goes to negative and the red goes to positive.

3. FREQUENCY COUNTER CONNECTOR

This F. C. connector is used for an external frequency counter which indicates the frequency of the selected channel.

4. PA. SP.

This jack is for PA operation. Before operating, you must first connect a PA speaker (8 ohms, 4W) to this jack.

5. EXT. SP.

This jack accepts 4 to 8 ohms, 5 watts external speaker. When the external speaker is connected to this jack, the built-in speaker will be disabled.

2.1.3 FREQUENCY CHART

CHANNEL	CHANNEL FREQUENCY	CHANNEL	CHANNEL FREQUENCY
---------	-------------------	---------	-------------------

1	26.965	MHz	21	27.215	MHz
2	26.975	MHz	22	27.225	MHz
3	26.985	MHz	23	27.255	MHz
4	27.005	MHz	24	27.235	MHz
5	27.015	MHz	25	27.245	MHz
6	27.025	MHz	26	27.265	MHz
7	27.035	MHz	27	27.275	MHz
8	27.055	MHz	28	27.285	MHz
9	27.065	MHz	29	27.295	MHz
10	27.075	MHz	30	27.305	MHz
11	27.085	MHz	31	27.315	MHz
12	27.105	MHz	32	27.325	MHz
13	27.115	MHz	33	27.335	MHz
14	27.125	MHz	34	27.345	MHz
15	27.135	MHz	35	27.355	MHz
16	27.155	MHz	36	27.365	MHz
17	27.165	MHz	37	27.375	MHz
18	27.175	MHz	38	27.385	MHz
19	27.185	MHz	39	27.395	MHz
20	27.205	MHz	40	27.405	MHz

2.2 MICROPHONE

The receiver and transmitter are controlled by the push-to-talk switch on the microphone. Press the switch and the transmitter is activated, release switch to receive. When transmitting, hold the

microphone two inches from the mouth and speak clearly in a normal voice. The radio comes complete with a low impedance (500 ohm) dynamic microphone. For installation instructions of the microphone, see section 2.4 “ALTERNATE MICROPHONES AND INSTALLATION”.

2.3 OPERATION

2.3.1 PROCEDURE TO RECEIVE

1. Be sure that power source, microphone and antenna are connected to the proper connectors before going to the next step.
2. Turn unit on by turning **VOL** knob clockwise on transceiver.
3. Set the **VOL** to a comfortable listening level.
4. Set the **MODE** switch to the desired mode.
5. Listen to the background noise from the speaker. Turn the **SQ** knob slowly clockwise until the noise just disappears. The **SQ** is now properly adjusted. The receiver will remain quiet until a signal is actually received. Do not advance the control too far or some of weaker signals will not be heard.
6. Set the **CHANNEL** selector switch to the desired channel.
7. Set the **RF GAIN** control fully clockwise for maximum receive gain.
8. Adjust the **CLARIFY** control to clarify the SSB signals or to optimize AM signals.

2.3.2 PROCEDURE TO TRANSMIT

1. Select the desired channel of transmission.
2. Set the **MIC GAIN** control fully clockwise.
3. If the channel is clear, depress the push-to-talk switch on the microphone and speak in a normal voice.

2.4 ALTERNATE MICROPHONES AND INSTALLATION

For best results, the user should select a low impedance dynamic type microphone or a transistorized microphone. Transistorized type microphones have a low output impedance characteristic. The microphones must be provided with a five-lead cable. The audio conductor and its shielded lead comprise two of the leads. The third lead is for receive control, the fourth is for grounding and fifth is for transmit control. The microphone should provide the functions shown in schematic below (Figure 2-3).

5 WIRE MIC CABLE

Pin Number	Mic Cable Lead
1	Audio Shield
2	Audio Lead
3	Receive Control
4	Grounding
5	Transmit Control

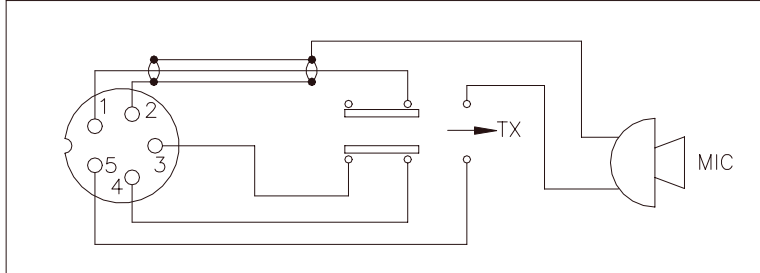

Figure 2-3 Transceiver Microphone Schematic

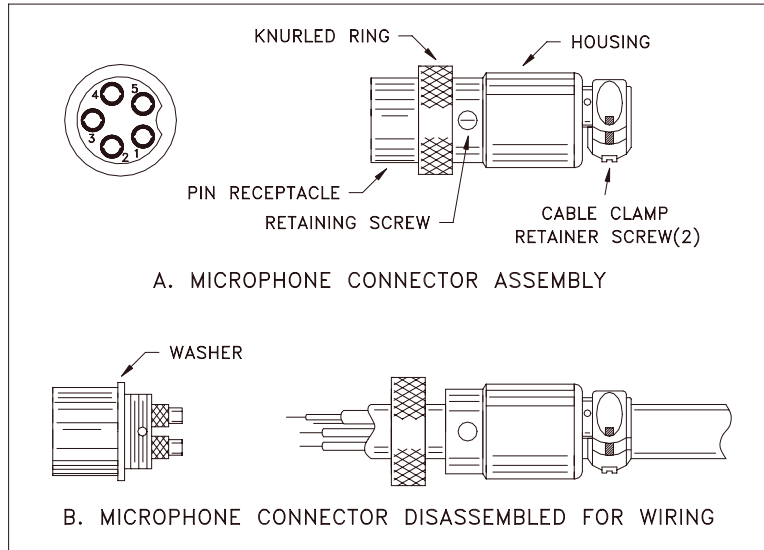

Figure 2-4 Microphone Plug Wiring

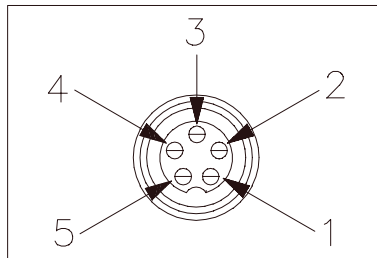

Figure 2-5 Microphone plug pin numbers viewed from rear of pin receptacle.

3.0 INTRODUCTION

This section explains the technical theory of operation for the TR-296GK / TR-296DX mobile transceiver.

3.1 PLL CIRCUIT

The Phase Lock Loop (PLL) circuit is responsible for developing the receiver's first local oscillator signal and the transmitter's exciter signal. The PLL circuit consists primarily of IC1, IC2, TR20, TR29 and TR30. The PLL circuit is programmed by the rotary channel switch GPS-0668. The GPS-0668 communicates the correct binary data information to the programmable divider inside of IC1. IC1 then controls the VCO (Voltage Controlled Oscillator) to oscillate on the correct frequency. This signal is fed either into the receiver's first mixer (for receive operation) or the transmitter's mixer (for transmit operation).

3.2 RECEIVER CIRCUIT

The incoming receive signal comes into the radio via the antenna and into the first RF amplifier, TR14. The RF signal is fed into the mixer, TR15 and then into the AM IF section of the receiver (depending on the mode of operation). The signal is then detected by either the AM detector or product detector and then fed to the audio amplifier section of the receiver and finally out to the speaker.

3.3 TRANSMITTER MODULATION CIRCUIT

- (i) The transmitter modulation circuit modulates the low level RF signal from the PLL exciter circuit with the user's audio voice signal from the microphone. The audio from the microphone is then amplified and fed into the balanced modulator circuit.
- (ii) If the transceiver is in the AM mode, the AF amplifier controls the gain of the last RF amplifier which produces a true AM signal.
- (iii) If the transceiver is in the SSB mode, the audio signal is mixed with 7.800MHz oscillator in IC3.

3.4 TRANSMITTER AMPLIFIER CIRCUIT

The transmitter takes the basic exciter signal from the TX mixer and amplifies it through a series of amplifiers consisting of TR39, TR38 and TR36 where it is sent out to the antenna connector.

TR-296GK/DX BLOCK DIAGRAM

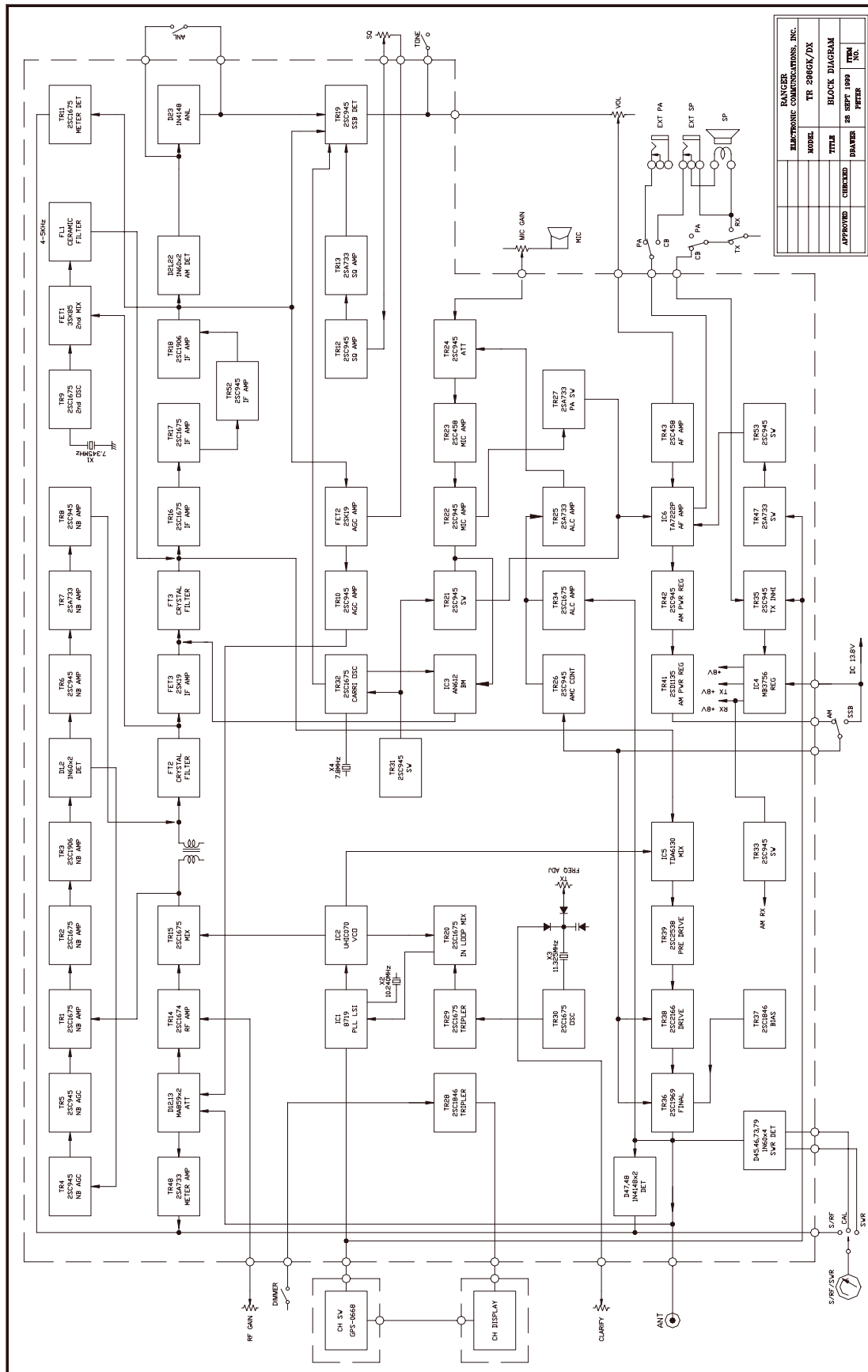

4.0 REQUIRED TEST EQUIPMENT

- | | |
|----------------------------------|---------------------------------|
| ① DC Power Supply (13.8VDC, 10A) | ⑥ Frequency Counter (100 MHz) |
| ② RF Wattmeter (25~60 MHz, 25W) | ⑦ RF Signal Generator (100 MHz) |
| ③ Multimeter | ⑧ Automatic Distortion Meter |
| ④ Automatic Modulation Meter | ⑨ Oscilloscope (50 MHz) |
| ⑤ Audio Signal Generator | ⑩ Sinad Meter |

4.1 ALIGNMENT PROCEDURES

This transceiver has been aligned at the factory and does not require any adjustments at installation. The required test equipment listed are used for the test setup or alignment shown in Figure 4-1 Transmitter Test Setup and Figure 4-2 Receiver Test Setup. These test setup are used in part or total during the following adjustments and refer to Figure 4-3 for adjustment location.

4.1.1 PLL ALIGNMENT

ITEM	U.U.T. SETTING	ADJUST POINT	MEASUREMENT
VCO Voltage	Set radio to CH 1, AM RX mode. Clarify setting in 12 o'clock position. Connect DC Voltmeter to TP9 (R207). Connect Oscilloscope to TP10 (R101). Connect Oscilloscope to TP1 (R106).	L19 L21 L20	2.5 VDC \pm 0.1 CH 1 & CH 40 Max. Output and Balance.
AM Frequency	Set radio to CH 1, AM RX mode. Connect frequency counter to TP1 (R106).	L23	34.76500 MHz \pm 20 Hz
LSB Freq.	Set radio to CH 1, LSB RX mode. Connect frequency counter to TP1 (R106).	L22	34.76350 MHz \pm 20 Hz
USB Freq.	Set radio to CH 1, USB RX mode. Connect frequency counter to TP1 (R106).	L59	34.76650 MHz \pm 20 Hz
TX Frequency	Set radio to CH 1, AM TX mode. Connect frequency counter to TP1 (R106).	VR5	34.76500 MHz \pm 20 Hz
AM TX Freq.	Set radio to CH 19, AM TX mode. Set Mic Gain fully counter clockwise.	L31	27.18500 MHz \pm 20 Hz
LSB TX Freq.	Set radio to CH19, LSB TX mode. Set Mic Gain fully clockwise. AF signal 25 mV, 1 KHz to microphone.	L30	27.18400 MHz \pm 20 Hz
USB TX Freq.	Set radio to CH19, USB TX mode. Set Mic Gain fully clockwise. AF signal 25 mV, 1 KHz to microphone.	CT2	27.18600 MHz \pm 20 Hz

4.1.2 TRANSMITTER ALIGNMENT

ITEM	U.U.T. SETTING	ADJUST POINT	MEASUREMENT
BIAS Current	Set radio to CH 19, USB TX mode. MOD off. Connect current meter to TP8 (+) and green lead wire (-). Connect current meter to TP7 (+) and violet lead wire (-).	VR9	30 mA
		VR8	50 mA
AM TX Power	Set radio to CH 19, AM TX mode. Connect RF power meter to antenna jack. MOD off.	L48, L47, L46, L45, L38, L36	RF Power Output MAX
		L38	Balance Power between CH 1 and CH 40.
		VR10	4W.
SSB ALC	Set radio to CH 19, USB TX mode. Set Mic Gain fully clockwise. AF signal 25 mV, 1 KHz to microphone.	VR11	12 W.
SSB Carrier Balance	Set radio to CH 19, USB TX mode. Connect Oscilloscope to L44 (TR39C). Mic Gain off.	VR4	Spurious Emission to minimum.
AM Modulation	Set radio to CH 19, AM TX mode. Set Mic Gain fully clockwise. AF signal 30 mV, 1 KHz to microphone.	VR7	95%
RF Power Meter	Set radio to CH 19, AM TX mode. MOD off.	VR6	Adjust RF Power meter needle until it is in-between the green and red bar on PWR scale.

4.1.3 RECEIVER ALIGNMENT

ITEM	SETTINGS	ADJUST	MEASUREMENT
------	----------	--------	-------------

		POINT	
AM Sensitivity	Set radio to CH 20, AM RX MODE. Clarify setting in 12 o'clock. Set RF gain fully clockwise. Set SQ fully counter clockwise. Set VOL control to 2 o'clock. Set NB/ANL to OFF position. Connect RF SG to antenna jack. Frequency 27.205 MHz, Level 1 uV. MOD 30%, 1KHz. Set radio to CH 40 AM mode. RF SG setting 27.405 MHz. Set radio to CH 1 AM mode. RF SG setting 26.965 MHz.	L13, L15, L3, L4, L5, L6, L7, L8, L9, L10	Audio output > 2V S/N > 10 dB
USB Sensitivity	Set radio to CH 20, USB RX mode. MOD off. Set VOL control fully clockwise. RF SG setting 27.206 MHz, Level 1 uV.	L12, L14	Audio output > 4.5V S/N > 20 dB
LSB Sensitivity	Set radio to CH 20, LSB RX mode. MOD off. VOL control fully clockwise. RF SG setting 27.204 MHz, Level 1 uV.	L12, L14	Audio output > 4.5V S/N > 20 dB
NB/ANL Adjust	Set radio to CH 20, AM RX mode. RF SG setting 27.205 MHz, Level 100 uV. MOD 30%, 1KHz. Set NB/ANL/OFF switch to NB/ANL. Connect Voltmeter to D2 (Cathode).	L1, L2	DC voltage to max. (>1.5V)
AM Squelch	Set radio to CH 20, AM RX mode. Set SQ control at fully clockwise. RF SG setting 27.205 MHz, Level 1 mV. MOD 30%, 1KHz.	VR3 Slowly	Adjust very slowly until quelch just open
AM S/RF Meter	Set radio to CH 20 AM RX mode. MOD off. Set S-RF/CAL/SWR switch to S/RF position. RF SG setting 27.205 MHz, Level 100 uV.	VR1	Meter needle to S9 on the S scale
SSB S/RF Meter	Set radio to CH 20, USB RX mode. MOD off. Set S-RF/CAL/SWR switch to S/RF position. RF SG setting 27.206 MHz, Level 100 uV	VR2	Meter needle to S9 on the S scale

Figure 4-1 Transmitter test setup

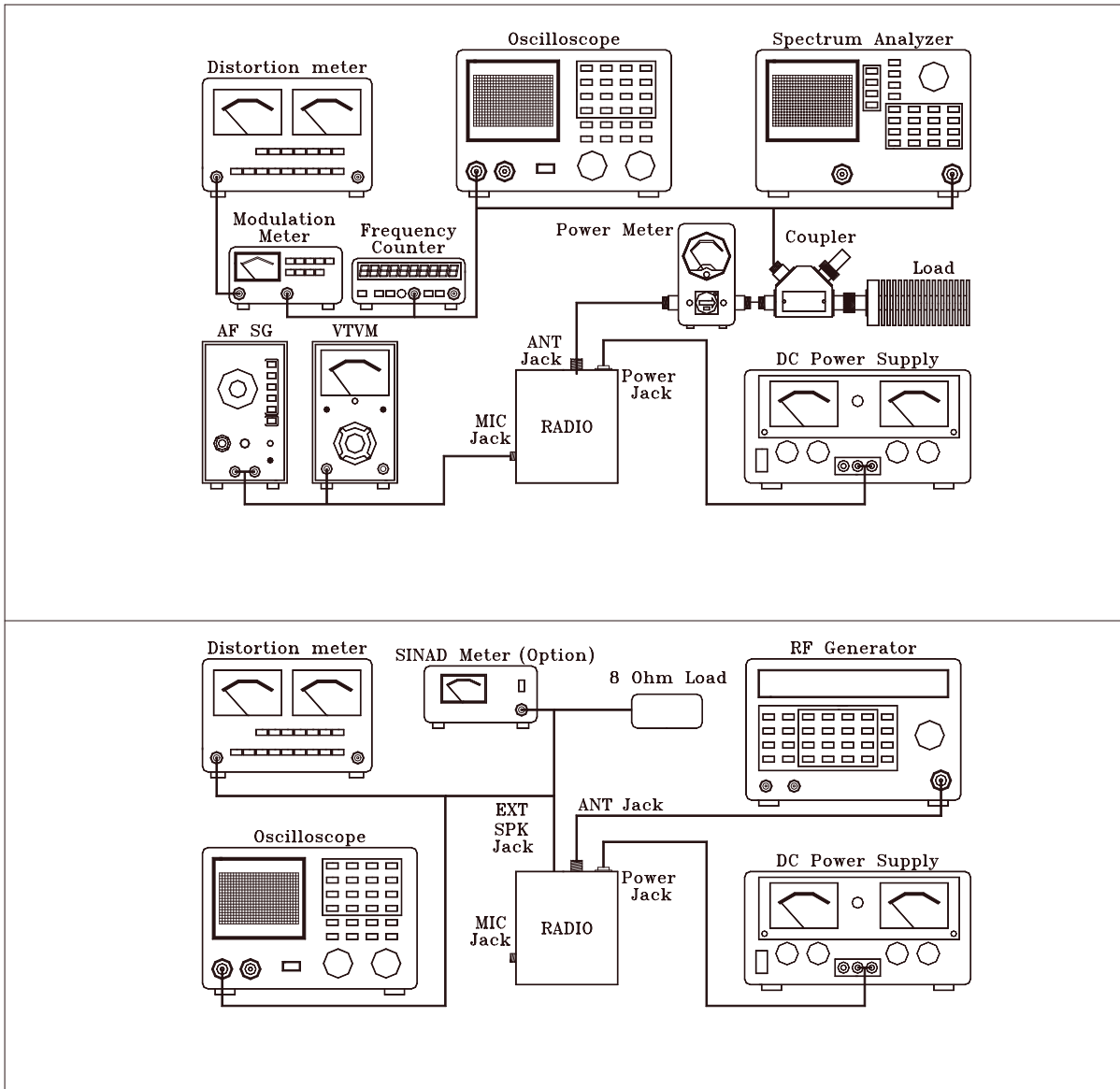

Figure 4-2 Receiver test setup

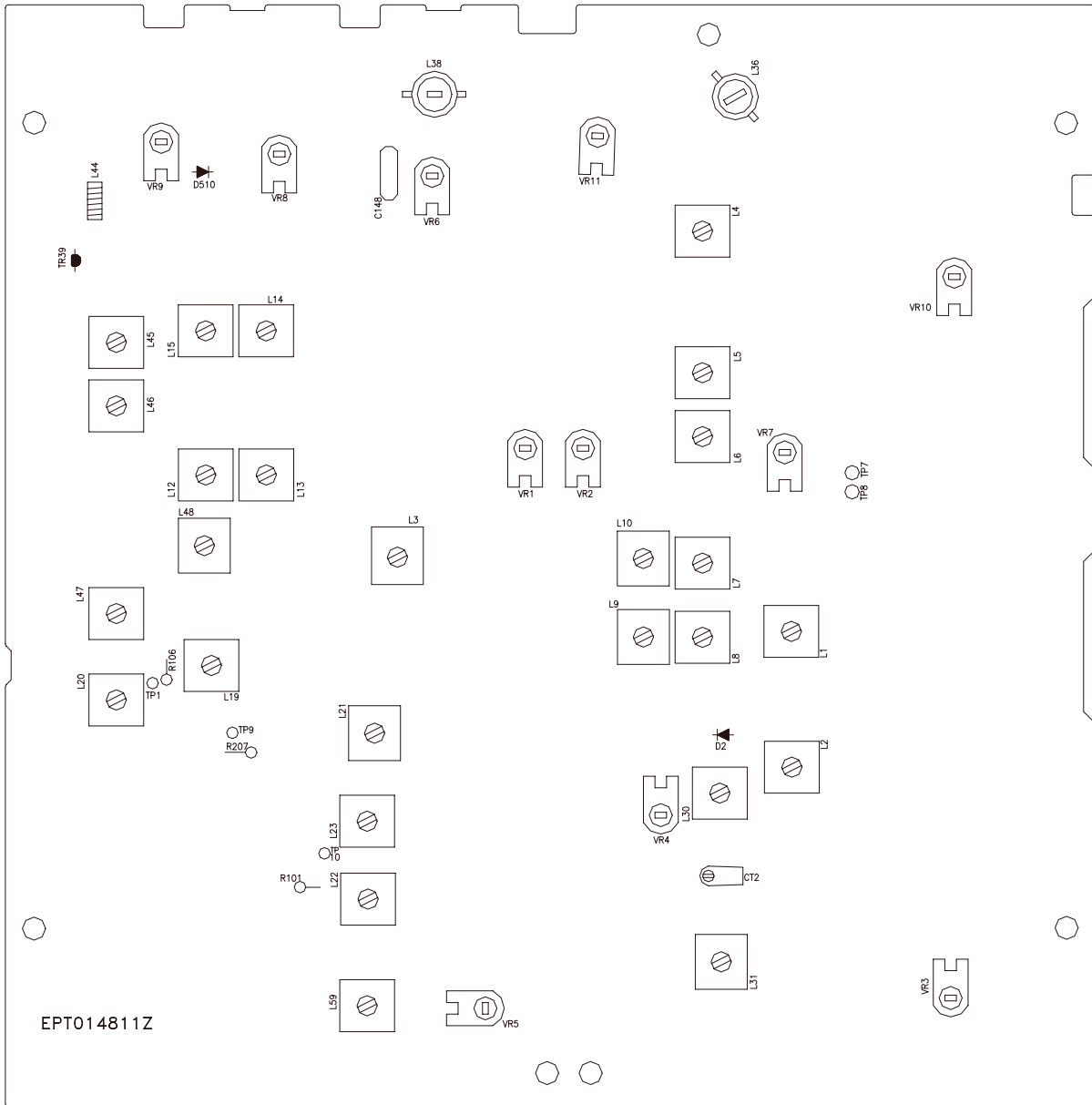

Figure 4-3 Main PCB Adjustment Location

CHAPTER 5

5.0 PRECAUTIONS

The inherent quality of the solid-state components used in this transceiver will provide many years of continuous use. Taking the following precautions will prevent damage to the transceiver.

- (i) Never key the transmitter unless an antenna or suitable dummy load is connected to the antenna receptacle.
- (ii) Ensure that the input voltage does not exceed 16 VDC or fall below 11 VDC.
- (iii) During alignment, do not transmit for more than 10 seconds at a time. Transmitting over long periods can cause heat built-up and cause transmitter damage.

5.1 PERIODIC INSPECTION

This unit is aligned at the factory to deliver maximum performance. However, continued performance cannot be expected without periodic inspection and maintenance. Important points to be checked regularly are as follows;

Check Item	Action
Whip antenna (option)	If cracked or broken, replace it.
Coaxial cable	If sheath is cracked, seal with vinyl tape. If immersed with water, install new coaxial cable.
Coaxial & power plug connections	If loosened, reconnect. If corroded, clean contacts.
Battery connection	If corroded, clean power terminals.
Ground terminal	If corroded, clean terminal.

5.2 FUSE REPLACEMENT

To protect the equipment from serious damage, a fuse is provided on the power supply lines. The fuse protect against overvoltage / reverse polarity or internal fault of the equipment. If the fuse has blown, first find out the cause of the trouble before replacing it. A fuse rated for more than 4A should not be used, since it may permanently damage the equipment. Damage due to overfusing is not covered by the warranty.

6.0 GENERAL

Information on most electrical and mechanical parts is included in the parts list. The reference designators are in alphanumeric order.

6.1 ORDERING REPLACEMENT PARTS

Parts orders should be referred to the parts department at:

- Ranger Communications, Inc.
3377 Carmel Mountain Road
San Diego, CA 92121

Tel: 858-259-0287

Fax: 858-259-0437

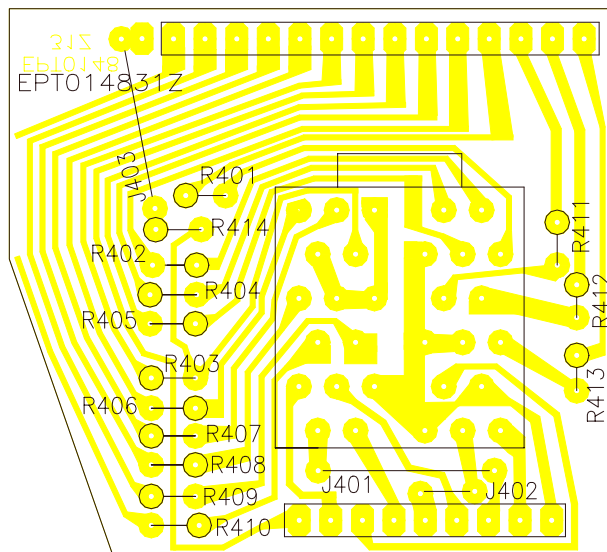

PART LIST:

TR-296GK/DX ROTARY SW. P.C.B

ITEM	REFERENCE NUMBER	RANGER PART NUMBER	DESCRIPTION
1		EPT014831Z	ROTARY SW. P.C.B
2	ROTARY SW PCB	EWRT32059S	ROTARY SW
3	R401-R414	RCU146814Z	680 ohm 1/4W
4	J402	WX01070705	JUMPER WIRE
5	J401	WX01070715	JUMPER WIRE
6	J403	WX01070712	JUMPER WIRE

REMARK:
SOLDER SIDE (BLUE)

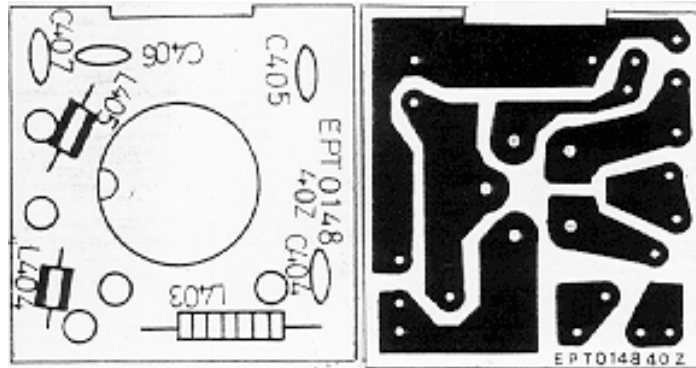

PART LIST:

TR-296GK/DX MIC P.C.B

ITEM	REFERENCE NUMBER	RANGER PART NUMBER	DESCRIPTION
1		EPT014840Z	MIC P.C.B
2	C404-C407	CC0501027L	0.001μF 50V
3	L404,L405	ECBAD18558	BEAD COIL

REMARK:
 LEFT: COMPONENT SIDE
 RIGHT: SOLDER SIDE

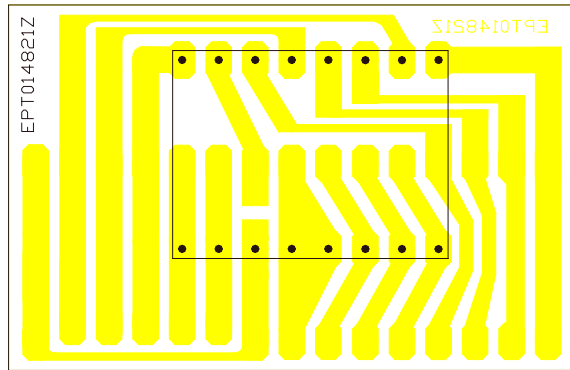

PART LIST:

TR-296GK/DX CH DISPLAY P.C.B

ITEM	REFERENCE NUMBER	RANGER PART NUMBER	DESCRIPTION
1		EPT014821Z	CH DISPLAY P.C.B
2	CH DISPLAY PCB	EX03N40003	LED DISPLAY

REMARK:
 SOLDER SIDE (BLUE)

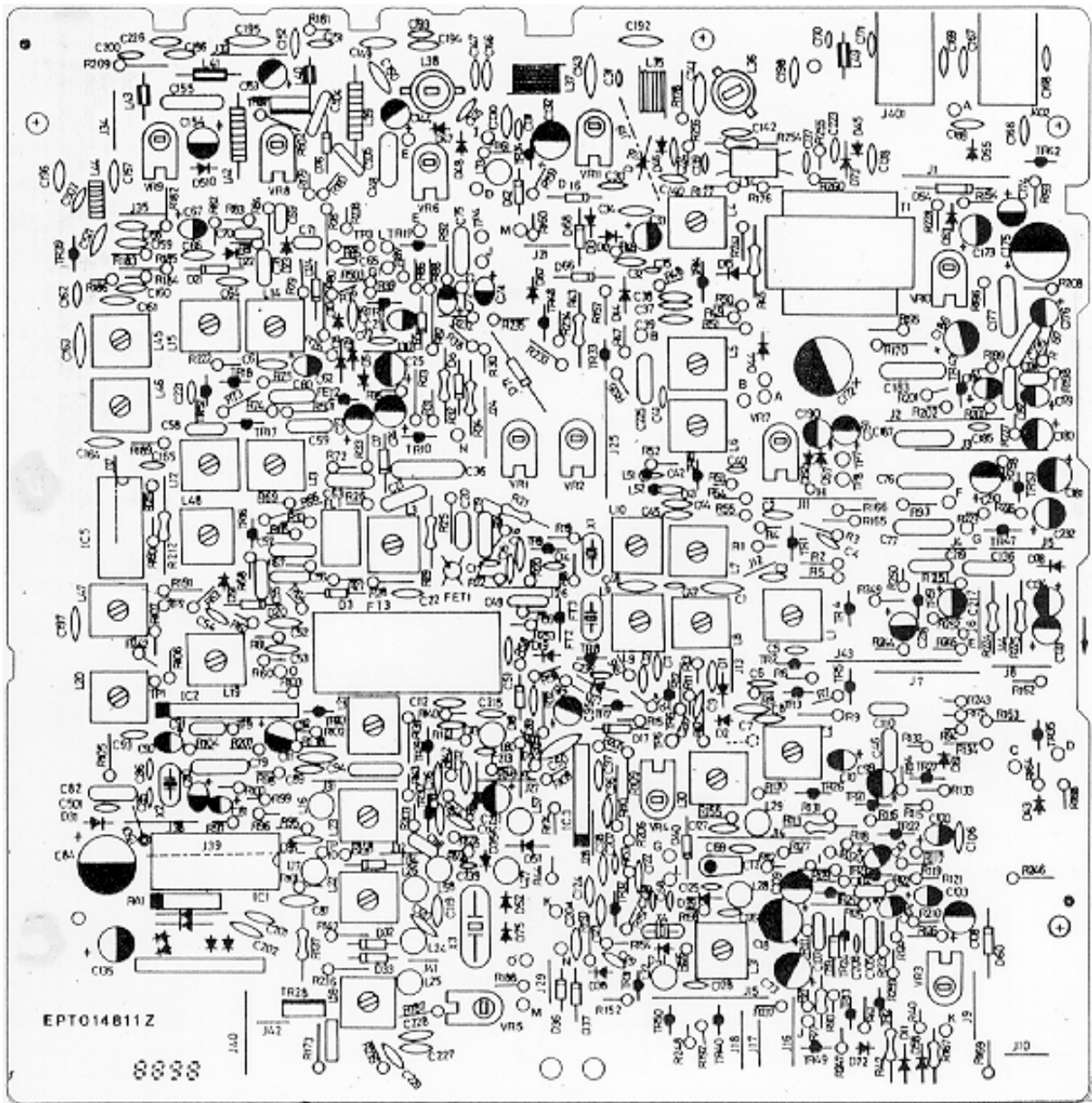

TR-296GK/DX MAIN PCB.

REMARK:
COMPONENT SIDE

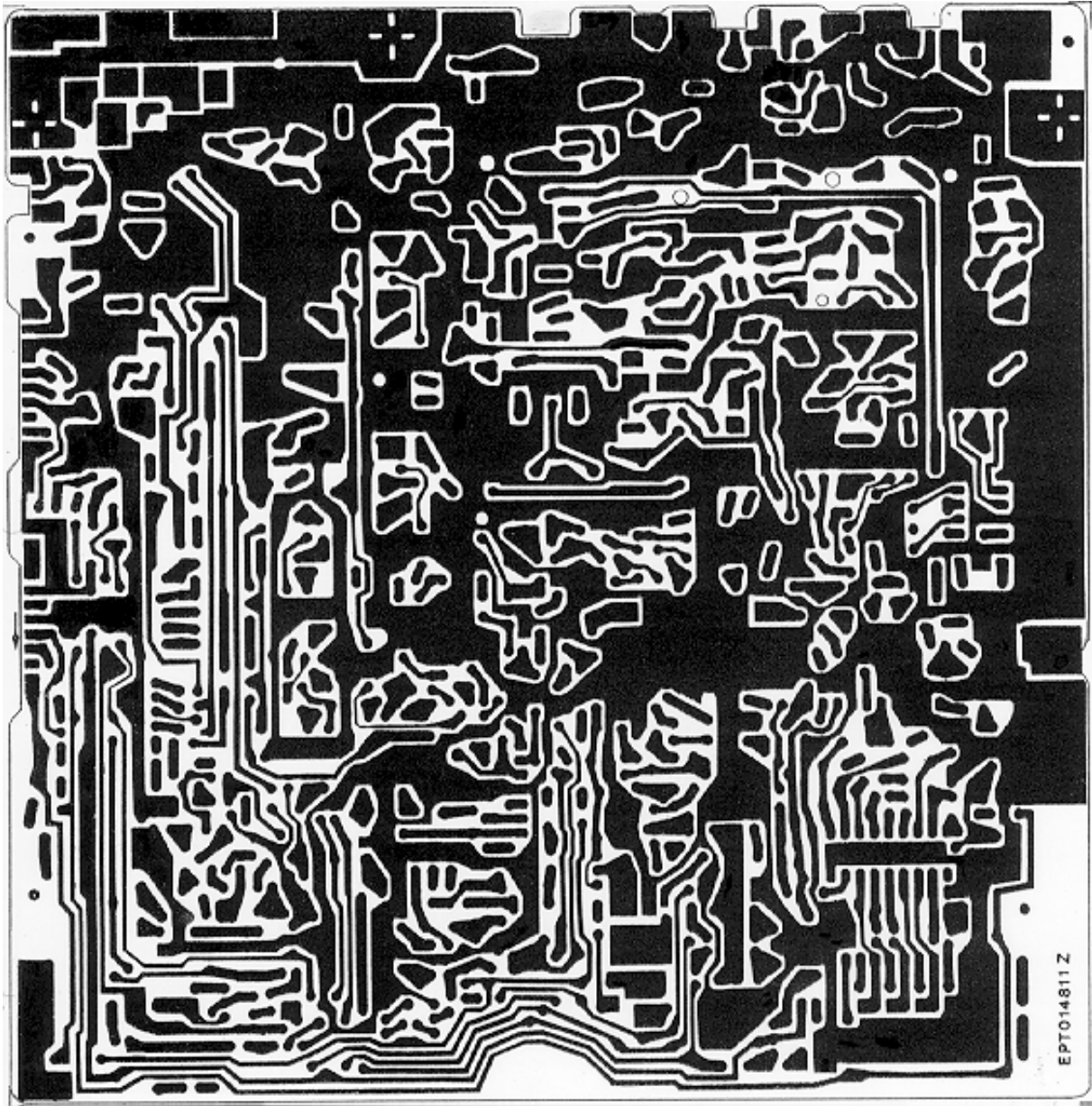

TR-296GK/DX MAIN PCB.

REMARK:
COPPER SIDE

PART LIST

TR-296GK/DX MAIN PCB

REFERENCE NUMBER	RANGER PART NO.	DESCRIPTION			
R208	EPT014813Z	MAIN P.C.B	R43	RCM141824B	1.8K Ω 1/4W
R68	RCU141094Z	1 Ω 1/4W	R34,224	RCM143324B	3.3K Ω 1/4W
R181,183	RCU143394Z	3.3 Ω 1/4W	R32	RCM143924B	3.9K Ω 1/4W
R122	RCU141004Z	10 Ω 1/4W	R113	RCM141034B	10K Ω 1/4W
R62	RCU141504Z	15 Ω 1/4W	R225	RCM141044B	100K Ω 1/4W
R9,76,198	RCU142204Z	22 Ω 1/4W	R107-D53	RCP145604Z	56 Ω 1/4W
R38,51,52,55,105,108,139,186,188,190,241,501,179,189,242.	RCU146804Z	68 Ω 1/4W	R106	RCP141514Z	150 Ω 1/4W
R75,177	RCU141014Z	100 Ω 1/4W	R212	RCP141524Z	1.5K Ω 1/4W
R61	RCU141514Z	150 Ω 1/4W	R207	RCP142724Z	2.7K Ω 1/4W
R25,37,60,70,143,150,209,5	RCU141814Z	180 Ω 1/4W	R101	RCP141034Z	10K Ω 1/4W
R8,15,31,191,233,184,176,3	RCU142214Z	220 Ω 1/4W	R86	RCP144734Z	47K Ω 1/4W
R255	RCU143314Z	330 Ω 1/4W	R178	RCP121034Z	10K Ω 1/4W
R4,57,67,117,256	RCU143914Z	390 Ω 1/4W	R10	RCP141044Z	100K Ω 1/4W
R111,164,228,257	RCU144714Z	470 Ω 1/4W	R193	RCP102214Z	220 Ω 1W
R94,199	RCU145614Z	560 Ω 1/4W	R180	RCP122714Z	270 Ω 1/2W
R59,232	RCU146814Z	680 Ω 1/4W	R169	RCP124704Z	47 Ω 1/2W
R20,24,33,36,48,49,56,87,90,92,104,115,121,138,140,146,211,153,168,170,173,194,195,222,503	RCU148214Z	820 Ω 1/4W	R182	RCP123314Z	330 Ω 1/2W
R30,185,205	RCU141024Z	1K Ω 1/4W	RA1	CCS0573002	C/ARRAY 0.001uF 5P
R26,64,95,74,112,135,165	RCU141224Z	1.2K Ω 1/4W	C145	CC0500301A	3PF 50WV
R27	RCU141524Z	1.5K Ω 1/4W	C130	CC0500101A	1PF 50WV
R41,50,97,102,103,120,141,175,259	RCU141824Z	1.8K Ω 1/4W	C41,47,163	CC0500201A	2PF 50WV
R7,91,144,187,210	RCU142224Z	2.2K Ω 1/4W	C38	CC0500401A	4PF 50WV
R47,109,227	RCU142724Z	2.7K Ω 1/4W	C48,65,116,125	CC0500501A	5PF 50WV
R17,28,58,88,116,134,162,197,201,235,166,1	RCU143924Z	3.9K Ω 1/4W	C98	CC0500802A	8PF 50WV
R46,72,196	RCU143324Z	3.3K Ω 1/4W	C131	CC0501004A	10PF 50WV
R18,40,124	RCU144724Z	4.7K Ω 1/4W	C31	CC0501204A	12PF 50WV
R69,100,200	RCU145624Z	5.6K Ω 1/4W	C68	CC0501504A	15PF 50WV
R44,123,147,148,160,236	RCU146824Z	6.8K Ω 1/4W	C142	CC0502704A	27PF 50WV
R11,12,14,16,19,22,53,65,78,89,93,237,119,126,131,142,145,152,154,157,158,161,203,223,238,239,132,23	RCU148224Z	8.2K Ω 1/4W	C1,128,85	CC0503304A	33PF 50WV
R98,39	RCU141034Z	10K Ω 1/4W	C26,86	CC0503904A	39PF 50WV
R66,79	RCU141234Z	12K Ω 1/4W	C89,147,162,207,502	CC0504704A	47PF 50WV
R2,149,159	RCU141534Z	15K Ω 1/4W	C127,141	CC0508204A	82PF 50WV
R125,128,151,156,163,202,174	RCU141834Z	18K Ω 1/4W	C88	CC0501015A	100PF 50WV
R114	RCU142234Z	22K Ω 1/4W	C9	CC0508204G	82PF 50WV
R73,96,129,99	RCU142734Z	27K Ω 1/4W	C15,17,45	CC0501015G	100P 50WV
R6,118,133,226	RCU143334Z	33K Ω 1/4W	C143	CC0501815G	180PF 50WV
R155	RCU143934Z	39K Ω 1/4W	C123,64,66	CC0502215G	220PF 50WV
R81,84	RCU144734Z	47K Ω 1/4W	C156	CC0502715G	270PF 50WV
R82,83	RCU145634Z	56K Ω 1/4W	C146,150,152	CC0503915G	390PF 50WV
R110	RCU146834Z	68K Ω 1/4W	C117,212	CC0504715G	470PF 50WV
R35,54	RCU141044Z	100K Ω 1/4W	C161	CC0503315G	330PF 50WV
R206	RCU141544Z	150K Ω 1/4W	C213	CC0500602D	6PF 50WV
R13,85	RCU141844Z	180K Ω 1/4W	C149	CC0501015D	100PF 50WV
R234	RCU141544Z	150K Ω 1/4W	C122	CC0501215D	120PF 50WV
R80,127,258	RCU141844Z	180K Ω 1/4W	C158	CC0501815L	180PF 50WV
R167	RCU142744Z	270K Ω 1/4W	C139,137	CC0500591L	0.5PF 50WV
R77	RCU143944Z	390K Ω 1/4W	C236,237	CC0503315L	330PF 50WV
R21	RCM143324A	3.3K Ω 1/4W	C155,192,195,111	CC0251047L	0.1uF 25WV
R29,254	RCM141014B	100 Ω 1/4W	C93,96,97,106,112,113,114,119,120,126,129,164,198,199,40	CC0501037L	0.01uF 50WV
R42,137	RCM141514B	150 Ω 1/4W	C8,11,14,35,37,39,42,5,43,44,170,185,208,201,202	CC0501027L	0.001uF 50WV
R45	RCM141024B	1K Ω 1/4W	C3,4,6,7,16,22,27,50,51,52,53,54,61,83,87,124,196,197,204,215,227,229,2	CC0502237L	0.022uF 50WV
	RCM141524B	1.5K Ω 1/4W	C188	CC0504737L	0.047uF 50WV
			C32,34,140,151,171,157,160,165,169,200,223,224,30,138,167,166,168,159	CC0504725T	0.0047uF 50WV
			C194	CCM254737I	0.047uF 50WV
			C36,77,79,82,177,183,187,136	CM0501045Z	0.1uF 50WV
			C76,78,107,110,118	CM0501035Z	0.01uF 50WV
			C70,71,178	CM0501024Z	0.001uF 50WV
			C21,46,49,55,58,182,63	CM0502235Z	0.022uF 50WV
			C19,56,59,60,75,225,235,91,94	CM0504735Z	0.047uF 50WV
			C69,105	CM0502225Z	0.0022uF 50WV
			C102	CM0504725Z	0.0047uF 50WV

C132	CE0502257H	2.2uF 50V	L5	ECIFT12005	I.F.T
C23,25,108,135,230,231	CE050474Z	0.47uF 50WV	L6	ECIFT12006	I.F.T
C33,134,144,174,191,505	CE0501057Z	1uF 50WV	L7	ECIFT12372	I.F.T
C99,232	CE0502257Z	2.2uF 50WV	L8	ECIFT12373	I.F.T
C24,92,180	CE0504757Z	4.7uF 50WV	L10	ECIFT12374	I.F.T
C181,133,173	CE0251067Z	10uF 25WV	L12	ECIFT12375	I.F.T
C73,109	CE0252267Z	22uF 25WV	L13	ECIFT12376	I.F.T
C95,153,154,176	CE0164767Z	47uF 16WV	L14	ECIFT12377	I.F.T
C18	CE0163377Z	330uF 16WV	L15	ECIFT12378	I.F.T
C84,175	CE0161087Z	1000uF 16WV	L19	ECIFT12380	I.F.T
C172	CE0251087Z	1000uF 25WV	L20	ECIFT12381	I.F.T
C186	CE0162277Z	220uF 16WV	L21	ECIFT12382	I.F.T
C101	CT0161046Z	0.1uF 16WV	L22	ECIFT12383	I.F.T
C10	CT0162246Z	0.22uF 16WV	L23	ECIFT12384	I.F.T
C29,90,104	CT0164746Z	0.47uF 16WV	L30	ECIFT12385	I.F.T
C62,67	CT0161056Z	1uF 16WV	L31	ECIFT12161	I.F.T
C80,81	CT0162256Z	2.2uF 16WV	L45	ECIFT12387	I.F.T
C103	CT0161066Z	10uF 16WV	L46	ECIFT12015	I.F.T
C100,179	CT0162266Z	22uF 16WV	L47	ECIFT12389	I.F.T
C72	CT0163366Z	33uF 16WV	L48	ECIFT12390	I.F.T
C74	CT0164766Z	47uF 16WV	L59	ECIFT12391	I.F.T
J401,J402	EX06N41045	EAR JACK	L35,37	ECSPG18200	SPRING COIL
		3.5mm	L34,41	ECRFZ10053	TDK BRAND
IC3	ENMA00612Z	I.C AN-612	L36	ECRFZ10115	CORE
		7PIN	L44	ECRFZ10116	RF COIL0
IC5	ENSM06130Z	I.C TDA6130			RF COIL
		14PIN	L38	ECRFZ10001	50UH
IC1	ENRG871997	I.C 8719			RF COIL
		18PIN	L39,DCx2	ECCHK16000	0.23UH
IC2	ENNOHIC070	I.C UHIC070			CHOKO COIL
TR14	T2SC01674L	TR2SC1674L	L16,33	ECCHK16002	0.47UH
TR1,2,9,11,15,17,20,29,30,32,34	T2SC01675L	TR 2SC1675L			CHOKO COIL
TR4,5,6,8,10,12,19,21,22,23,24,26,31,33,35,42,43,52,53	T2SC00945P	TR 2SC945P	L17,27,28,29,32,57,58,60	ECCHK16003	100UH
TR7,13,25,27,47,48	T2SA00733P	TR 2SA733P	L24,25,26	ECCHK16089	CHOKO COIL
TR3,18	T2SC01906Z	TR2SC1906			470UH
TR28,37	T2SC01846Z	TR 2SC1846			CHOKO COIL
TR39	T2SC02538Z	TR 2SC2538			220UH
TR16	T2SC01675K	TR 2SC1675K	L42	ECCHK16158	CHOKO COIL
FET1	F3SK00085B	F.E.T	L51,52	ECBAD18504	1UH
		3SK85B	140,43,49	ECBAD18506	CHOKO COIL
FET3	F2SK00192R	F.E.T			5.6UH
		2SK192A-GR	CT2	CV050200AZ	BEAD COIL
FET2	F2SK00192L	F.E.T			3.5x6x1.2
		2SK192ABL	VR3,7,9,8	RE10200003	BEAD COIL
X2	EYCAB10240	CRYSTAL	VR1,2,5	RE30200019	3.5x6x1.2
		10.240MHZ	VR10	RE50200006	TRIMMER/C
X4	EYCAM07800	CRYSTAL	VR4,11	RE10300009	20PF 5Q
		7.800MHZ	VR6	RE10400020	1K Ω L
X1	EYCAE07345	CRYSTAL	T1	ETP2820101	3K Ω L
		7.3455MHZ			5K Ω
X3	EYCAL11325	CRYSTAL			10K Ω L
		11.325MHZ	C148-TP8	WK0519017F	100K Ω L
FL1	EFCFW455HT	C/FILTER	D510-TP7	WK0719017F	TRANSFORMER
		CFW-455HT	J41	WX01070705	EI-28
FT2	EFX2078002	C/FILTER	J12,J42,L501	WX01070706	SHIELD WIRE
		7.800MHZ	J10,13,17,21,28,29,32,35,44	WX01070708	SHIELD WIRE
FT3	EFX27Z22C9	C/FILTER	J4,6,8,18,27,34	WX01070710	JUMPER WIRE
		7.800MHZ	J24	WX01070712	JUMPER WIRE
D44	EDZD05180Z	ZENER DIODE	J30	WX01070709	JUMPER WIRE
		UZ-18V 0.5W	J5,9,16,26,33,38	WX01070713	JUMPER WIRE
D3,5,6,7,8,9,11,14,15,16,17,18,19,20,23,24,31,32,33,34,36,37,38,39,40,41,42,43,47,48,51,58,59,60,61,62,63,65,66,67,68,76,77,R107-TP2	ED1N04148Z	DIODE	J31,37,40	WX01070715	JUMPER WIRE
D2,10,21,22,45,46,54,71,1,73,79	ED1N00060P	DIODE 1N4148	J1,7	WX01070718	JUMPER WIRE
D12,13	EDMA00859Z	DIODE 1N4148	J2,11,15,19,25	WX01070720	JUMPER WIRE
D55,78	ED1N04003Z	DIODE MA859	J14	WX01070722	JUMPER WIRE
		DIODE	J3,43	WX01070723	JUMPER WIRE
D52,75	EDMA00027W	DIODE 1N4003	J39	WX01070727	JUMPER WIRE
		DIODE	B-B	WL0408009Z	LEAD WIRE
L1	ECIFT12366	MA27W-A	R130-VR7(H)	WL1212009Z	LEAD WIRE
L2	ECIFT12367	DIODE	N-N	WL0316009Z	LEAD WIRE
L3	ECIFT12248	DIODE	K-K	WL0517009Z	LEAD WIRE
L4	ECIFT12369	DIODE	C184-A	WL0814009Z	LEAD WIRE
		MA27W-A	A-A	WL0916009Z	LEAD WIRE
			C-D44	WL0017009Z	LEAD WIRE
			E-C148	WL0620009Z	LEAD WIRE
			M-M	WL0120009Z	LEAD WIRE
			I-I	WL0421009Z	LEAD WIRE
			O-O	WL0217009Z	LEAD WIRE

D-D	WL0125009Z	LEAD WIRE
J-J	WL0725009Z	LEAD WIRE
MAIN	WP0818005Z	SHIELD WIRE
MAIN	WP0923005Z	SHIELD WIRE
TP7,8	GZZZ50145Z	PIN
D35,69(COPPER SIDE)	EDHU00200Y	DIODE(SMD)
R502(COPPER SIDE)	RCP146804Z	68 Ω 1/4W
MAIN(COPPER SIDE)	WP0812005Z	SHIELD WIRE
FREQ. COUNTER	EX07N48793	WIRE CONN/H
DCx1	CC0501027L	0.001uF 50WV
DCx1	CC0501037L	0.01uF 50WV
DCx1	CC0502237L	0.022uF 50WV
D49	EDNV00001Z	DIODE NVS-01
D50	EDNV00002Z	DIODE NVS-02
IC4	ENFU03756Z	IC MB3756
IC6	ENTA07222A	IC TA7222AP
TR36	T2SC01969C	TR 2SC1969C
TR38	T2SC02166C	TR 2SC2166C
TR41	T2SD01135Z	TR 2SD1135

DATE	REV	BY	CHK

MANUFACTURED BY: ELECTRONIC COMPONENTS, INC.
 MODEL: TP-8800/DX
 TITLE: SCHEMATIC DIAGRAM
 PARTS LIST: 6724/8800
 DATE: 1974

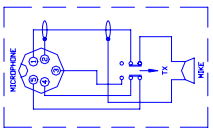
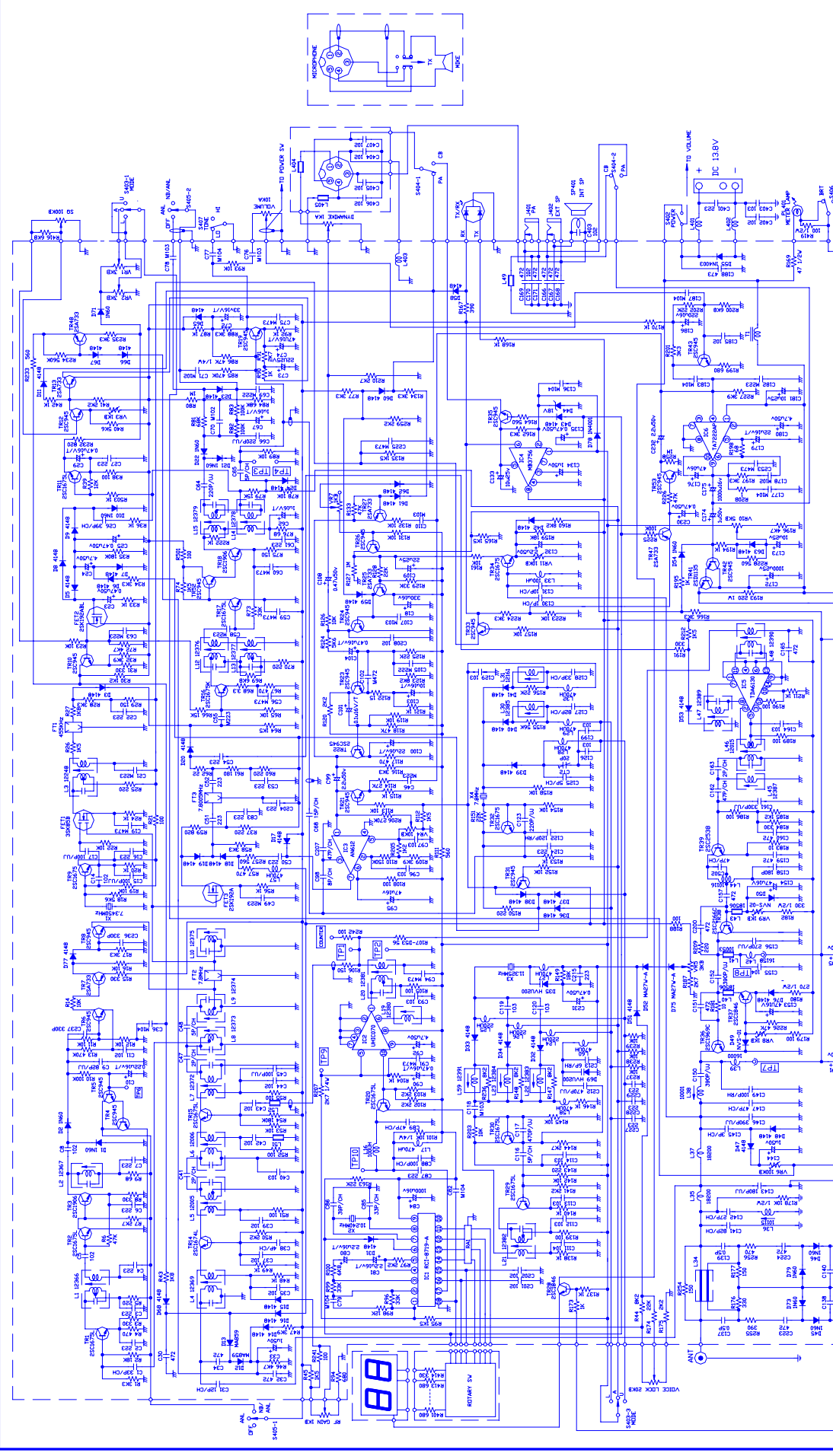

- RESISTORS**
- R1 100K
 - R2 100K
 - R3 100K
 - R4 100K
 - R5 100K
 - R6 100K
 - R7 100K
 - R8 100K
 - R9 100K
 - R10 100K
 - R11 100K
 - R12 100K
 - R13 100K
 - R14 100K
 - R15 100K
 - R16 100K
 - R17 100K
 - R18 100K
 - R19 100K
 - R20 100K
 - R21 100K
 - R22 100K
 - R23 100K
 - R24 100K
 - R25 100K
 - R26 100K
 - R27 100K
 - R28 100K
 - R29 100K
 - R30 100K
 - R31 100K
 - R32 100K
 - R33 100K
 - R34 100K
 - R35 100K
 - R36 100K
 - R37 100K
 - R38 100K
 - R39 100K
 - R40 100K
 - R41 100K
 - R42 100K
 - R43 100K
 - R44 100K
 - R45 100K
 - R46 100K
 - R47 100K
 - R48 100K
 - R49 100K
 - R50 100K
 - R51 100K
 - R52 100K
 - R53 100K
 - R54 100K
 - R55 100K
 - R56 100K
 - R57 100K
 - R58 100K
 - R59 100K
 - R60 100K
 - R61 100K
 - R62 100K
 - R63 100K
 - R64 100K
 - R65 100K
 - R66 100K
 - R67 100K
 - R68 100K
 - R69 100K
 - R70 100K
 - R71 100K
 - R72 100K
 - R73 100K
 - R74 100K
 - R75 100K
 - R76 100K
 - R77 100K
 - R78 100K
 - R79 100K
 - R80 100K
 - R81 100K
 - R82 100K
 - R83 100K
 - R84 100K
 - R85 100K
 - R86 100K
 - R87 100K
 - R88 100K
 - R89 100K
 - R90 100K
 - R91 100K
 - R92 100K
 - R93 100K
 - R94 100K
 - R95 100K
 - R96 100K
 - R97 100K
 - R98 100K
 - R99 100K
 - R100 100K
- CAPACITORS**
- C1 100P
 - C2 100P
 - C3 100P
 - C4 100P
 - C5 100P
 - C6 100P
 - C7 100P
 - C8 100P
 - C9 100P
 - C10 100P
 - C11 100P
 - C12 100P
 - C13 100P
 - C14 100P
 - C15 100P
 - C16 100P
 - C17 100P
 - C18 100P
 - C19 100P
 - C20 100P
 - C21 100P
 - C22 100P
 - C23 100P
 - C24 100P
 - C25 100P
 - C26 100P
 - C27 100P
 - C28 100P
 - C29 100P
 - C30 100P
 - C31 100P
 - C32 100P
 - C33 100P
 - C34 100P
 - C35 100P
 - C36 100P
 - C37 100P
 - C38 100P
 - C39 100P
 - C40 100P
 - C41 100P
 - C42 100P
 - C43 100P
 - C44 100P
 - C45 100P
 - C46 100P
 - C47 100P
 - C48 100P
 - C49 100P
 - C50 100P
 - C51 100P
 - C52 100P
 - C53 100P
 - C54 100P
 - C55 100P
 - C56 100P
 - C57 100P
 - C58 100P
 - C59 100P
 - C60 100P
 - C61 100P
 - C62 100P
 - C63 100P
 - C64 100P
 - C65 100P
 - C66 100P
 - C67 100P
 - C68 100P
 - C69 100P
 - C70 100P
 - C71 100P
 - C72 100P
 - C73 100P
 - C74 100P
 - C75 100P
 - C76 100P
 - C77 100P
 - C78 100P
 - C79 100P
 - C80 100P
 - C81 100P
 - C82 100P
 - C83 100P
 - C84 100P
 - C85 100P
 - C86 100P
 - C87 100P
 - C88 100P
 - C89 100P
 - C90 100P
 - C91 100P
 - C92 100P
 - C93 100P
 - C94 100P
 - C95 100P
 - C96 100P
 - C97 100P
 - C98 100P
 - C99 100P
 - C100 100P

NOTE : INDICATION FOR MODELS ARE LIST AS BELOW :

1. TR-2966K (*)
2. TR-296DXB (**)
3. TR-296DXC (***)

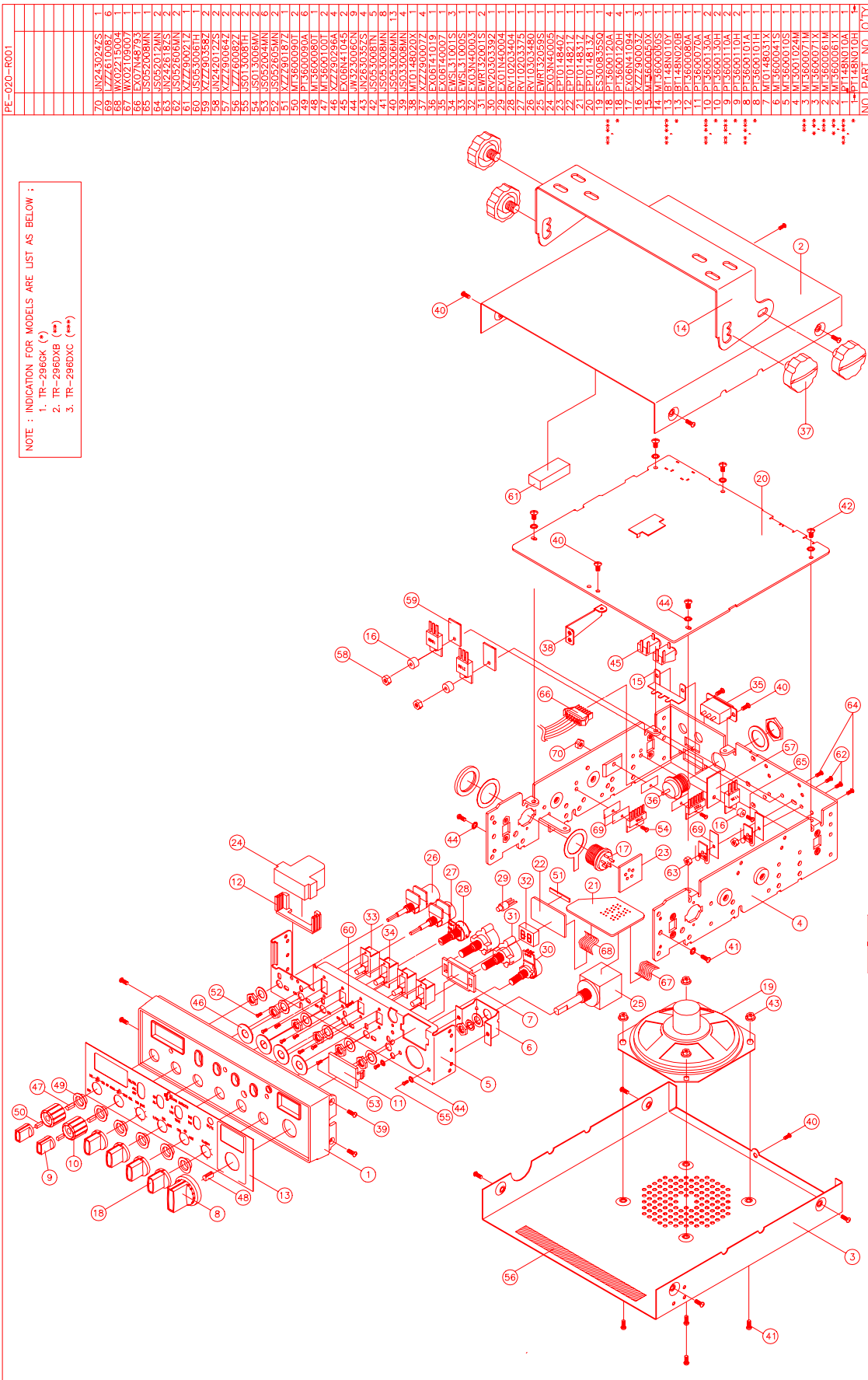

MODEL	SCALE	CHECKED	DRAWN	mm	units	APPROVED	DATE	TITLE	FILE NAME	PAGE NO.	TOTAL
MODEL 1 MODEL 2							7 OCT. 1999	EXPLODE DRAWING	296_EXP	1 / 1	A2

REMARKS:

COMMUNICATIONS (M) Smt. BHD.

NO PART NO. QTY

70	IN2430ZAZS	1
69	IN2430ZAZS	1
68	WX0221500A	0
67	WX02109007	1
66	EX07M48793	1
65	IS052606MN	2
64	IS052606MN	2
63	IN2426187S	2
62	IS052606MN	2
61	KZZ900217	2
60	KZZ900217	2
59	KZZ900587	2
58	IN2420122S	2
57	KZZ900642	2
56	KZZ900877	2
55	IS013006MV	2
54	IS052604MN	6
53	IS052605MN	2
52	IS052605MN	2
51	KZZ901872	2
50	IS052606MN	2
49	PT360090A	6
48	PT360090A	6
47	PT360100T	2
46	KZZ90199A	2
45	KZZ90199A	2
44	HW323006GN	8
43	IN2630357S	4
42	IS0530081N	6
41	IS0530081N	6
40	IS0530081N	6
39	IS033008MN	4
38	MT0148020X	1
37	KZZ900072	4
36	EX06140019	4
35	EX06140019	4
34	EW5L31001S	3
33	EW5L31001S	3
32	EX03M40003	1
31	EX03M40003	1
30	RV0303392	2
29	EX01M40004	1
28	RV10203404	1
27	RV10203375	1
26	RV10203375	1
25	EMRT32059S	2
24	EX03M40005	1
23	EP10148402	1
22	EP10148417	1
21	EP10148417	1
20	EP10148132	1
19	ES3008355Q	1
18	PT3600120A	4
17	PT3600120A	4
16	PT3600120A	4
15	WZZ900032	3
14	WZZ900032	3
13	BT48N020B	1
12	BT48N020B	1
11	PT3600070A	1
10	PT3600130A	2
9	PT3600130A	2
8	PT360010A	2
7	PT360010A	2
6	PT3600041S	1
5	PT3600041S	1
4	PT3600041S	1
3	PT3600041S	1
2	PT3600041S	1
1	PT3600041S	1



AT0296040A

© COPYRIGHT 1999, RANGER COMMUNICATIONS INC.