

MIDLAND®

6001
FCC DATA: 79-006

SSB/AM 40-CHANNEL
MOBILE TRANSCEIVER

MANUAL NO. 79-006000
DATE: MAY 3, 1979



Midland 6001 Mobile CB Transceiver: Technical Specifications.

General Construction.

1. Three-pin polarized jack for DC power.
2. Four-pin screw connector for microphone
3. No mechanical relays. All switching is solid state using diodes and transistors, for high reliability.
4. Transmitter output stage is protected from mismatch, no-load or short-circuit conditions
5. Input power is suitably filtered and bypassed to deter alternator "whine" on transmit or receive

Electrical Specifications.

General:

Voltage 13.8 V. Positive, Negative Ground
Operating Range 10 V to 16 V
Frequency Stability $\pm 0.005\%$
Temperature Range -30° to $+50^{\circ}$ C
(Per FCC Part 15)
Humidity 5-90%
Vibration EIA Standard RS-424
Shock EIA Standard RS-424

Receiver (AM):

Sensitivity
Less than 0.7 μ v for 10 dB SN+N to N
Automatic Gain Control Figure of Merit
80 dB
Audio Squelch Sensitivity
Threshold Less than 10 dB SN+N to N
Tight: 100 μ v minimum, 500 μ v
maximum

Adjacent Channel Selectivity and Desensitization

60 dB (Two-generator method)
Spurious Response Attenuation
60 dB (excluding image at 50 dB)

Audio Power Output
3 W @ 10% distortion (load impedance
8 ohms resistive)

Audio Frequency Response (1 KHz, 0 dB
reference)

300 Hz @ -6 dB
1000 Hz @ 0 dB
3000 Hz @ -6 dB

Hum and Noise, Squelched

-45 dB

Noise Limiting
Provided with Switchable ANL

S Meter Sensitivity at S-9
100 μ v

RF Gain Range

30 dB

Antenna Input Impedance

50 ohms, unbalanced

Transmitter (AM):

Carrier Power, No Modulation
4 W maximum, 3.6 minimum
Conducted Spurious Emissions
-65 dB

Radiated Spurious Emissions
(Complies with FCC Part 95)

Audio Frequency Harmonic Distortion
10% maximum @ 80%

Audio Frequency Response (1 KHz, 0 dB reference)

300 Hz @ -6 dB
1000 Hz @ 0 dB
3000 Hz @ -6 dB

6 dB/octave falling above 3000 Hz

Hum and Noise

-40 dB

Output Impedance

50 ohms, unbalanced

Output Protection

Withstands for 5 minutes all VSWR
around Smith Chart at 20:1 without
damage or failure

Output Stability

Does not exceed FCC Limits For
Spurious Emissions when operated
into a mismatch load with 5:1 VSWR at
any point on the Smith Chart

Controls: Off-AF gain control, Squelch
control, RF gain control, Microphone
Gain control, CB-PA switch, Hi/Lo
Tone switch, ANL-Off switch,
S/RF-PWR Meter, Green color
Numerical LED Channel indicator,
Rotary Analog-Numerical Channel
selector

Jacks and Connections: 4-pin screw-type
Microphone Connector, 50-ohm
antenna, 8-ohm external speaker, PA
speaker

Accessories Included: 500-ohm push-to-talk
microphone with coil cord and screw-
on, 4-pin connector, Microphone clip,
Mounting bracket and hardware
Owners manual, FCC forms 505,
555-B, Part 95

MIDLAND®

Distribution and Service Center
1690 North Topping Street
Kansas City, Missouri 64120
Telephone: (913) 384-4200

Midland Precision Series 6001 Mobile CB Operating Controls.



How to install your Midland mobile CB.

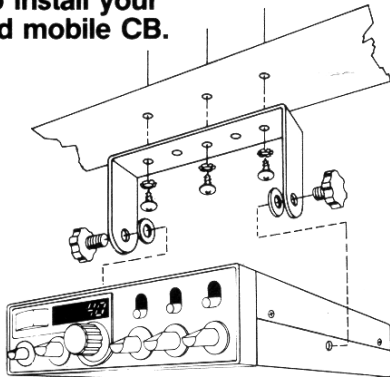

This transceiver may be installed in any 12-volt negative or positive ground-system car or truck. Most current U.S. and foreign vehicles use a negative system, but some older models and some newer large trucks may have a positive ground.

Check the requirements for your vehicle before you begin installation.

Generally, you have a negative-ground system if the minus (-) battery terminal is connected to the motor block. Contact your dealer in the event you are unable to determine your vehicle's polarity system.

Installation and operating accessories furnished with your Midland Mobile CB:

1. "Take-it-with-you" adjustable mounting bracket system.
2. Microphone bracket system.
3. All main-unit and microphone mounting hardware needed for normal installation.
4. DC power cord with plug.
5. Plug-in microphone with coil cord.

6. FCC Form 505.
7. FCC Part 95, Subpart D.
8. FCC Form 555-B.
9. Owner's Manual.
10. Customer Registration Card.

Where to locate your CB transceiver.

Your new Midland CB is designed to be installed under the dash of your vehicle.

Safety and convenience are the primary considerations in deciding exactly where to locate your radio.

The transceiver is designed with most-often-used controls nearest the driver. Still, make sure other controls are easily reached.

Caution: Be sure that the unit is located so that it does not interfere with the driver or impair access to any controls. Connecting cables must be routed and secured in such a manner as not to interfere with the operation of the brake, accelerator or other controls. Interference from either the unit or connecting cables may contribute to the loss of control of the vehicle.

Mechanical mounting.

Step 1: Heeding the preceding caution, use the mounting bracket as a template for marking the location of screwholes under your dash. Use an awl, nail or other pointed object to mark the metal.

Step 2: Drill a 1/8" hole for each screwhole in the mounting bracket. Attach the bracket to the dash with the 3/8" Phillips machine screws provided.

Extreme caution should be exercised

when drilling into dash to avoid damage to under-dash electronic ignition, cruise control, instrument and/or accessory wiring.

Step 3: Attach removable 3-pin, plug-in DC cord to 3-pin polarized DC jack on the rear of the transceiver.

Step 4: Locate and secure the radio into the mounting bracket, allowing working space for later power connections.

Power wiring.

Step 1: If you have not determined whether your vehicle has a negative or positive ground, do so now.

Then disconnect the leads from the battery to prevent short circuits that can occur during wiring.

Step 2: With negative ground, connect the red wire — the one with in-line fuse holder — to either the (a) fuse block, (b) cigarette lighter or (c) directly to the positive post on your battery.

(Usually, the fuse block is the most convenient connecting point. It is also possible to connect to the Accessory terminal on the fuse block

or ignition switch, so that your CB automatically goes off when the ignition goes off, preventing accidental battery drainage.)

Then tightly connect the black wire directly to the vehicle's metal frame.

With a positive ground, reverse the wires, connecting the red/fuse-holder wire to the frame, the black wire to your DC power source. A light or meter can be a good aid in locating a suitable power source and ground.

In either case, a good, direct metal-to-metal ground is essential for optimum performance.

CAR'S MOTOR BLOCK OR FIRE WALL GROUND

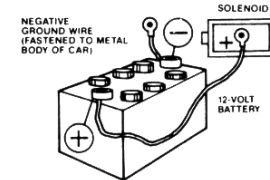

EXAMPLE OF NEG GROUND 12-V DC CAR BATT CONNECTION ILLUSTRATION MOST CARS & TRUCKS ARE THIS TYPE

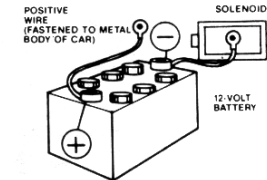

EXAMPLE OF POS GROUND 12-V DC CAR BATT CONNECTION ILLUSTRATION FEW 18-WHEELERS & OLDER CARS

Mounting the main unit.

Step 1: Loosen the retaining knobs on each side of the mounting bracket to give enough space for the unit to slide between the two bracket arms.

Step 2: Position the main unit between the bracket arms in line with the retaining knobs. Set the height and angle for optimum operating comfort and accessibility.

Step 3: Tighten the retaining knobs.

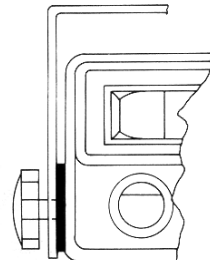
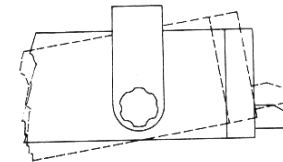

Installation of microphone hanger.

Mounting holes are provided on the side of the transceiver for the microphone hanger bracket. Alternately, the bracket can be attached to the vehicle dash.

Connecting optional remote speaker.

Locate the "EXT" jack on the main unit rear panel. Firmly insert and seat the speaker wire plug into the jack.

When connected, the external speaker will override and "blank out" the in-unit speaker standard with your Midland Mobile CB.

Connecting optional Public Address speaker.

Locate the "PA" jack on the main unit back panel. Firmly insert and seat the speaker wire plug into the jack.

Directions for mounting the optional Public Address speaker are included, along with mounting hardware, with the speaker.

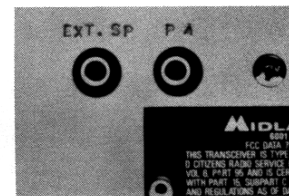

Operating controls, connectors: Their functions and uses.

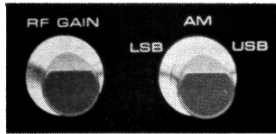
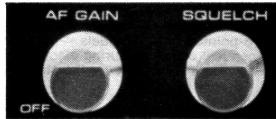
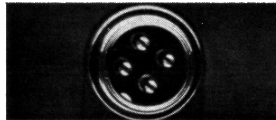

Starting at the upper left (driver's side) corner of your Midland 6001 and moving counter-clockwise:

S/RF Power Meter. This new high-visibility, black-on-light green meter is used two ways. (1) When receiving, it gives the relative strength of incoming signals. (2) When transmitting, it shows RF (Radio Frequency) power output.

4-pin/Screw-type Microphone Connector. Securely links your microphone to the main unit during use, yet allows quick disconnection when out of service.

Off/AF Gain Control. Turns your CB on and adjusts the Audio Frequency (volume) level for comfortable reception.

Squelch Control. Turned clockwise, it quiets the receiver when signals are not being received and allows a quiet standby operation.

The Squelch Control functions only in the receive mode and does not affect receiver volume when signals are being received.

To adjust, when no signals are present, rotate the Squelch Control clockwise until the receiver is quieted. Incoming signals will automatically release the squelch action.

Careful adjustment is necessary as a setting too far clockwise will not allow weaker signals to release the squelch action.

LED Digital Channel Display. Illuminated in easy-to-read green, it displays the channel selected by use of the analog-numbered selector dial just below.

RF (Radio Frequency) Gain Control. Controls the reception sensitivity (range) of your CB. To decrease RF gain — to reduce interference, for example, in congested urban areas — turn the knob counter-clockwise; to increase turn clockwise. The RF Gain Control affects reception only. It will not affect transmitter output power.

LSB-AM-USB Mode Selector Switch. Selects the mode of transmission and reception. Either the upper sideband or lower sideband of a channel can be selected, or conventional AM operation.

Clarifier Control. "Fine-tunes" signals received on either the upper or lower sideband.

CB/PA Switch. An optional PA speaker may be attached to your transceiver through the PA output jack on the back panel. This allows you to communicate with pedestrians or other vehicles through your CB microphone. The CB/PA switch changes your CB speaker system from a CB function, using the internal main-unit speaker, to a Public Address function using an external speaker.

NB/ANL Switch. In the NB (Noise Blanker) setting, it reduces electrical impulse noises, such as those caused by engine ignition systems. In the ANL (Automatic Noise Limiter) setting, it reduces atmospheric noise and other electrical interference. The "Off" setting is used when neither problem exists.

Hi-Lo Tone Control. Controls the tonal quality of received signals in accordance with the user's preference.

Dual red/green TX/RX Indicator. When red, it indicates the unit is transmitting and acts as a warning when the microphone push-to-talk bar is accidentally keyed. When green, it indicates your transceiver is in the "receive" mode.

External Speaker Jack. Allows you to attach an external speaker that will override the unit's internal speaker. Connection is made through the External Speaker Jack on the back panel.

PA Jack. An optional PA speaker may be attached to your transceiver through the PA output jack on the back panel. This allows you to communicate with pedestrians or other vehicles through your CB microphone.

Microphone Push-to-Talk Bar. Simply push this bar to transmit; release when receiving.

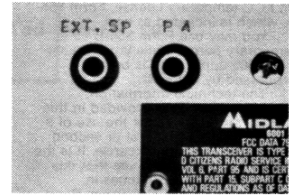
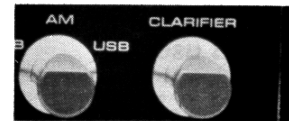

Midland 6001: Operating Instructions.

Having properly installed and wired your CB and antenna, you are now ready for the eight steps designed to get you into effective, satisfactory operation:

Step 1: Insert the plug from the microphone into the microphone jack on the face panel, and screw on securely.

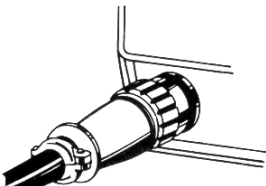

Step 2: Make sure your antenna is securely connected to the antenna connector.

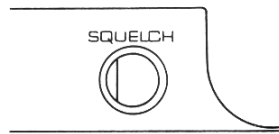

Step 3: Make sure the Squelch Control is in the 9:00 position.



Step 4: Make sure the RF Gain Control is fully clockwise.

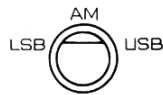

Step 5: Select the desired mode of operation, USB, AM or LSB, using the selector switch.



Step 6: Turn the power on and adjust the Audio Frequency (AF) Gain Control for a satisfactory sound level.

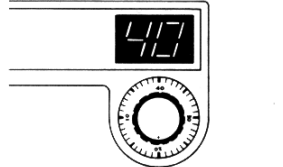

Step 7: Select your desired channel by turning the Channel Selector dial below the LED digital indicator.



Step 8: To transmit, press the push-to-talk bar on the microphone. To receive, release the bar.

Antennas: How to select, position, install and tune the right one for you.

Basically, you have two types of mobile CB antennas — full-length whip and loaded whip — and a variety of types of mounts (depending on where you locate your antenna) to choose from.

Midland markets a broad line of high-performance antennas. The dealer who sold you your Midland CB can advise which type is best for you.

Where you locate your antenna does make a difference.

Some general rules for antenna location that can aid CB performance:

1. Put your mount as high on the vehicle as possible.
2. The higher the proportion of antenna length that is above the roof, the better.
3. If possible, mount the antenna in the center of whatever surface you choose.
4. Keep antenna cables away from noise sources, such as the ignition system, gauges, etc.
5. Make sure you have a solid metal-to-metal ground.
6. Exercise care to prevent cable damage.

Essentially, you have five location choices: the roof, gutter, rear deck, front cowl or rear bumper.

Where you decide to locate your antenna will determine the type of antenna you install. Again, consult your Midland CB Dealer for advice and guidance, and measure your needs against the attributes of the various Midland antenna models he carries.

Antenna installation.

Follow the manufacturer's installation instructions carefully.

Warning: Never operate your CB radio without attaching an antenna or with a broken antenna cable. This can result in damage to transmitter circuitry.

Tuning your antenna.

Some antennas are factory tuned. However, performance can usually be improved by slightly lengthening or shortening its length, using a Standing Wave Ratio (SWR) meter. For the exact procedures to be used, refer to the antenna manufacturer's installation manual.

You can buy an SWR meter separately or have your antenna checked by your Midland CB Dealer's service department.

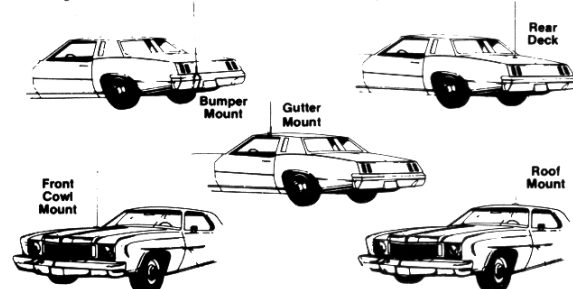

FCC requirements for CB users.

Your new Midland Mobile CB is a combination receiver/transmitter (transceiver) designed and built for licensed Class D operation on any of the 40 frequencies designated for citizens band use by the Federal Communications Commission.

You are required to have or have ordered a current copy of Part 95, Subpart D, of the FCC rules and regulations (a current copy as of the date of manufacture is included with your new CB) prior to operation of this unit.

You are also required to complete FCC Form 505 (also included with your CB) and submit it to the **FCC, Gettysburg, PA 17326** in order to obtain your license to operate this unit.

(Disregard the above paragraph if you have a current CB license less than 5 years old.)

FCC regulations will be violated if you transmit with this unit without complying with procedures explained on FCC temporary license, Form 555-B, which is included as well. You may use Form 555-B as a temporary permit while your regular Form 505 application is being processed by the FCC.

The technical information, diagrams and charts provided in this manual are supplied for the use of a qualified holder of a first or second class radio-telephone license. It is the user's responsibility to see that this unit is operating at all times in accordance with FCC Citizens Band Radio Service regulations.

If you install your own transceiver, do not attempt to make any transmitter or receiver tuning adjustments. These adjustments are prohibited by the FCC unless you hold a first or second class radio-telephone license. A Citizens Band or Amateur license is not sufficient.

When service is performed by an authorized and licensed person, care must be taken that only authorized replacement parts are used in order not to void the type acceptance or certification of this model.

Midland International Corporation hereby certifies that this unit has been designed, manufactured, FCC type accepted and certified in accordance with Part 95 and Part 15, Subpart C, of the current FCC rules and regulations as of the date of manufacture.

General CB information.

In 1958, The Federal Communications Commission approved the use of 23 channels by duly licensed Citizens Band radio operators. The authorization was expanded to 40 channels in 1977.

A simple, basic means of communication, CB requires no more skill or knowledge than the operation of a standard AM or FM receiver.

Still, there are certain facts, procedures and "rules of the road" you'll need to know in order to make the most of your CB experience.

Make it "short and sweet." When using your CB, get on and off the air as quickly as possible. Never use profanity — which is against the law and subject to heavy penalties. Follow the FCC rules outlined in Part 95.

Use Channel 9 in emergencies only. Emergency channel 9 is designated for this purpose and this purpose alone.

The FCC has given public safety agencies various "call signs" including "0911" numbers, coinciding with the "911" phone numbers these agencies use in telephone communications.

The call signs for state-level agencies use 3 letters and 4 numbers, with the second and third letters being the official Post Office state abbreviation, e.g., "KS" for "Kansas."

Why and how to use the "10 Code." Developed over the years by official agencies in order to save time and provide precise, clear messages, the "10-Code" has become a popular tool for CBers.

The table below lists some of the more common codes and their meanings.

Code	Meaning	10-35	Confidential information.
10-1	Receiving poorly.	10-36	Correct time is.
10-2	Receiving well.	10-37	Wrecker needed at.
10-3	Stop transmitting.	10-38	Ambulance needed at.
10-4	OK, message received.	10-39	Your message delivered.
10-5	Relay message.	10-41	Please turn to Channel.
10-6	Busy, stand by.	10-42	Traffic accident at.
10-7	Out of service; leaving the air.	10-43	Traffic tie-up at.
10-8	In service, subject to call.	10-44	I have a message for you
10-9	Repeat message.	10-45	All units within range report.
10-10	Transmission completed, standing by.	10-50	Break channel!
10-11	Talking too fast.	10-60	What is next message number?
10-12	Visitors present.	10-62	Unable to copy; use phone.
10-13	Advise weather/road conditions.	10-63	Network directed to.
10-16	Make pickup at.	10-64	Network clear.
10-17	Urgent business.	10-65	Awaiting your next message/assignment.
10-18	Anything for us?	10-67	All units comply.
10-19	Nothing for you; return to base.	10-70	Fire at.
10-20	My location is.	10-71	Proceed with transmission in sequence.
10-21	Call by telephone.	10-77	Negative contact.
10-22	Report in person to.	10-81	Reserve hotel room at.
10-23	Stand by.	10-82	Reserve room for.
10-24	Completed last assignment.	10-84	My telephone number is.
10-25	Can you contact?	10-85	My address is.
10-26	Disregard last information.	10-91	Talk closer to mike.
10-27	I am moving to Channel.	10-93	Check my frequency on this channel.
10-28	Identify your station.	10-94	Please give me a long count.
10-29	Time is up for contact.	10-99	Mission completed; all units secure.
10-30	Does not conform to FCC rules.	10-200	Police needed at.
10-32	I will give you a radio check.		
10-33	Emergency traffic.		
10-34	Trouble at this station.		

Musts and mustn'ts of CB usage.	You mustn't blast others off the air by overpowering them with illegal transmitter power or illegally high antennas.
You must identify your official licensed call sign at the finish of every conversation.	You mustn't use CB to promote illegal activities.
You mustn't carry on a conversation with another station for more than 5 minutes at a time without taking a 1-minute break, to give others use of the channel.	You mustn't use profanity.
	You mustn't play music on your CB.
	You mustn't use your CB to sell merchandise or commercial services.

Factors affecting effective CB range.

Essentially, they're the same influences that optimize or limit AM, FM and other kinds of performance in moving vehicles:

Terrain: Hills and valleys naturally interrupt and shorten CB signals.

Weather: You can expect that CB range will be reduced — perhaps drastically — in times of atmospheric disturbance, such as in a thunderstorm or heavy snow. Sunspots, too, are known to adversely affect CB performance.

Obstructions. Inside a tunnel, covered parking garage or viaduct, CB transmitting/receiving capability may be cut off altogether.

In short, you can expect to maintain maximum transmitting/receiving performance in flat, open country in stable (not necessarily clear) weather conditions.

Should effective range be limited in these conditions, check to see that your CB is connected properly and your antenna adjusted correctly. It may be necessary to consult your Midland CB Dealer's service department.

What causes noise?

If you have an abnormal noise problem, the chances are your vehicle itself is the cause.

A CB receiver is a very sensitive instrument, able to pick up small noise signals and amplify them — particularly if the source of these signals is within a few feet of your CB.

Any noise that comes from your CB almost certainly comes from outside the unit itself. Devices have been designed into your Midland CB (a noise blanker or an automatic noise limiter, for example) to minimize this kind of distraction.

Trouble-shooting aids.

Frequently, there are simple, quick actions you can take to eliminate or minimize such problems as interference and noise.

Noise suppression.

A very common source of excessive noise is the ignition system of a CB owner's vehicle. If you suspect this is true, simply turn off the ignition and set the key in the accessories (ACC) position.

This way you'll provide power to the transceiver, minus any ignition interference that might exist. If the noise goes away, you know instantly that the ignition system is the culprit.

Still, there are a number of places in the ignition system where noise can originate.

Sparkplugs and sparkplug wires are probably the worst noise producers. To eliminate this kind of noise, you can take any of four simple measures: (1) Install resistive sparkplug suppressors, (2) resistor sparkplugs or (3) resistance-wire cabling, between plugs and the distributor and also between the distributor and ignition coil. (4) Replace old plugs and sparkplug wiring and properly tune the engine. This generally cures most noise.

Many cars come suppressor-cable equipped. If yours didn't (consult your vehicle owners manual or dealer service department to be sure), you can get it at any auto supply store and, given a moderate amount of mechanical skill, install it yourself.

Caution: Do not undertake any ignition-system repairs or modifications without either professional help or some automotive service experience.

Generator-brush sparking can create an annoying "whine." It's caused by a dirty commutator, and is eliminated by polishing its surface with fine-grade emery cloth, and cleaning grooves with a small, sharp tool.

Voltage regulators can cause a "hashy" sound in your CB when relay contacts jitter open and closed when the battery is fully charged. To eliminate this noise, mount coaxial feedthrough capacitors at the battery and armature terminals on the regulator box.

Alternator slip rings should also be kept clean and good brush contact maintained to minimize CB noise.

In addition, single-contact alternator regulator boxes need a coaxial capacitor at the ignition terminal. Double-contact units should have a second capacitor at the battery terminal. Shielding between the regulator and alternator may be needed as well. Be sure to ground the shield at both ends.

Infrequent, though real, noise generators like your car's heater fan, turn signals, electric windows and windshield-wiper motors can also be silenced with a coaxial capacitor (consult your serviceman).

Wheels and tires can also cause CB noise. Wheel noise is eliminated by putting static-collector springs between the wheel spindle bolt and grease retainer cup. Tire static can be quieted with antistatic powder applied inside each wheel.

Antenna corona-discharge noise — most frequently occurring with sharp-pointed "whip" models — can happen just before or during electrical storms. The only cure is for the storm to blow over or pass.

Frequency-channel number chart.

Frequency	Channel
26.965 MHz	1
26.975 MHz	2
26.985 MHz	3
27.005 MHz	4
27.015 MHz	5
27.025 MHz	6
27.035 MHz	7
27.055 MHz	8
27.065 MHz	9
27.075 MHz	10
27.085 MHz	11
27.105 MHz	12
27.115 MHz	13
27.125 MHz	14
27.135 MHz	15
27.155 MHz	16
27.165 MHz	17
27.175 MHz	18
27.185 MHz	19
27.205 MHz	20
27.215 MHz	21
27.225 MHz	22
27.255 MHz	23
27.235 MHz	24
27.245 MHz	25
27.265 MHz	26
27.275 MHz	27
27.285 MHz	28
27.295 MHz	29
27.305 MHz	30
27.315 MHz	31
27.325 MHz	32
27.335 MHz	33
27.345 MHz	34
27.355 MHz	35
27.365 MHz	36
27.375 MHz	37
27.385 MHz	38
27.395 MHz	39
27.405 MHz	40

OPERATION THEORY OF PLL FREQUENCY
SYNTHESIZING AM/SSB CB TRANCEIVER

1. PLL CIRCUIT

1. Fundamental Theory of PLL Circuitry

The word PLL is an abbreviation of the "Phase Locked Loop" in which a given signal is processed to track the frequency and phase of a reference signal. In other words, the PLL is of an automatic frequency control loop or automatic phase control. The PLL circuitry consists of the three main units in simple form as shown in Figure 1.

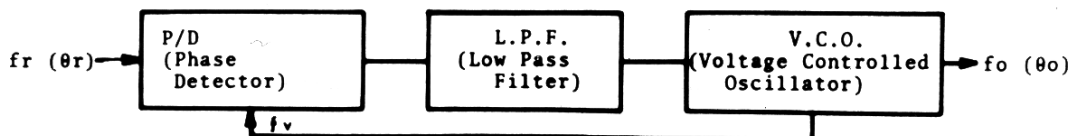

Fig. 1 Fundamental Block Diagram of PLL Circuitry

Fig. 1 Fundamental Block Diagram of PLL Circuit

In the above block diagram when the reference frequency f_r and the VCO output frequency f_v are applied to the Phase Detector P/D, the f_v is compared with f_r in terms of phase lag and lead. Then the resulting output (phase difference) is converted into DC output voltage corresponding to the phase difference. Since the phase comparison is made at every cycle and it may contain noise, the DC output is fed to the low pass filter (LPF) and integrated or filtered to continuous DC voltage in proportion to the phase difference. The frequency of the voltage controlled oscillator (VCO) is controlled by the LPF output voltage. Thus controlled VCO output is then split in two: one is used as an operating frequency of the unit and another is returned to the P/D to make a closed loop. The closed loop will continue to operate until the following condition is met:

$$\theta_r(t) = \theta_o(t)$$

This condition is called locked.

Employing the PLL system into a CB transceiver requires some modifications so that the VCO generates a specific frequency corresponding to each channel frequency (26.965MHz-27.405MHz) in relation to a channel selection.

2. Operation Theory of Actual PLL Circuit

The actual frequency synthesizing circuit of the transceiver includes two standard crystal oscillators. The first oscillator (OSC 1) consists of a crystal X1 and IC1 and is oscillating at a frequency of 10.240MHz during all modes of operation. The 10.240MHz frequency is divided in two frequencies by the divider provided inside the IC1. The two frequencies are 5.120MHz and 5KHz.

- (a) The 5.120MHz is then tripled through a tripler circuit and the tripled output (15.36MHz) is applied to the IC2 mixer.
- (b) The 5KHz signal is applied to the phase detector (P/D) inside the IC1 and used as the reference signal.

The second oscillator consisting of crystal X2 and transistor Q3 is designed to oscillate at 10.46675MHz during AM mode of operation (10.46800 MHz during USB and 10.46550MHz during LSB). The Q3 oscillator is oscillated at USB frequency of 10.46800MHz, but when the mode switch is placed in the LSB position, the LSB shift switch transistor Q4 is turned on, thereby connecting the shift capacitors, (C22 & CT3) to the crystal X2 and shifting the frequency to 10.46550MHz. When the mode switch is placed in the AM position, the AM shift switch Q5 operates and connects CT2 to the crystal. In this way 10.4655MHz and 10.46675MHz frequencies are generated for LSB and AM mode of operation respectively. Thus produced oscillator 2 frequency is fed to the doubler circuit (T1) and the doubled output (20.9335MHz for AM, 20.9360MHz for USB and 20.9310MHz for LSB) is applied to the IC3 mixer.

On the other hand, the voltage controlled oscillator (VCO) consisting of the VCO OSC block and VCO inside IC3 is designed to be controlled by the DC voltage provided by the phase detector of IC1 and is oscillated at 16.725MHz when channel 1 is selected (17.165MHz for channel 40). The VCO output frequency is fed to the IC3 mixer and mixed with the doubler output (T1) frequency. The resultant output is 37.6585MHz for AM channel 1, 37.661MHz for USB channel 1 & 37.656MHz for LSB channel 1. This output frequency is used as a 37MHz 1st local oscillator frequency to generate transmit or receive IF frequencies.

A part of the VCO output (16.725MHz for CH1-- 17.165MHz for CH40) is fed to the IC2 mixer (pin4) and mixed with the 15.360MHz signal fed from the tripler network (C21, L1). The resultant difference output is 1.365MHz (for CH1) and this is fed to the programmable divider of IC3, which is preset to divide its input into 5KHz frequency by the channel selector. Then, the divided 5KHz signal is fed to the phase detector and compared with the phase of another 5KHz reference signal sent from the fixed divider of IC1. The phase detector develops a DC error signal corresponding to the phase difference between the two signals. This DC error signal is then fed to the VCO OSC block through an active low pass filter (IC1, R2, R3, C3) and controls the VCO frequency until the VCO frequency (more accurately the VCO frequency divided by programmable divider) exactly coincides with the 5KHz reference signal. Once the phase lock is established, the VCO output frequency is stabilized in the same order as that of crystal-controlled oscillator.

2. AM/SSB TRANSMITTER

SSB Transmission

During transmit mode of operation, the third crystal oscillator consisting of crystal X3 and transistor Q6 is powered and oscillates at a frequency of 10.6935MHz for AM, 10.696MHz for USB and 10.6910MHz for the LSB mode of operation. Actually, the Q6 is being oscillated at USB frequency of 10.696MHz, but when the mode switch is placed in the LSB position, the base shift switch transistor Q7 is biased and the shift network consisting of CT6 and C33 is grounded (connected to crystal X3), resulting in decreasing oscillating frequency to 10.6910 Hz. In the similar way, when the mode switch is placed in the AM position, the transistor Q8 is turned on and connects the CT5 to the crystal, thus decreasing the oscillating frequency to 10.6935MHz. Thus generated oscillator frequency is fed to the Balanced Modulator IC5 (pin3). The balanced modulator is designed to produce a carrier suppressed double side band (DSB) signal when an audio signal amplified with the MIC amplifier IC7 is applied to the pin 1 of IC5.

Thus produced DSB signal is fed to the narrow band crystal filter CF through R109, C132, & D24 to separate a desired side band (USB or LSB). The selected side band signal is applied to the IC4 and the amplified output is finally fed to the balanced mixer consisting of Q9 and Q10 through a coupling capacitor C44 and T4. Since 37.661MHz first local frequency is being applied to this mixer through T2, T3 and C43 (in case of CH1 USB mode of operation), the side band signal (10.696MHz in case of CH1 USB mode of operation) is mixed with the 37.661MHz signal, thus resulting in transmit frequency of 26.965MHz (CH1). The transmit SSB signal is then fed to the linear amplifiers: balanced pre-amplifier (Q11 and Q12), driver Q13 and final RF power amplifier Q14. The amplified output is applied to the antenna connector through a low pass filter (L14, L15, L16 etc.) and an antenna warning circuit provided on a separate printed circuit board. The low pass filter serves to pass the 27MHz signal but attenuates undesirable higher frequency signals. It also serves to match the impedance to the RF power amplifier output circuit.

2. AM Transmission

Since the balanced modulator IC5 is designed to suppress carrier frequency, no carrier signal is obtained if the 10.6935MHz signal for AM is applied to its input circuit (pin 3). However if modulator balance is upset by adding an external circuit, the carrier can be generated. This operation is performed by the transistor Q27. When the mode switch is placed in the AM position, the base of Q27 is biased and Q27 is turned on, making the balanced modulator unbalanced, and develops a carrier signal. Thus produced 10.6935MHz carrier signal is led to the TX mixer (Q9 and Q10) in the same way as stated in the SSB transmission above, and mixed with the first local frequency (37.6585MHz for CH1) being applied from the PLL section. The resultant frequency is 26.965MHz (CH1) transmit signal. The signal is then fed to the RF amplifiers consisting of Q11, Q12, Q13, and Q14, and the amplified output is applied to the antenna connector in the same way as shown in "SSB Transmission".

Q28 is a switching transistor which is biased during AM TX mode of operation, thereby increasing AM carrier level of the IC5.

During AM TX mode of operation, the microphone signal is applied to the pin 6 of MIC amplifier IC7 through the MIC gain control R501 and C136, --C140, and the amplified output is fed to pin 1 of AF amp: IC8 through C143--RV9--R139. Thus amplified audio output is then applied to each collector of Q13 and Q14 through a matching transformer T13 and a diode D47, thereby modulating the 27MHz transmit carrier signal up to 100%.

Q34 and Q35 are switching transistors. During AM transmit mode of operation, the base of Q35 is biased and Q35 is turned on and this makes Q34 turn off, then the input circuit of IC8 is released. On the other hand the Q35 is turned off during SSB transmit mode and Q34 is turned on, thus the input circuit of IC8 is grounded through C186 and emitter-collector junction of Q34, because the IC8 is non-functional during SSB transmit operation. In the similar way the transistor switch Q33 is turned on during SSB transmit operation and connects the input circuit of AF pre-amplifier Q32 to ground silencing the AF amplifier.

A portion of the MIC amplifier output is fed to the ALC amplifier Q31 and its output is rectified by diodes D42 and D43, the resultant DC output voltage is applied to the gate of ALC FET Q30, thus controlling the

input signal level to the microphone amplifier to prevent over modulation.

3. AM/SSB RECEIVER CIRCUIT

When an incoming signal is applied to the antenna it is fed to the RF amplifier Q8 through a coupling capacitor C79 and T8 and amplified. The amplified signal is fed to the mixer (Q19 and Q20) through a tuned circuit T9 and mixed with the first local oscillator frequency being applied to the bases of the mixer from the PLL section through a coupling capacitor C85. The resultant IF signal (10.69MHz band) is applied to the crystal filter, IF amplifier IC4 and Q24. The amplified IF output is split in two: (a) one is applied to the AM detector diode D33 and (b) another is fed to the SSB detector of Q29 (where 10.696MHz for USB or 10.691MHz for LSB signal is being applied from OSC 3 to detect audible signal from the SSB signal). Each detected audio signal is fed to the pre-amplifier Q32, then to the power amplifier IC8 to drive the speaker.

Transistors Q17 and Q39 comprise a switching circuit which makes the input circuit of RF amplifier short-circuit to ground, thus protecting the RF amplifier from breakdown during transmit. Diodes D17 and D18 in the input circuit are provided to prevent signal overload distortion during receive operation.

Squelch Circuit

When the receiver receives a weak or no signal, the AGC voltage applied to pin 1 of IC6 decreases, this increases the output voltage of IC6 and makes Q26 turn on. Since the collector of Q26 is connected to the audio detector output/volume control, the audio signal is passed to ground, thus muting the audio signal. With a proper strength of signal input received, Q26 is cut off and the audio signal is fed to the audio amplifier.

AGC Circuit

A portion of the IF signal is sampled from IF amplifier Q24 to obtain AGC voltage. The sampled IF signal is applied to diode D27 through C104 and the rectified output is fed to the AGC amplifier Q25 and a DC switch Q41 provided to improve AGC attack time. The amplified DC output is split in two: one is applied to the base of RF amplifier through RF gain control and the other if fed to the IF amplifier through R82 and to the squelch control IC6 through R83.

Noise Blanker

Undesirable noise such as ignition or any other impulse noises are mixed with incoming signals received. They are picked up at the mixer output and amplified by the noise amplifier Q21. The amplified outputs are rectified by D20 and D21, and the rectified outputs are further fed to the noise amplifier Q22. The final noise outputs are then fed to the switching transistor Q23 and Q23 turns on. Since the Q23 is connected to the secondary coil of T10, the mixer output is short-circuited to the ground and no mixer output is transferred to the next stage during reception of impulse noises, thus blanking out the undesirable noises.

Clarifier

Receiver clarifying is performed by varying the 1st local oscillator frequency. In actual circuit, the OSC 2 (Q3) frequency is varied by chang-

ing the DC voltage applied to the varicap diode D4 connected to the oscillator.

4. POWER SUPPLY CIRCUIT

The power supply circuit consists of three types:

- (a) Transmit power supply circuit controlled by the transistor Q38.
- (b) Receive power supply circuit controlled by transistor Q37.
- (c) Regulated power supply circuit for biasing critical circuits Q36.

ALIGNMENT PROCEDURES FOR AM/SSB TRANCEIVER

1. MEASUREMENT CONDITION

- (1) Test Voltage :DC 13.8V + 1%, unless otherwise specified

2. TEST EQUIPMENT

All test equipment should be properly calibrated.

- (1) Oscillator, Sine Wave 500 Hz/2.4 kHz, Output Impedance 600 ohm unbalanced.
- (2) V.T.V.M., 1 mVrms - Vrms measurable, or higher.
- (3) Regulated Power Supply, DC 0 - 17 V, 3A or higher.
- (4) Frequency Counter, 0 - 30 MHz High Input Impedance Type.
- (5) RF V.T.V.M., Probe Type
- (6) Oscilloscope, 30 MHz High Input Impedance.
- (7) RF Watt Meter, Thermo-couple Type, 50 Ohm, 5W/15W.
- (8) Spectrum Analyzer, Band Width, Nearby Spurious, Measurable.
- (9) Standard Signal Generator, 100 kHz - 50 MHz, -10 dB - 100dB 50 ohm unbalanced.
- (10) Dummy Resistive Load, 8 ohms + 2%, 5W
- (11) Circuit Tester, DC 20k ohm/V, High Input Impedance Type.
- (12) Pulse Generator, Repeat Frequency 10 - 500 Hz Variable Impedance 50 ohm unbalanced.

3. PLL CIRCUIT ALIGNMENT

3.1 Setting

Set the power supply voltage to 13.8V DC.

Couple the high input impedance probe to the frequency counter.

Place the channel selector to any channel position.

Place the CB-PA switch in the CB position.

NOTE: This alignment should be performed with a frequency counter having high sensitivity and high input impedance.

3.2 10.240MHz Frequency

Set the transceiver into the transmit or receive mode.

Couple the frequency counter probe to the test point TP1, and adjust the trimmer capacitor CT7 to obtain a frequency reading of :

10.24000MHz + 50Hz

3.3 10.691MHz Frequency

- (1) Set the transceiver in the receive or transmit mode with the mode

switch in USB position. Couple the frequency counter probe to the test point TP4, and adjust CT4 to obtain the frequency reading of:

10.696MHz + 50Hz

- (2) Set the transceiver in the transmit mode with the mode switch in AM position. Couple the counter probe to TP4 and adjust CT5 to obtain the reading of:

10.6935MHz + 50Hz

- (3) Set the transceiver in the receive or transmit mode with the mode switch in LSB position. Couple the counter probe to TP4, and adjust CT6 to obtain 10.691MHz + 50Hz.

- (4) Repeat above steps until no further improvement is obtained.

3.4 10.4667MHz Frequency

- (1) Set the transceiver in the transmit mode with the mode switch in USB position. Couple the frequency counter probe to the test point TP3, and adjust CT1 to obtain frequency reading of:

20.9360MHz + 50Hz

- (2) Next, place the mode switch in the AM position, and adjust CT2 to obtain the frequency reading of:

20.9335MHz + 50Hz

- (3) Place the mode switch in LSB position, and adjust CT3 to obtain the reading of:

20.9310MHz + 50Hz

- (4) Repeat above steps until no further improvement is obtained.
- (5) Set the transceiver in the receive mode, and verify the frequency obtained in each above step will vary by more than 1kHz when the clarifier control is adjusted in its fully counter clockwise or clockwise position. Place the clarifier in "12" o'clock position and verify the frequency obtained in each above step is obtained again.

NOTE: *All adjustments described above should be performed in the sequence instructed.

*Frequency adjust-trimmers should be preset at their center position before adjustment.

3.5 VCO Circuit

- (1) Set the transceiver in the transmit or receive mode. Connect a circuit tester (DC 12V range) between the TP2 and ground.
- (2) Place the channel selector at CH40 position.
- (3) Adjust slug provided on the VCO block to obtain voltage reading of 4.0V + 0.1V.
- (4) Next, place the channel selector at CH1 position, and verify the voltage reading is within 1.8 - 2.2V.

NOTE: The circuit tester used in this alignment should be calibrated and has input impedance of higher than 20KHz/V.

4. ALIGNMENT OF TRANSMITTER CIRCUIT

4.1 Test Set-Up

Connect all test equipment as shown below.

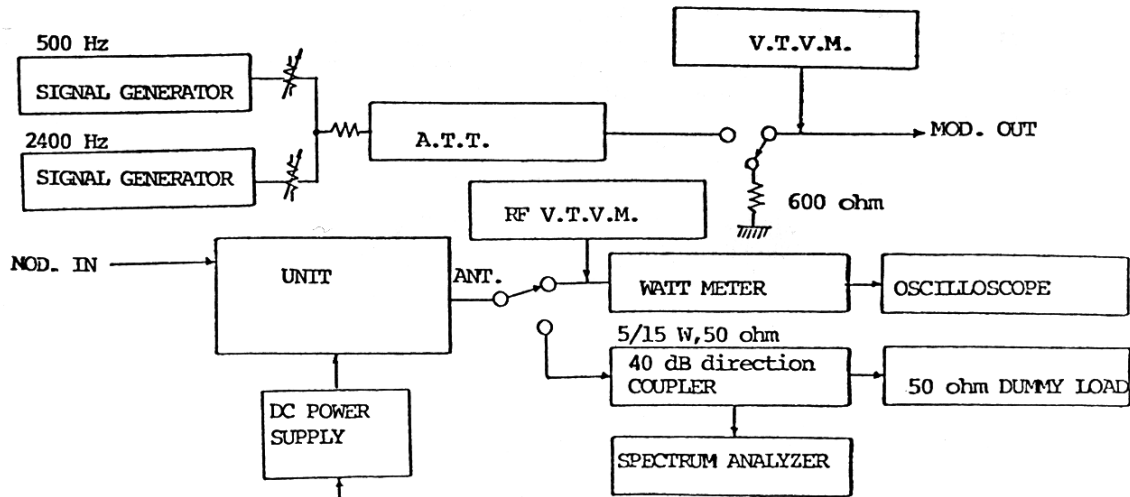

- 4.2 To place the transceiver in the transmit mode without the microphone, insert the plug wired as shown into the MIC jack on the transceiver. When injecting audio modulation signal to the microphone input circuit, use the same plug also.

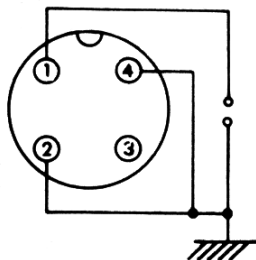

4.3 Presetting

Temporarily set RV1 fully clockwise position and L14 and L16 slugs to be flush with their coil bobbins.

4.4 Pre-Driver and Power Amplifier Stage

- (1) Place the mode switch in USB position and channel selector at CH20 position.
- (2) Apply single (2.4KHz) or two tone (500Hz and 2400KHz) signal of 10mV to the microphone input circuit and adjust the modulation signal level with RV8 to obtain RF power output of about 2W.
- (3) Next, adjust T1, T2, T3, T11, T4, T5 and T6 in this order to obtain

- maximum amplitude of scope display. (Repeat this procedure 2-3 times.)
- (4) Place RV8 in full counter clockwise position and RV10 in full clockwise position.
 - (5) Apply single tone (2.4KHz) of modulation frequency to the microphone input circuit, and adjust T7, L10, L14 and L16 for maximum power output. (Repeat this procedure 2-3 times.)
 - (6) Turn L10 slug clockwise until power output of 14.0 Watts is obtained.
 - (7) First, apply 2400Hz 10mV single tone signal to the microphone input circuit. Next, apply 500Hz signal to the microphone input circuit and increase or decrease 500Hz signal level to observe crossover display on the oscilloscope. Also, verify the scope display of output wave form shown below is obtained.

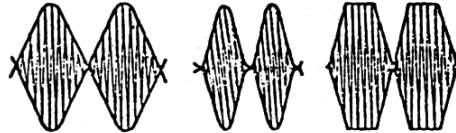

A-Correct B-Incorrect C-Incorrect

Then, adjust:

RV8 to obtain 73V (P-P) on the RF VTVM and
RV10 to obtain 66V (P-P) reading.

- (8) Make sure the power output is within 64V (P-P) to 68V (P-P) at any channel in both USB and LSB mode of operation.

4.5 AM Power Output and RF Power Meter

- (1) Place the mode switch in AM position and channel selector to CH20 position.
- (2) Adjust VR1 to obtain RF power output of 3.75W.
- (3) Make sure the power output is between 3.6-3.9W on any channel.
- (4) Adjust RV2 so that AM RF power meter of the transceiver indicates the same wattage (3.75W) as that of RF watt meter connected to the antenna connector.

4.6 AM Modulation

- (1) Apply 1KHz, 100mV modulation signal to the microphone input circuit and place channel selector to CH20 position.
- (2) Adjust RV9 to obtain 100% modulation.
- (3) Decrease the input signal level to 10mV and make sure the modulation ratio is still within 85-95% at any channel

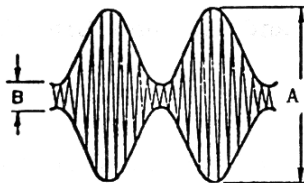

$$\text{Modulation ratio} = \frac{A - B}{A + B} \times 100(\%)$$

4.7 SSB Carrier Supression

- (1) Set the transceiver in transmit mode, no modulation.
- (2) Place the mode switch in USB position and adjust RV6 and RV7 alternately for minimum carrier leakage on scope display.
- (3) Place the mode switch in LSB position and make sure the carrier leakage level is almost the same as that in USB mode. If not, readjust RV6 and RV7 alternately.

5. ALIGNMENT OF RECEIVER CIRCUIT

5.1 Test Set-Up

Connect test equipment to the receiver as shown below.

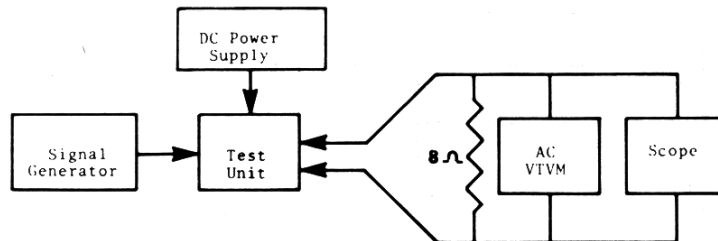

Unless otherwise specified, place the controls and switches on the transceiver as follows:

- (a) CB/PA switch in CB position
- (b) AF Gain control in Max. position
- (c) Squelch control in Min. position
- (d) Clarifier in "12" o'clock position
- (e) RF gain control in Max. position
- (f) Channel selector on CH20
- (g) Tone switch in Hi position
- (h) ANL & NB switch in Off position

5.2 To set the transceiver in receive mode, insert the microphone plug into the microphone jack.

5.3 AGC Voltage

- (1) Place the mode switch in the USB position. Open the antenna circuit of the receiver. Connect the circuit tester plus lead to RV4 and minus lead to the ground.
- (2) Adjust RV4 to obtain the voltage reading of about 1.4V.

5.4 RF Stage and Det. Coil

- (1) Set the transceiver in AM mode and adjust signal generator to provide channel frequency of 27.305MHz, 1kHz 30% modulation.
- (2) Adjust T8, T9, T10 and T12 for maximum audio output. When adjusting slugs, always keep the generator output low so that the audio output is not saturated.
- (3) Next, adjust signal generator to provide 0.5uV antenna input and verify the audio output is higher than 4V.

5.5 Squelch

- (1) Place the mode switch in AM position and adjust signal generator to provide 54dE antenna input voltage, 1kHz 30% modulation. Rotate the squelch control in full clockwise direction.
- (2) Adjust RV5 so that the audio output just appears at the speaker jack (scope display).

5.6 S-Meter

- (1) Adjust the signal generator to provide 40dB antenna input, and place the receiver mode switch in AM position.
- (2) Adjust RV3 so that the S-Meter pointer indicates "9" on the meter scale.

5.7 AM 100dB Distortion

- (1) Adjust the signal generator to provide 100dB antenna input, 1kHz 30% modulation, and adjust RV4 (AGC) so that audio distortion decreases to minimum.

FREQUENCY AND CODE CHART FOR AM/SSB TRANSCEIVER

CHANNEL NO.	CHANNEL FREQ. (MHz)	"N" BCD CODES	VCO FREQ. (MHz)	CHANNEL SW. OUTPUT	RX LOCAL FREQ. (MHz)		
			AM/USB/LSB	P1 P2 P3 P4 P5 P6	AM	LSB	USB
1	26.965	273	16.725	1 0 0 0 0 0	37.6585	37.656	37.661
2	26.975	275	16.735	0 1 0 0 0 0	37.6685	37.666	37.671
3	26.985	277	16.745	1 1 0 0 0 0	37.6785	37.676	37.681
4	27.005	281	16.765	0 0 1 0 0 0	37.6985	37.696	37.701
5	27.015	283	16.775	1 0 1 0 0 0	37.7085	37.706	37.711
6	27.025	285	16.785	0 1 1 0 0 0	37.7185	37.716	37.721
7	27.035	287	16.795	1 1 1 0 0 0	37.7285	37.726	37.731
8	27.055	291	16.815	0 0 0 1 0 0	37.7485	37.746	37.751
9	27.065	293	16.825	1 0 0 1 0 0	37.7585	37.756	37.761
10	27.075	295	16.835	0 0 0 0 1 0	37.7685	37.766	37.771
11	27.085	297	16.845	1 0 0 0 1 0	37.7785	37.776	37.781
12	27.105	301	16.865	0 1 0 0 1 0	37.7985	37.796	37.801
13	27.115	303	16.875	1 1 0 0 1 0	37.8085	37.806	37.811
14	27.125	305	16.885	0 0 1 0 1 0	37.8185	37.816	37.821
15	27.135	307	16.895	1 0 1 0 1 0	37.8285	37.826	37.831
16	27.155	311	16.915	0 1 1 0 1 0	37.8485	37.846	37.851
17	27.165	313	16.925	1 1 1 0 1 0	37.8585	37.856	37.861
18	27.175	315	16.935	0 0 0 1 1 0	37.8685	37.866	37.871
19	27.185	317	16.945	1 0 0 1 1 0	37.8785	37.876	37.881
20	27.205	321	16.965	0 0 0 0 0 1	37.8985	37.896	37.901
21	27.215	323	16.975	1 0 0 0 0 1	37.9085	37.906	37.911
22	27.225	325	16.985	0 1 0 0 0 1	37.9185	37.916	37.921
23	27.255	331	17.015	1 1 0 0 0 1	37.9485	37.946	37.951
24	27.235	327	16.995	0 0 1 0 0 1	37.9285	37.926	37.931
25	27.245	329	17.005	1 0 1 0 0 1	37.9385	37.936	37.941
26	27.265	333	17.025	0 1 1 0 0 1	37.9585	37.956	37.961
27	27.275	335	17.035	1 1 1 0 0 1	37.9685	37.966	37.971
28	27.285	337	17.045	0 0 0 1 0 1	37.9785	37.976	37.981
29	27.295	339	17.055	1 0 0 1 0 1	37.9885	37.986	37.991
30	27.305	341	17.065	0 0 0 0 1 1	37.9985	37.996	38.001
31	27.315	343	17.075	1 0 0 0 1 1	38.0085	38.006	38.011
32	27.325	345	17.085	0 1 0 0 1 1	38.0185	38.016	38.021
33	27.335	347	17.095	1 1 0 0 1 1	38.0285	38.026	38.031
34	27.345	349	17.105	0 0 1 0 1 1	38.0385	38.036	38.041
35	27.355	351	17.115	1 0 1 0 1 1	38.0485	38.046	38.051
36	27.365	353	17.125	0 1 1 0 1 1	38.0585	38.056	38.061
37	27.375	355	17.135	1 1 1 0 1 1	38.0685	38.066	38.071
38	27.385	357	17.145	0 0 0 1 1 1	38.0785	38.076	38.081
39	27.395	359	17.155	1 0 0 1 1 1	38.0885	38.086	38.091
40	27.405	361	17.165	0 0 0 0 0 0	38.0985	38.096	38.101

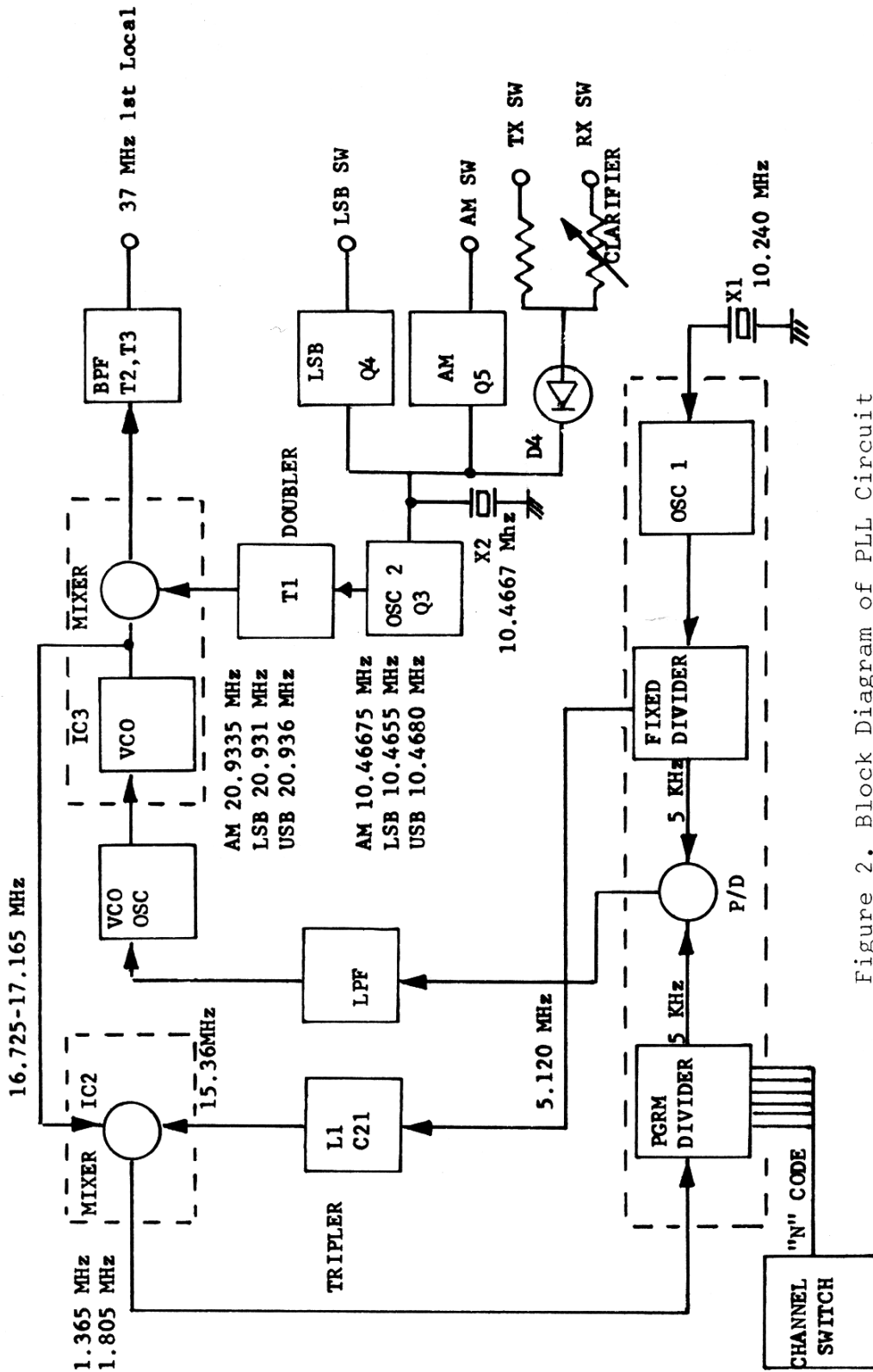
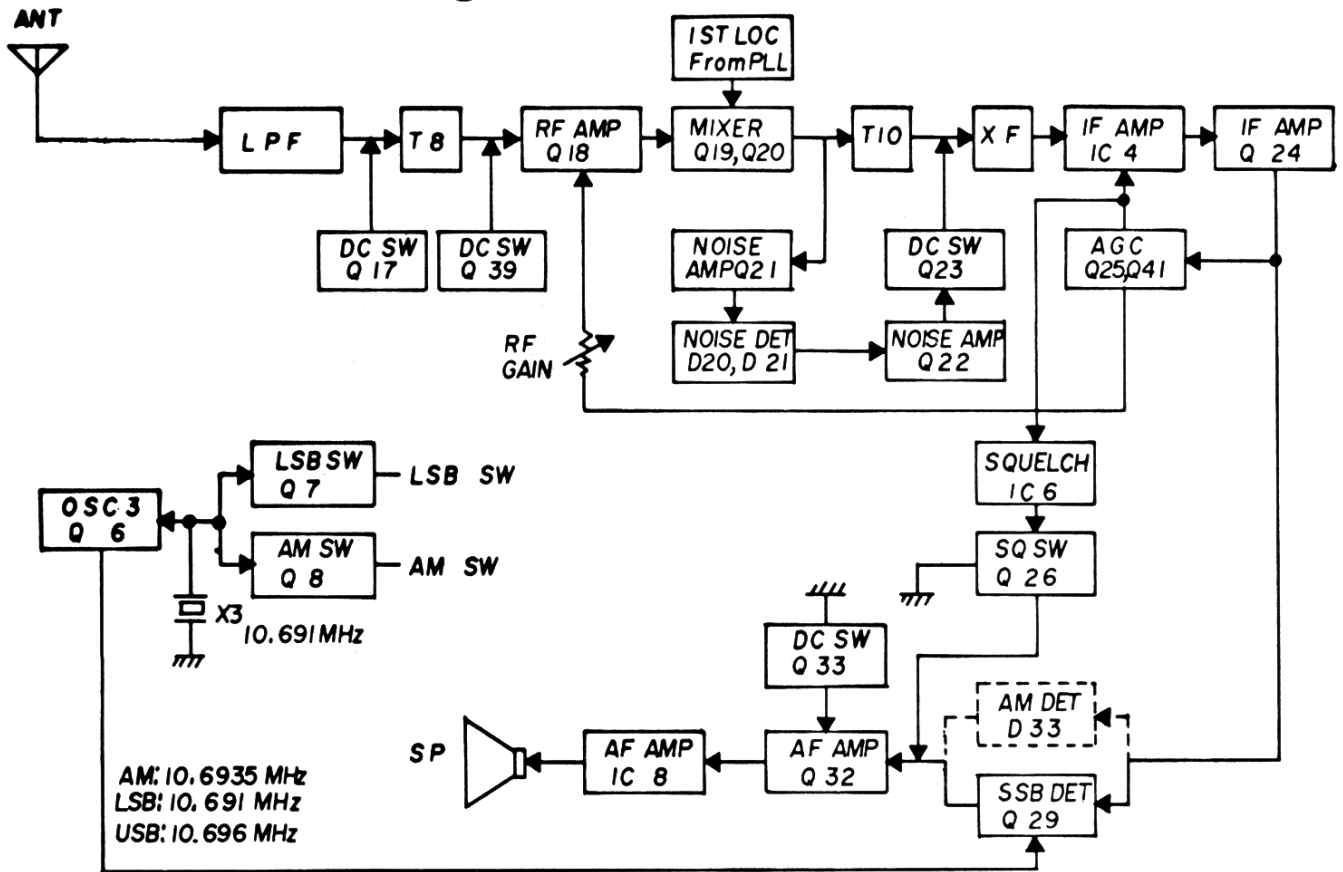
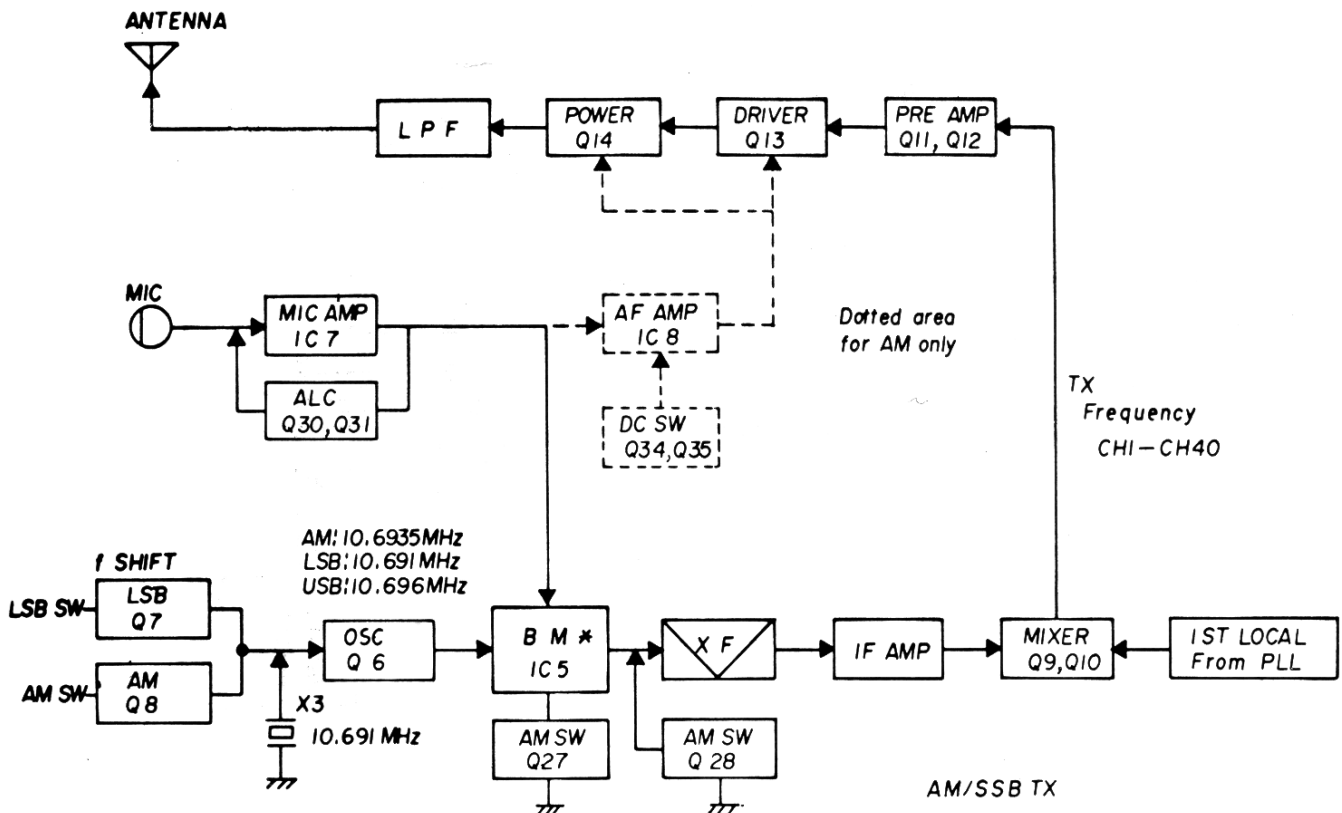

Figure 2. Block Diagram of PLL Circuit

Block Diagram



AM / SSB RX



AM/SSB TX

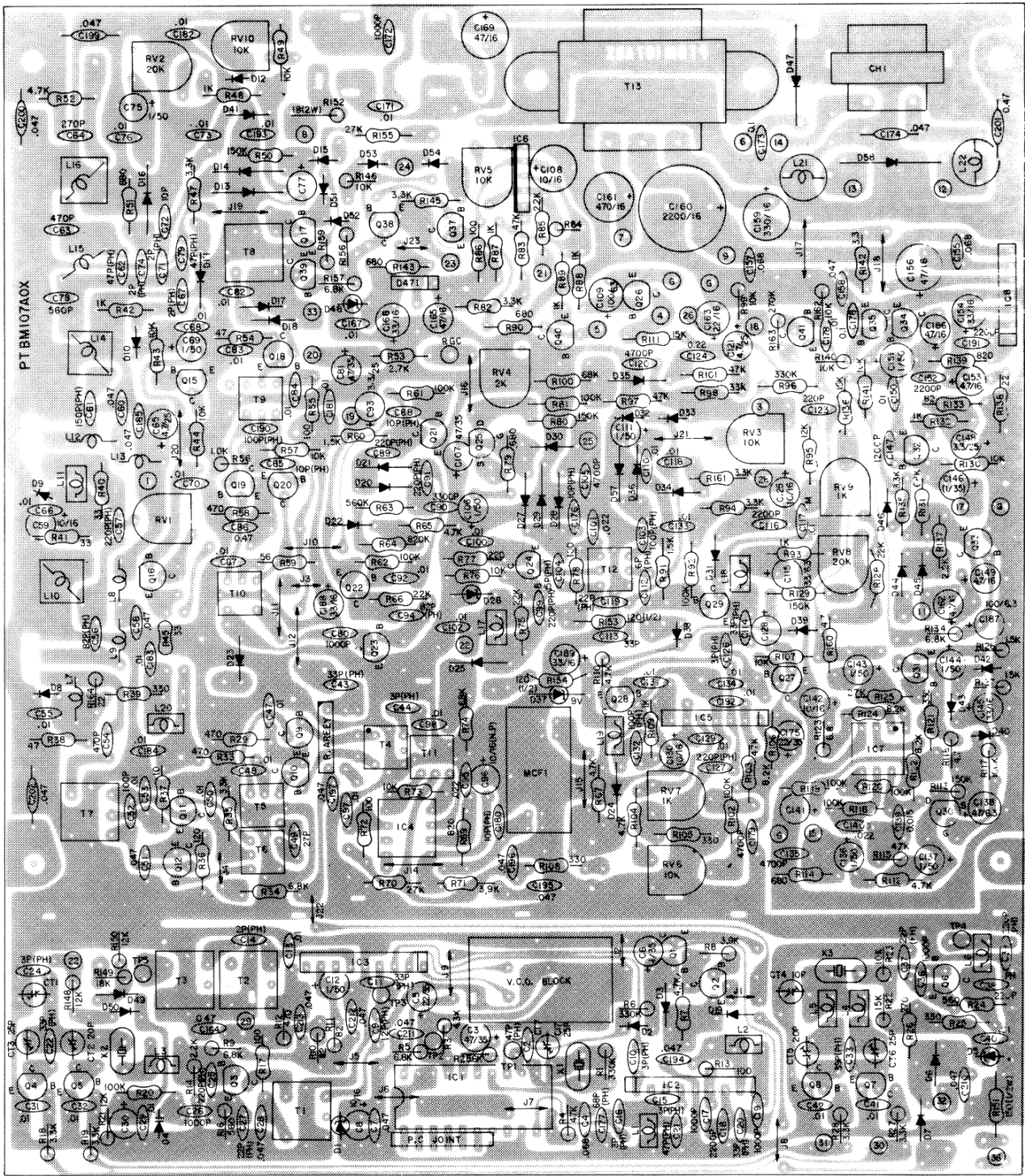

TOP VIEW

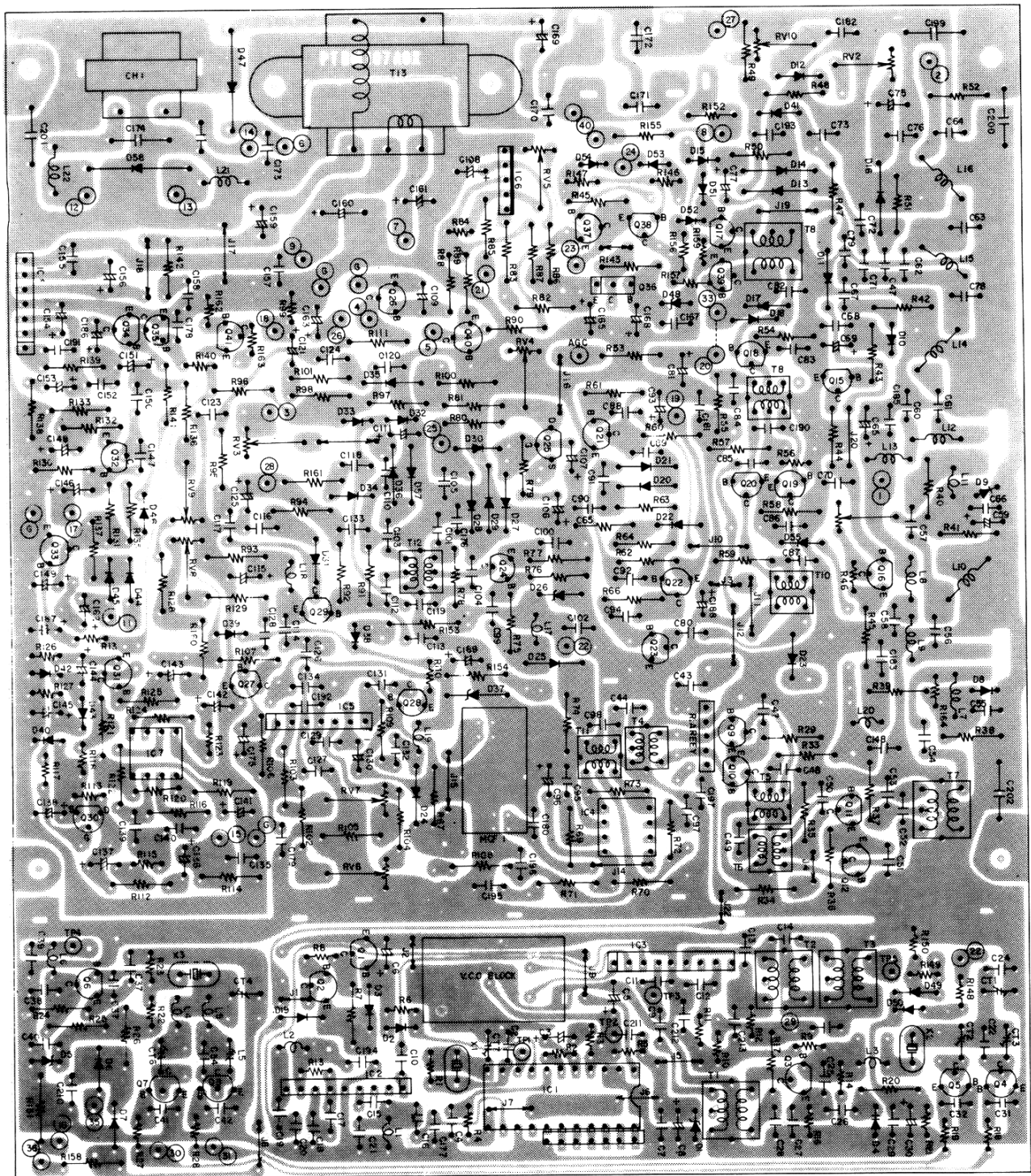

BOTTOM VIEW

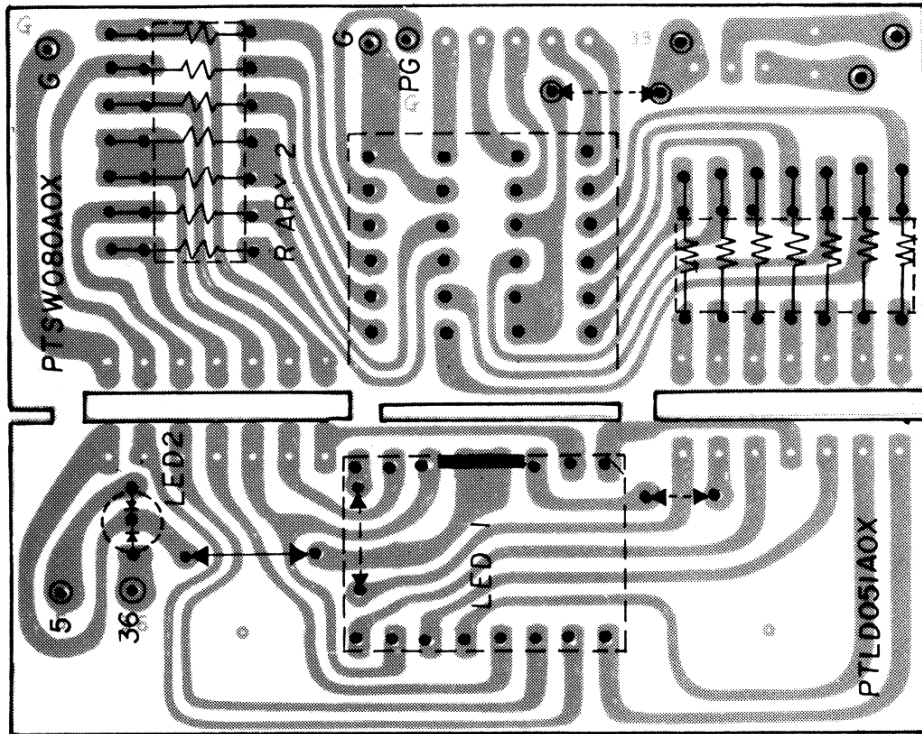
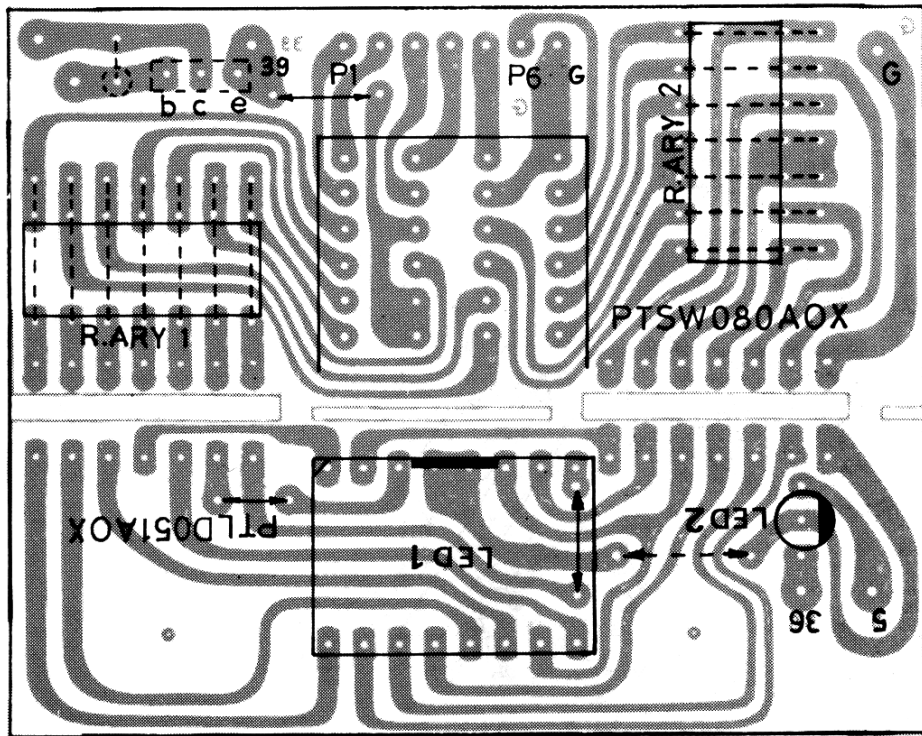

MODEL 6001

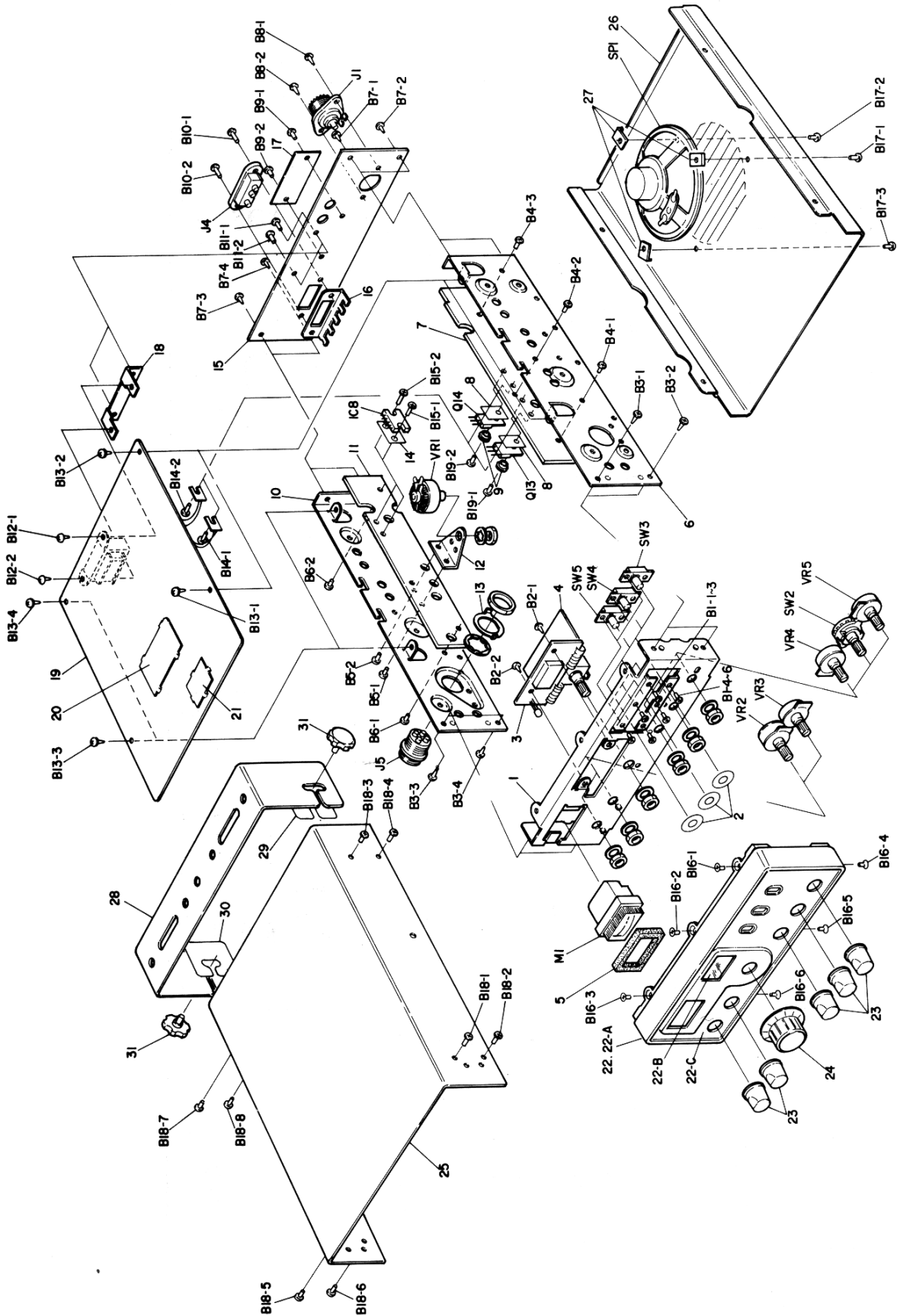

EXPLODED VIEW

PARTS LIST

MODEL NO. 79-006

PAGE NO. 1

<u>REF. NO.</u>	<u>DESCRIPTION</u>	<u>PART NO.</u>	<u>REF. NO.</u>	<u>DESCRIPTION</u>	<u>PART NO.</u>
<u>CASE MATERIAL:</u>			<u>COILS & TRANSFORMERS (Cont.)</u>		
22-C	Escutcheon	79-020013	L10	R.F. Coil	79-176043
22-A	Frame	79-015001	L16	R.F. Coil	79-176044
22	Escutcheon Assy.	79-020014	L14	R.F. Coil	79-176045
1	Front Panel	79-010012	T1	R.F. Coil	79-176046
10	Side Panel L	79-013007	T2	I.F.T.	79-090018
6	Side Panel R	79-013008	T3	R.F. Coil	79-176047
15	Rear Panel	79-013009		<u>LEDs</u>	
26	Cover B	79-011006	LED2	L.E.D.	79-202003
25	Cover A	79-011007	LED1	L.E.D.	79-202004
17	Ser. # Plate	79-012003		<u>RESISTOR MODULES</u>	
23-1,2,3,4,5	VR Knob	79-110004	R-AREY	Resistor Array	79-130001
24	Ch Knob	79-115008		<u>BOARDS</u>	
	<u>MISCELLANEOUS</u>			P.W. Board W/O Comp.	79-070005
	Short Jumper	79-034007		VCO Block W/Comp.	79-070011
	Conn. Cord Assy.	79-159010	V.C.O.	P.W. Board W/O Comp.	79-070012
	Conn. Cord Assy.	79-159011		P.W. Board W/O Comp.	79-070013
	Assy. Wire Kits	79-034008		P.C. Joint	79-070014
M1	Meter	79-200004		P.C. Joint	79-070015
SP1	Speaker	79-060004		P.W.B. Assy. W/Comp.	79-075013
27-1,2,3	Bracket	79-158030		P.W.B. Assy. W/Comp.	79-075014
12	Bracket	79-158031		P.W.B. Assy. W/Comp.	79-075015
18	Retainer	79-158032		<u>FILTERS</u>	
16	Bracket	79-158033		Filter	79-179009
11	Heatsink	79-089026		M-Xtal Filter	79-179008
7	Heatsink	79-089027		<u>DIODES</u>	
13	Washer	79-157007		D4	Varicap Diode ITT310
	Bushing	79-157008		D10,D16,D20,	
	Barrier	79-089028		D21,D29,D32,	
	Label	79-012002		D33,D36,D57	Diode 1K261
	Cord, DC Assy.	79-034006		D47	SI Diode GP25G
	Screw, Pan Tap	79-151012	MXF	D2,3,6,7,11,	
	Screw, Truss Tap	79-151016		12,13,14,15,	
	Screw, Bras Tap	79-151013		17,18,19,22,	
	Lockwasher, O.T.	79-157009		23,24,25,27,	
	Lockwasher, I.T.	79-157010		28,30,31,34,	
	Screw	79-151017		35,38,39,41,	
	Handle	79-028002		42,43,44,45,	
	Mic, Holder	79-158029		46,49,50,51,	
	Sheet L	79-089029		52,53,54,55,	
	Sheet R	79-089030		201	SI Diode 1N4448
	Microphone	79-038004		D58	SI Diode RA1Z
	<u>JACKS</u>			D1	Zener Diode
J2	Jack, 3 Pin	79-153001		D5,26,37,48	Zener Diode RD9
J4	Jack, DC	79-153002		D40	Varistor (SV03 VF:1.6 V-2.00V)
J1	Jack, Antenna	79-153003		D8,D9	Varistor MVIYH
J5	Jack	79-153004			05-470000
	<u>SWITCHES & CONTROLS</u>			<u>CRYSTALS</u>	
RV9	Control, Sens., 1K ohm	79-164019		X1	Xtal Osc. 10.240
RV3,RV5,RV7	Control, Sens., 10K ohm	79-164020		X2	Crystal Osc. 10.4667
RV4	Control, Sens., 2K ohm	79-164021		X3	Crystal Osc. 10.691
RV2,6,8	Control, Sens., 20K ohm	79-164022			79-128016
RV1	Control, Sens.	79-164023		<u>INTEGRATED CIRCUITS</u>	
SW1	Switch, Chan. Sel.	79-180008		IC5	I.C. AN612
VR4	Clarifier, 50K	79-166005		IC2,3	I.C. TA7310P
VR3,VR5	Control, RF Gain/Sq.50K	79-164026		IC8	I.C. UPC 1182
VR2	Control, AF/PA Gain 50KD	79-166004		IC7	I.C. 4558D
VR1	V.R. 6 ohm 10W	79-160007		IC6	I.C. M51204
SW2	Upper & Lower Switch	79-183005		IC4	I.C. SN76600
SW3,SW4,SW5	Switch, NB/ANL,CB/PA	79-183004		IC1	I.C. UPD2816C
	<u>COILS & TRANSFORMERS</u>				02-010612
L15	Coil	79-176037			02-257310
L21,L22	Choke Coil	79-178023			02-301182
L12	R.F. Coil	79-176051			02-004558
L7,L9	R.F. Coil	79-176052			02-161204
L8,L13	R.F. Coil	79-176038			02-217660
L17	R.F. Coil	79-176032			02-392816
L1,L3,L6	R.F. Coil	79-176049			
L4,L5	R.F. Coil	79-176050			
L2,11,18,					
19,20	R.F. Coil	79-176048			
CH1	Choke Coil	79-178029			
T13	AF O.P.T.	79-096015			
T5	R.F. Coil	79-176039			
T6	R.F. Coil	79-176040			
T9	R.F. Coil	79-176041			
T4,T10,T11	I.F.T.	79-090016			
T12	I.F.T.	79-090017			
T8	R.F.T.	79-090019			
T7	R.F. Coil	79-176042			
				<u>TRANSISTORS</u>	
			Q2,22	2SA733	01-010733
			Q16,38	2SB564	01-020564
			Q1,3,4,5,6,		
			7,8,9,10,11,		
			12,19,20,21,		
			23,24,26,28,		
			39	2SC710	01-020564
			Q17,31	2SC900	01-030900
			Q15,27,29,		
			32,33,34,35	2SC945A	01-030945
			Q14	2SC1969	01-031969

PARTS LIST

MODEL NO. 79-006

PAGE NO. 2

REF. NO.	DESCRIPTION	PART NO.	REF. NO.	DESCRIPTION	PART NO.
	<u>TRANSISTORS (Cont.)</u>			<u>CAPACITORS-CERAMIC TYPE</u>	
Q18	2SC1973	01-031973	C56,94	82 pf, 50V	06-000280
Q13	2SC2166	01-032166	C17,19,36,		
Q36,37	2SD471	01-040471	80,172	1000 pf, 50V	06-000393
Q25	2SK34	01-070034	C13,29,31,		
Q30	2SK136	01-070136	32,41,42,47,		
			48,50,51,53,		
			55,68,100,102,		
			110,118,122,		
			129,131,134,		
			167,170,171,		
			173,178,181,		
			182,183	.01 mfd, 50V	06-000046
			C26	1000 pf, 50V	06-000393
			C14,124,150	2 pf, 50V	06-000085
			C155	.068 pf, 50V	06-000108
			C139	.015 pf, 50V	06-000052
			C4,157	.068 pf, 50V	06-000108
			C14,67,71,74	2 pf, 50V	06-000085
			C10,15,16,44	3 pf, 50V	06-000090
			C126	8 pf, 50V	06-000130
			C72,88,176,		
R37	10 ohm, 1/4W	04-001031	180	10 pf, 50V	06-000135
R13,17,55,			C112	6 pf, 50V	06-000115
72,78,86,108	100 ohm, 1/4W	04-001200	C9	12 pf, 50V	06-000140
R15,42,48,58,			C64,147	270 pf, 50V	06-000332
87,88,93,109,			C54,63	470 pf, 50V	06-000355
133	1K ohm, 1/4W	04-000013	C78	560 pf, 50V	06-000370
R23,35,43,44,			C52,103,127,		
49,57,73,76,			132	100 pf, 50V	06-000285
99,107,130,			C104	15 pf, 50V	06-000160
140,141,147,			C61	150 pf, 50V	06-000300
150	10K ohm, 1/4W	04-001030	C1,37,85,119	22 pf, 50V	06-000180
R20,61,62,81,			C25,38,39,		
92,102,116,			57,99	220 pf, 50V	06-000320
117,119,120	100K ohm, 1/4W	04-001003	C89,91,123	220 pf, 50V	06-000320
R84	1M ohm, 1/4W	04-001600	C11,27,43,		
R36	120 ohm, 1/4W	04-001210	45,46,49,113,		
R158	1.2K ohm, 1/4W	04-001240	114	33 pf, 50V	06-000210
R60,126	1.5K ohm, 1/4W	04-001540	C2,21,62,79	47 pf, 50V	06-000235
R22,34,91,			C20	56 pf, 50V	06-000250
111,127,136,			C177	68 pf, 50V	06-000265
155	15K ohm, 1/4W	04-001530	C18,116,152	2200 pf, 50V	06-000375
R50,80,113,			C95,101	.022 mfd, 50V	06-000076
129	150K ohm, 1/4W	04-001503	C90	3300 pf, 50V	06-000380
R148,149	18K ohm, 1/4W	04-001800	C105,120,		
R77	220 ohm, 1/4W	04-002210	135,179	4700 pf, 50V	06-000396
R14,56,85,			X7,28,40,		
137	2.2K ohm, 1/4W	04-002400	58,60,66,		
R66,75,128	22K ohm, 1/4W	04-002230	164,174,		
R123	27 ohm, 1/4 W	04-002700	184,185	.047 mfd, 50V	06-000106
R26	270 ohm, 1/4W	04-002710	C158	.047 mfd, 50V	06-000106
R53	2.7K ohm, 1/4W	04-002740	C207	1000 pf, 50V	06-000393
R70,125	27K ohm, 1/4W	04-002730	C205,206	.01 mfd, 50V	06-000046
R142	3.3 ohm, 1/4W	04-003340	C201,202,		
R40,41,45	33 ohm, 1/4W	04-003330	203,204	.047 mfd, 50V	06-000106
R25,39,46,					
105,121,132	330 ohm, 1/4W	04-003310			
R18,19,27,28,					
47,82,94,135,					
145,146,156,					
161	3.3K ohm, 1/4W	04-003340			
R21,95,98	33K ohm, 1/4W	04-003330			
R1,6,96	330K ohm, 1/4W	04-003303			
R8,71	3.9K ohm, 1/4W	04-003940			
R3	4.3K ohm, 1/4W	04-004340			
R38,54,160	47 ohm, 1/4W	04-004700			
R12,29,33	470 ohm, 1/4W	04-004710			
R7,52,65,67	4.7K ohm, 1/4W	04-004740			
R83,97,101,					
103	47K ohm, 1/4W	04-004730			
R59,138	56 ohm, 1/4W	04-005600			
R16,24	560 ohm, 1/4W	04-005610			
R9	5.6K ohm, 1/4W	04-005063			
R2	56K ohm, 1/4W	04-005630			
R63	560K ohm, 1/4W	04-005603			
R51,79,90,					
114,143	680 ohm, 1/4W	04-006810			
R5,74,144,					
157	6.8K ohm, 1/4W	04-006083			
R100,131	68K ohm, 1/4W	04-006830			
R10,11	82 ohm, 1/4W	04-008200			
R69,139	820 ohm, 1/4W	04-008210			
R106,122,124	8.2K ohm, 1/4W	04-008023			
R4,64	820K ohm, 1/4W	04-008213			
	<u>RESISTORS-M-OXIDE TYPE</u>			<u>CAPACITORS-ELECTROLYTIC TYPE</u>	
R153,154	120 ohm, 1/2W	04-991210	C96	10 mfd, 16V	00-132115
R151	150 ohm, 1/2W	04-991510	C109,C161,		
R152	18 ohm, 2W	04-991800	C166	100 mfd, 16V	00-132175
			C160	2200 mfd, 16V	00-132400
			C159	330 mfd, 16V	03-132540
			C115	33 uf, 6.3V	00-132500
			C138	47 uf, 6.3V	00-132620
			C163	22 uf, 16V	00-132300
			C141	33 uf, 10V	00-132505
			C149,C165	47 uf, 10V	00-132625
			C8,59,108,		
			125,150,142	10 uf, 16V	00-132115
			C145,154	33 uf, 16V	00-132510
			C156,162,169	47 uf, 16V	00-132630
			C93,144,148	3.3 uf, 25V	00-132465
			C121	4.7 uf, 25V	00-132600
			C12,30,69,		
			75,111,136,		
			137,143,146	1 uf, 50V	00-132055
			C65	4.7 uf, 50V	00-132610
			C168	33 uf, 16V	00-132510
				<u>CAPACITORS-MYLAR TYPE</u>	
			C117,210	0.01 mfd, 50V	03-000205
				<u>CAPACITORS-TANTALUM TYPE</u>	
			C153	4.7 mfd, 16V	03-003020
			C5,128,175	0.22 mfd, 35V	03-003030
			C8,81,107	0.47 mfd, 35V	03-003026
			C6,77,106	0.1 mfd, 35V	03-003035
				<u>CAPACITORS-TRIMMERS</u>	
			CT1,2,3,4,		
			5,6	Trimmer Cap. 10P, 50V	79-123004

IMPORTANT: FCC Data Number Must Be Supplied When Requesting Replacement
Parts And Service Information79-006

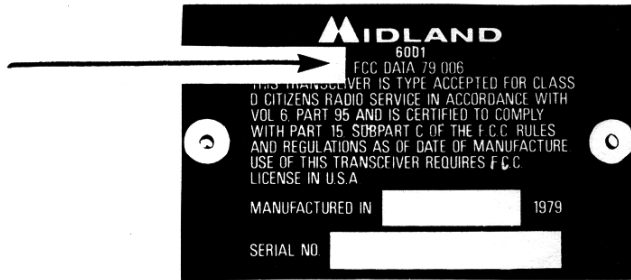

HOW AND WHERE TO ORDER REPLACEMENT PARTS

NOTE: To eliminate error and speed delivery of replacement parts, always include the following information on your order:

1. Complete identification of merchandise for which the part is wanted.
 - A. FCC Data Number
 - B. Model Number
 - C. Serial Number
2. Best possible identification of the part itself.
 - A. Part Number
 - B. Schematic Reference Number
 - C. Part Description
 - D. Quantity Requested
 - E. If necessary, return old part as sample.
3. Customer should use address listed below when ordering replacement parts.

MIDLAND
CUSTOMER SERVICE (PARTS DEPT.)
1690 NORTH TOPPING AVENUE
KANSAS CITY, MISSOURI 64120