

VOLUME 29

PUBLISHED SEPTEMBER 1990

# RADIO SECRETS®



FORMERLY  
SECRET  
CB

COPYRIGHTED

PRICE \$20.00 U.S. FUNDS

# ACKNOWLEDGEMENTS

---

*RADIO SECRETS wishes to gratefully acknowledge the following people for their help and contributions toward getting volume 29 in print. Their encouragement and contribution of material has been invaluable.*

*THANKS and a free book!*

<b>M</b> ARK WASSERMAN .....	6
<b>R</b> AY'S RADIO .....	6
<b>S</b> AM, T&S ELECTRONICS .....	7
<b>C</b> LARK R. KIRKLAND .....	8
<b>L</b> ESCOMM .....	16
<b>S</b> WEDE, ICHI-BAN COMMUNICATIONS .....	18
<b>B</b> ILL GRASSA .....	19
<b>J</b> ESUS S. PEREZ .....	23
<b>D</b> AVID LITTERER .....	23
<b>B</b> RONCO CB .....	24
<b>T</b> ERRY SHELLY .....	29
<b>T</b> ERRY DAVIS .....	29
<b>R</b> AY'S RADIO .....	34
<b>P</b> AT VIZENOR .....	34
<b>D</b> AVID C. COMPTON .....	37
<b>L</b> EE LAUFER .....	38
<b>B</b> ILL G. ....	40
<b>G</b> ENE S. ....	41
<b>A</b> LAN LAPE .....	41
<b>C</b> ARD KIT .....	43
<b>D</b> ON POWERS .....	73

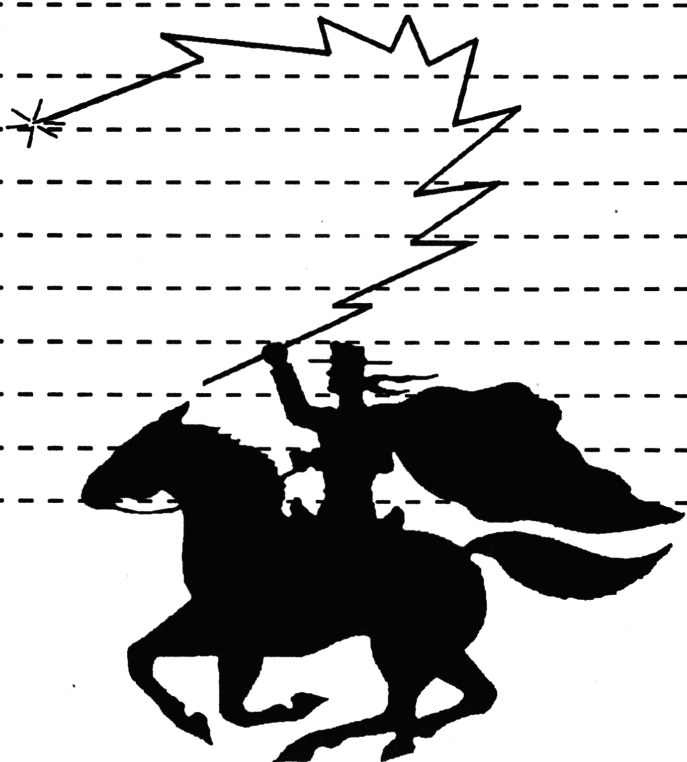

## INTRODUCTION

# **INTRODUCTION**

---

● by **DANE SELMAN**

Hello Everyone,

Welcome to RADIO SECRETS VOLUME 29, formerly known as SECRET CB. RADIO SECRETS VOLUME 29 enjoys more refinements to its new format established in VOLUME 28. Thank you Les, for helping make this project better each issue. This shop is celebrating our 14th anniversary and we are excited about the 1990's. "Thank you" to each and every contributor who helped make possible 29 editions of these manuals. To you experimenters who are inactive, come back to your workbench and equipment. To you working now, solving circuit problems, "keep up the good work!" Continue your improvements, innovations and experiments. Send all data reports detailed completely as possible including diagrams, which are very important supplements to procedure descriptions.

*Coming in Volume 30; RCI-2950 frequency mod, Realistic PRO-2005/6 scanner 800mhz mod, ICOM 735 & 751 general coverage freq mod, Kenwood TS140S general coverage freq mod, Super Star 121 HI/LO power mod and much more. DON'T MISS IT!!!*

Lets make the 1990's best ever. 'Til next time, "Have A Great Year!"

Regards,

A handwritten signature in cursive script that reads "Dane D. Selman". The signature is written in black ink and is positioned below the typed name "Dane D. Selman".

# TABLE OF CONTENTS

---

ACKNOWLEDGEMENTS . . . . .	1
INTRODUCTION . . . . .	2
TABLE OF CONTENTS . . . . .	3
EDITORS PAGE . . . . .	5
MAKE YOUR RIT WORK ON TRANSMIT, MOD-I . . . . .	6
RAY'S WAY RIT MOD, MOD-II . . . . .	6
ANOTHER RIT MOD FOR THE 2510, MOD-III . . . . .	7
HR2510 RIT SLIDE MOD, MOD-IV . . . . .	8
VARIABLE AM/FM POWER FOR THE HR2510 . . . . .	9
TALKBACK IN THE HR2510 . . . . .	10
ONE METHOD TO GET RID OF THE TALKBACK IN THE 2510, MOD-I . . . . .	11
UNIDEN HR2510 FEEDBACK FIX, MOD-II . . . . .	11
PRESIDENT HR2510 WITH UC1250 FREQUENCY MOD . . . . .	13
ABOUT THE HR2510 . . . . .	14
HR2510 POWER MIKE MOD'S . . . . .	15
INCREASING POWER OUT IN THE 2510 . . . . .	16
ANOTHER JACKSON FREQUENCY MOD. . . . .	18
INCREASED POWER OUT FOR THE JACKSON . . . . .	18
RCI-2900 ALIGNMENT PROCEDURE . . . . .	19
11 METER modification For RCI 2900 (NEW VERSION) . . . . .	23
CONNEX 3300 PUTTING THE PEEP BACK . . . . .	23
COURIER GALAXY V AND VI, 80 CH MOD . . . . .	24
120 CHANNEL MODIFICATION FOR THE COURIER GALAXY V AND VI . . . . .	26
EASY 10 METER VOICE CONVERSION FOR GALAXY II . . . . .	29
SUPER GALAXY ALIGNMENT PROCEDURES . . . . .	29
SUPERSTAR 3900 CLARIFIER MOD . . . . .	34
Super Star 3900 + 10 KHZ Frequency Shift. . . . .	34
Ranger AR 3500 Permanent battery back up . . . . .	35
Super Star 3900 28.300-28.500 . . . . .	35
CONVERTING THE UNIDEN PRO 810E WITH THE D.S.B. HF CONVERTER BOARD . . . . .	35
KIT #146 REVISED INSTRUCTIONS FOR REALISTIC TRC-453 . . . . .	37
IMPROVING THE KIT#106 . . . . .	38
<b>THE HAM RADIO SECTION</b> -----	<b>39</b>
THE ICOM 730 . . . . .	39
THE ICOM IC-725 MARS MOD . . . . .	39
THE ICOM IC-735 MARS MOD . . . . .	39
THE ICOM IC-751A GENERAL COVERAGE TX . . . . .	39
THE ICOM IC-765 MARS MOD . . . . .	40
THE KENWOOD TS-140 MARS MOD . . . . .	40

# TABLE OF CONTENTS

TS-140S 11MTR MOD . . . . .	.40
THE KENWOOD TS-930S GENERAL XMIT . . . . .	.40
THE KENWOOD TS-940S GENERAL XMIT . . . . .	.40
THE YAESU FT-747GX GENERAL XMIT . . . . .	.41
THE YAESU FT-757GX-II GENERAL XMIT . . . . .	.41
<b>TECHNOTES PART II</b> -----	<b>43</b>
TC SSB KIT IN THE COBRA 21,25 or 29 . . . . .	.43
APRIL TECH'S NOTES . . . . .	.44
THE TECH'S CHOICE DX (TC-DX) and the "D" kit. . . . .	.46
MODIFYING THE COBRA 148GTL Using The "D" Kit. . . . .	.48
Modifying the Cobra 21 & 25LTD, AR & AX-44/Uniden PC-66 . . . . .	.50
Select-A-Watt or Dial-A-Watt . . . . .	.56
The Circuit Of The Month . . . . .	.58
THE 29 IS BACK . . . . .	.61
Unit Evaluation, The UNIC RV-CB45 . . . . .	.62
AMC CIRCUIT . . . . .	.66
<b>SCANNER SECTION</b> -----	<b>70</b>
MODIFYING THE REALISTIC PRO-2004 . . . . .	.70
ON-OFF/VOLUME BEEP CONTROL FOR THE PRO-2004 . . . . .	.71
CELLULAR RESTORE FOR THE BC200/205XLT . . . . .	.72
MODIFYING THE BC760XLT (OLD VERSION) FOR CELLULAR . . . . .	.73
CELLULAR FOR THE NEW 760XLT AND THE REGENCY R1600 . . . . .	.74
<b>HINTS AND KINKS</b> -----	<b>75</b>
PRESIDENT JACKSON CRAPPY AUDIO . . . . .	.75
RCI-2900 SIDEBAND WARBLE AND SLOW FREQUENCY LOCK TIME . . . . .	.75
GALAXY II FREQUENCY COUNTER PROBLEM . . . . .	.76
Super Star 3900 FREQUENCY DRIFT . . . . .	.76
BAD AUDIO FROM BEARCAT 210XLT . . . . .	.76
<b>OPPS WE GOOFED!</b> -----	<b>33</b>

SORRY BUT NO INDEX IN THIS VOLUME. WE HOPE TO HAVE A COMPLETE REVISED INDEX IN VOLUME 30. REFER TO VOLUME 28 FOR LAST INDEX.

## EDITORS PAGE

---

Hi Friends,

We're back again with a another great issue. I'm sure you've all noticed that we have a new name. We're excited about that and also about what is happening in the world of radio. We're seeing a trend in the market. More and more CB's are being sold and they are being bought by the serious communicator. Not the 10-4 Good Buddies of the 70's. People are realizing how valuable CB radios can be for everyday communications. And for those of us who can't afford a Cellular Phone, the CB fills the gap nicely. We're also seeing a lot of people buying scanners, especially the ones with 800mhz! If you are in the market for a new scanner, be sure it covers 866-869mhz. This is the new police band for future licenses. You'll also find several useful scanner mods within these pages. And yes, Scanners are now available through Selman Enterprises. The good ones, like the Bearcat 760XLT and Regency R1600. Along with their Hand Held counterparts, the Bearcat 200XLT and Regency R4030. If you're interested, give Dane a call at Selman.

With all the activity, it makes me wonder where is all the material? In case you haven't noticed, volume 28 came out in march of '89. I've been chomping at the bit to get 29 out but haven't had enough mod info to make up a decent book. Help me out here guys. Send in that data! Please be thorough and neat when you do. Remember, I can't read your mind. Write down all the details. When you do a new mod, write it down, and send it in! And you guys with computers, (I know there's a bunch of you because I've gotten several mods that were done on a computer!) if it's a IBM/PC/MS-DOS compatible, just copy the appropriate files onto a floppy, (size or format does not matter) and mail me the floppy. Believe it or not, it only cost about \$.50 to mail one. And, if you request it, I'll copy the material onto another floppy and mail yours back! So as the TV commercial goes "You've got nothing to loose!"

I have received several nice comments about volume 28. Thanks for all of them. I'll try to keep up the quality that was passed along to me from previous issues. If you have ideas or comments about the format, please write and tell me. As you will see, some suggestions have been incoorporated into this volume.

Special Thanks to my wife Peggy and son Steven for all the encouragement and understanding!

To all my radio comrades, Thanks for the support!

73's  
  
Les

## **MAKE YOUR RIT WORK ON TRANSMIT, MOD-I**

# **MAKE YOUR RIT WORK ON TRANSMIT, MOD-I**

### **● MARK WASSERMAN**

- (1) Cut diode 150 located on main pc board.
- (2) Locate orange wire at top corner of RIT board, cut and hook up to pin 3 of IC107. This is the 3 pin transistor bolted to the left side of case next to VR116. You will have to make the orange longer to reach.
- (3) Hook it up to the lead that is closest to the back of the radio. You should now have +/- 5kc of slide.

## **RAY'S WAY RIT MOD, MOD-II**

### **● RAY'S RADIO**

- (1) Remove both covers.
- (2) Clip D150
- (3) Trace the orange wire from the clarifier back to the connector plug and cut it there.
- (4) Find the red wire (8 volts) on the mode switch board and solder the orange wire to it.
- (5) Set RIT to 12 o'clock, mode switch to AM, freq. to 28.000mhz.
- (6) Connect freq. counter to TP306. Adjust L315 for 6.200mhz.
- (7) Connect freq. counter to TP304. Adjust L318 for 38.695mhz.
- (8) Set mode switch to CW, connect freq. counter to TP1 and adjust L117 for 10.6950mhz.
- (9) Set mode sw. to LSB, adjust L118 for 10.6925mhz.
- (10) Set mode sw. to USB, adjust L116 for 10.6975mhz.
- (11) Check RIT range. Should be +/- 4khz.
- (12) Replace covers.

## ANOTHER RIT MOD FOR THE 2510, MOD-III

### OTHER HELPFUL HINTS

VR101 = S-MTR	VR111 = TXFREQ.
VR102 = SQUELCH RANGE	VR112 = FINALBIAS
VR103 = CWPOWER	VR113 = DRIVERBIAS
VR104 = ALC	VR114 = AMC
VR105 = FMDEVIATION	VR115 = MODMTR
VR106 = CARRIER BALANCE	VR116 = CWSIDETONE
VR107 = AMPPOWER	VR117 = RFMTR

## ANOTHER RIT MOD FOR THE 2510, MOD-III

### • SAM, T&S ELECTRONICS

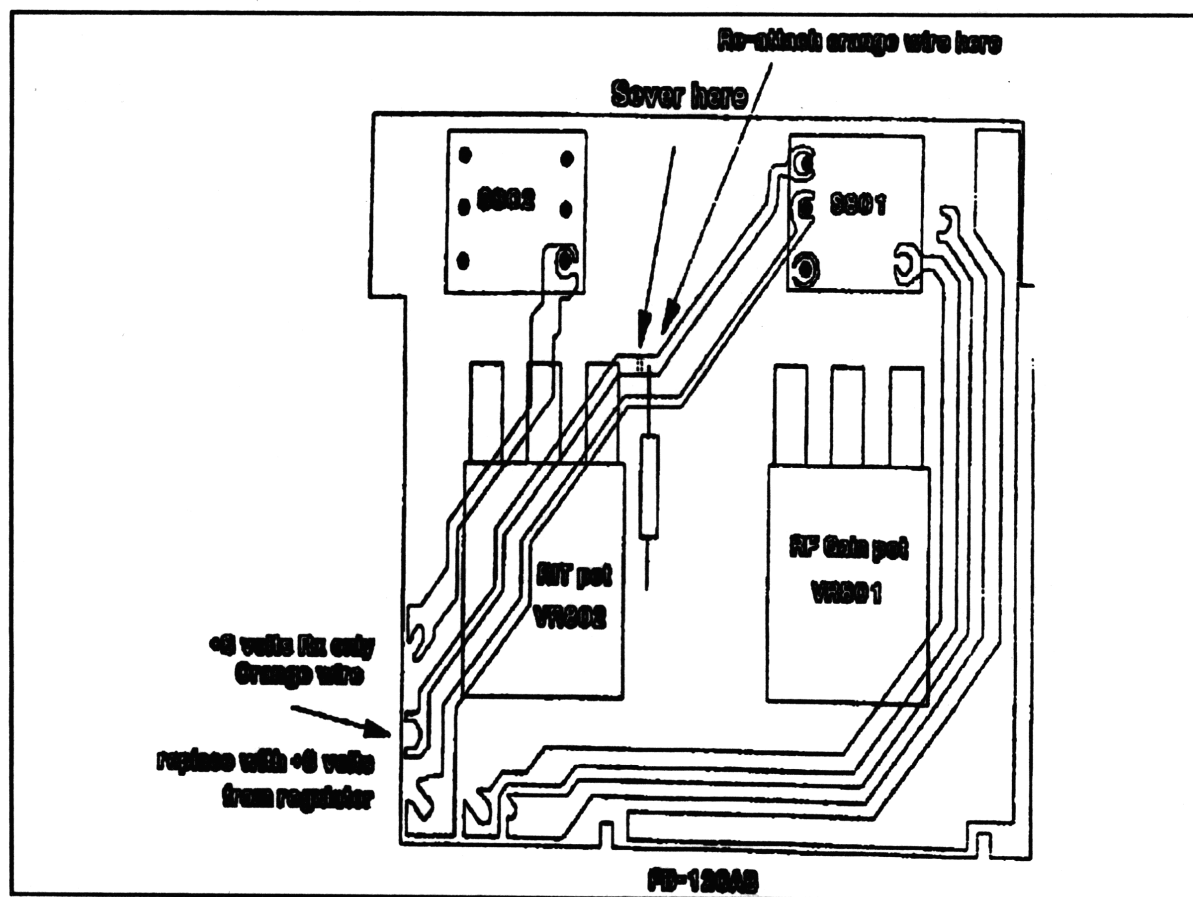

FIGURE #1 RIT MOD-III



## HR2510 RIT SLIDE MOD, MOD-IV

Refer to figure 1.

Remove top and bottom covers. Remove the four bolts that secure the pll board shield. Fold the pll board and shield up out of the way. Locate VR111 on the main board. Remove it and add it to your junk box. Find the small board that is home to the RF Gain pot and the clarifier pot. The third wire down from the top of the edge of the board should be orange. It brings 8 volts to the RF Gain and Clarifier (RIT) on receive only. Remove this wire and solder it to the other side of the trace cut in the diagram. Add a wire from the 8vdc regulator on top of the PLL board (7808) to where you removed the orange wire. Now you are feeding 8vdc to the fine tune and have RIT and XIT! No more TX/RX split and people saying "I can't understand you - you're off freq!! You should go back and touch up the three coils that center your USB, LSB and AM/FM/CW oscillators (L116,L117,L118) as per the manual. The factory doesn't have a frequency counter in the Philippines and the units are nowhere near specs in any HR2510 I have seen!

## HR2510 RIT SLIDE MOD, MOD-IV

### • CLARK R. KIRKLAND

(1) Remove Covers.

(2) Locate the orange wire on the circuit board, number PB120AB. Trace it to where it connects between the Rit Control, VR802 and resistor R-801, looking at the Rit board from inside Radio.

(3) Remove the orange wire from the circuit board and reconnect to resistor R-801. This connects

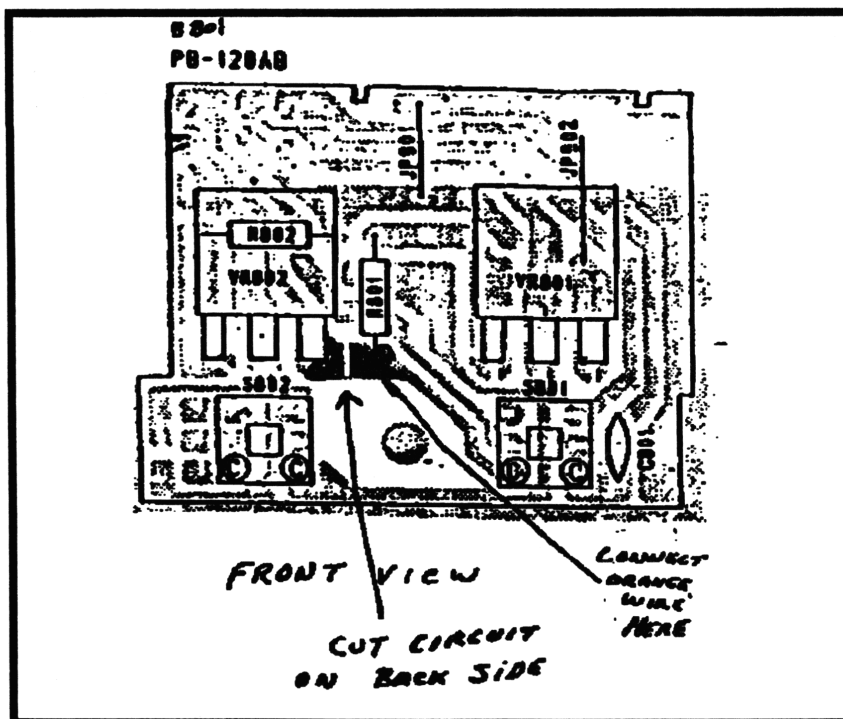

FIGURE#2 RIT MOD-IV

## VARIABLE AM/FM POWER FOR THE HR2510

the voltage back to the R. F. gain control.

(4) Next connect a 4" piece of hookup wire to where the orange wire, in step 2, was removed.

(5) Connect the other end of the hookup wire to R-75, closest to IC 105. This removes the TX frequency adjustment from the circuit

(6) To center the Rit Control, check at pin 16 of IC 301. Adjust L-315 for 10.2400mhz exactly, if needed.

Figure # 2 is a Front View. Connect Orange wire to R-801 side of cut run.

*NOTE: Be sure to CAREFULLY cut the circuit on the Back side!*

I think this will work on the Lincoln also.

## VARIABLE AM/FM POWER FOR THE HR2510

• MARK WASSERMAN

*NOTE:FOR THE EXPERIENCED TECHNICIAN ONLY.*

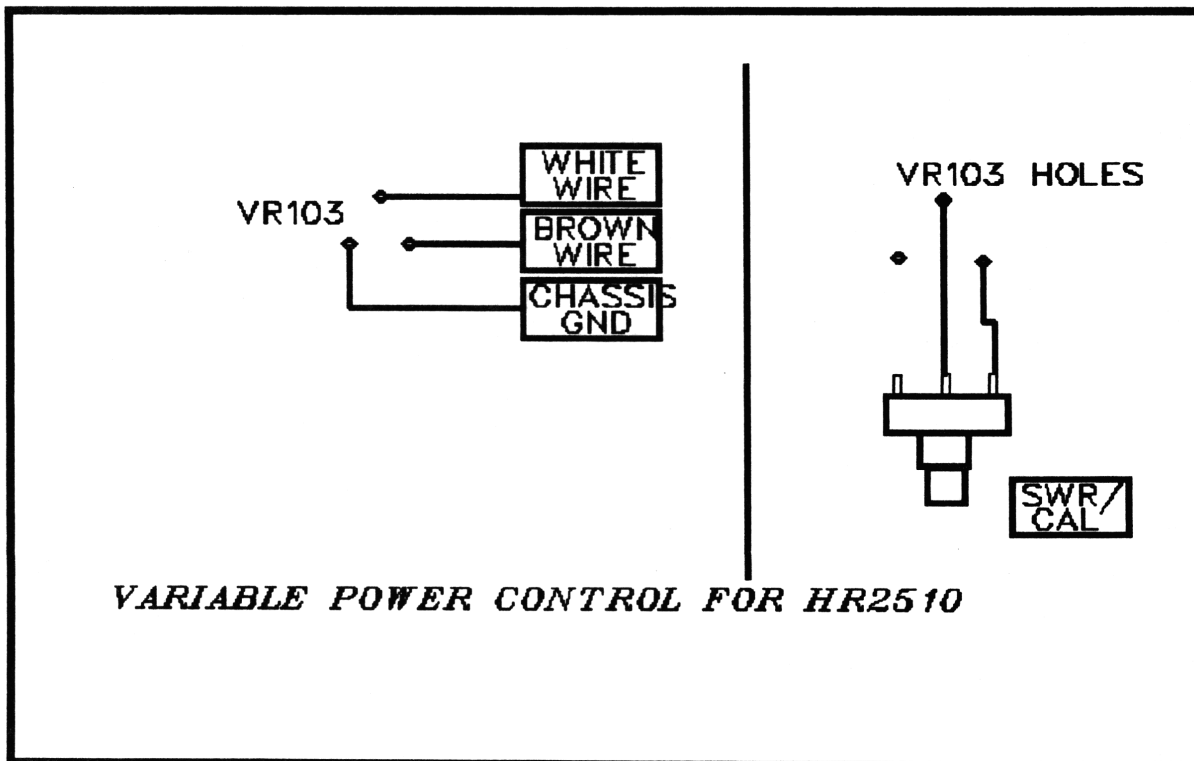

FIGURE#3..... VARIABLE POWER

## **TALKBACK IN THE HR2510**

This modification allows you to convert the SWR/CAL knob to function as a AM/FM carrier control without losing the ability to calibrate the SWR with the same knob.

- (1) Remove VR103.
- (2) Remove Brown and white wire from SWR/CAL knob PC board.
- (3) Cut PC trace on 3rd leg of board to separate it from ground.
- (4) Hook brown and white wires to VR103 and hook 3rd leg to ground.
- (5) Run 2 wires from VR103 holes to SWR/CAL knob, note VR103 holes, one is not hooked up to anything.
- (6) Transmit on AM or FM and adjust the SWR/CAL knob for about 3 or 4 watts on a watt meter hooked up to a dummy load.
- (7) Put your meter on the radio to the SWR calibrate position and adjust VR103 until it reads high enough to calibrate the meter.

## **TALKBACK IN THE HR2510**

---

Talkback is developed by enabling the speaker which is hooked up to the audio IC, alias the "modulator". The modulator will drive the speaker with audio so that you can hear how you sound over the air. This is a very nice feature for those who run echo. In most radios, the speaker ground lead is disconnected during transmit to prevent squeal or feedback. What we need to do in the 2510 is run a ground wire from the speaker to the mic plug to act as a switchable ground for the speaker during receive.

Remove the speaker side of the case and look at the back of the speaker, you will see the speaker wires going from the speaker to the PC board of the radio. They are marked on the speaker as plus (+) and (-). Remove the one marked minus (-) FROM THE PC BOARD. This will be your new switchable ground wire. Now locate the mic. jack in the front of the radio and find the two small chokes that have been added at the factory on the small PC board. These are on pins four and five and control the channel up and down buttons on the stock microphone. Remove the one on pin five at the pin. Insulate the end that is free with some heat shrinkable tubing. Now, you can take the speaker wire you have removed and solder the free end to pin five. Pin five now becomes the switchable ground pin.

## ONE METHOD TO GET RID OF THE TALKBACK IN THE 2510, MOD-I

A

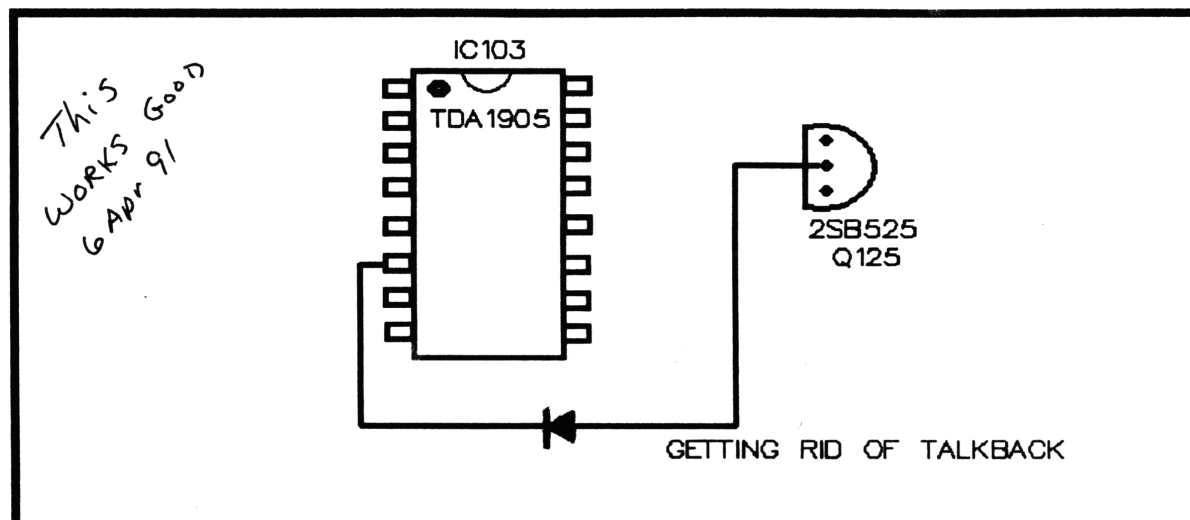

FIGURE# 4.....GETTING RID OF TALKBACK

## ONE METHOD TO GET RID OF THE TALKBACK IN THE 2510, MOD-I

---

### ● MARK WASSERMAN

To get rid of talkback in the HR2510, all you have to do is install on 1N914 silicon switching diode.

- (1) Hook the cathode to pin 6 of IC103.
- (2) Hook the anode to the center pin of transistor TR125. (This turns off the audio during transmit.)

These parts can be found on the left side of the radio toward the back. This modification has been used for one year with no problems. View is looking down from the top, front of radio toward you.

## UNIDEN HR2510 FEEDBACK FIX, MOD-II

---

### ● Sam T&S Electronics

When speaking loudly into the microphone or adding a power mike (the Cobra CA-71 is great for the price!) to the HR2510, the audio feedback is obnoxious! It seems that the audio amplifier chip, IC-103, a TDA 1905 is not quite switched over to the TX from RX when you key the mike. The fix is to rebias the switched

## UNIDEN HR2510 FEEDBACK FIX, MOD-II

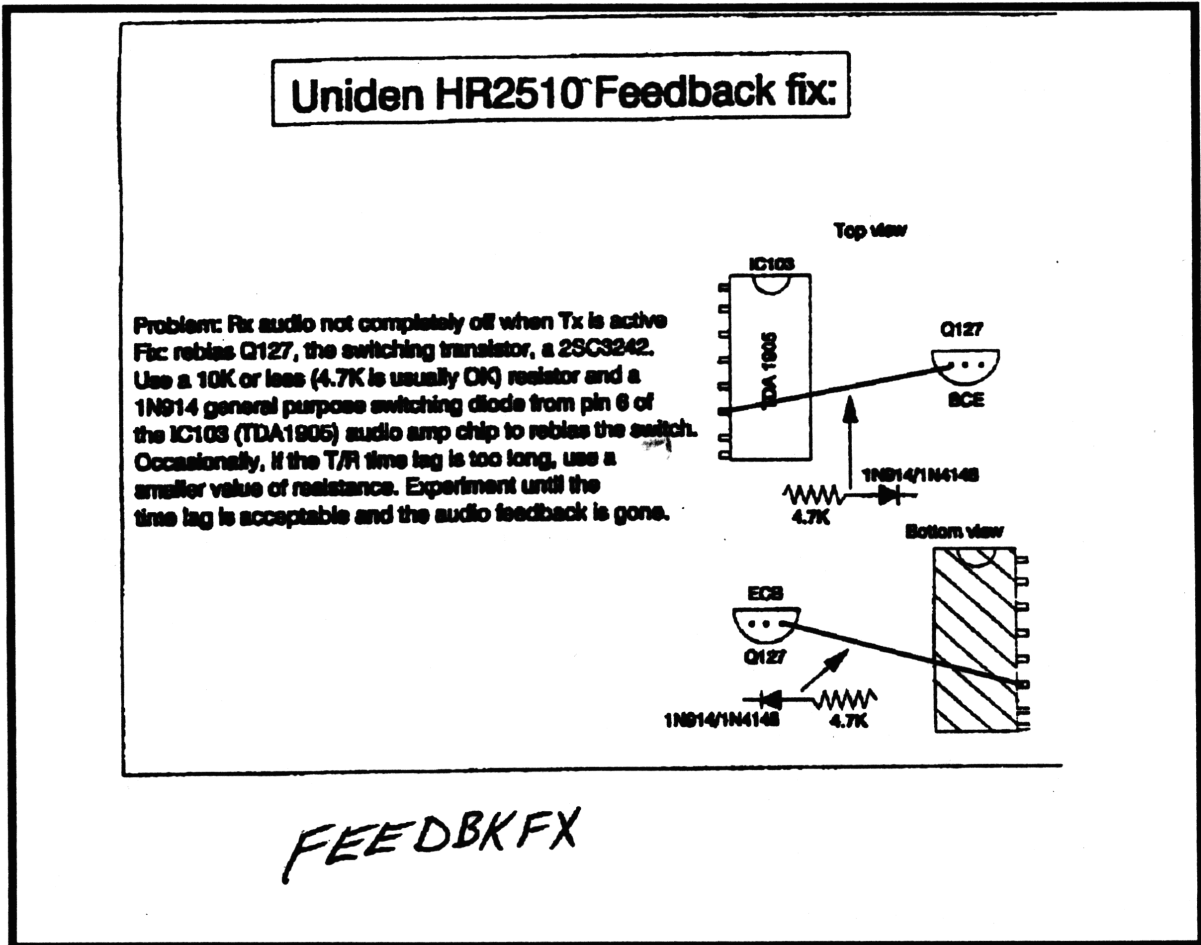

FIGURE#5.....FEED BACK FIX, MOD-II

transistor Q127 with a resistor and diode as per the accompanying diagram. Of course, as you will note from the lovely red-letter warning note packed with the units, any modifications to the unit voids your warranty and allows Uniden to turn

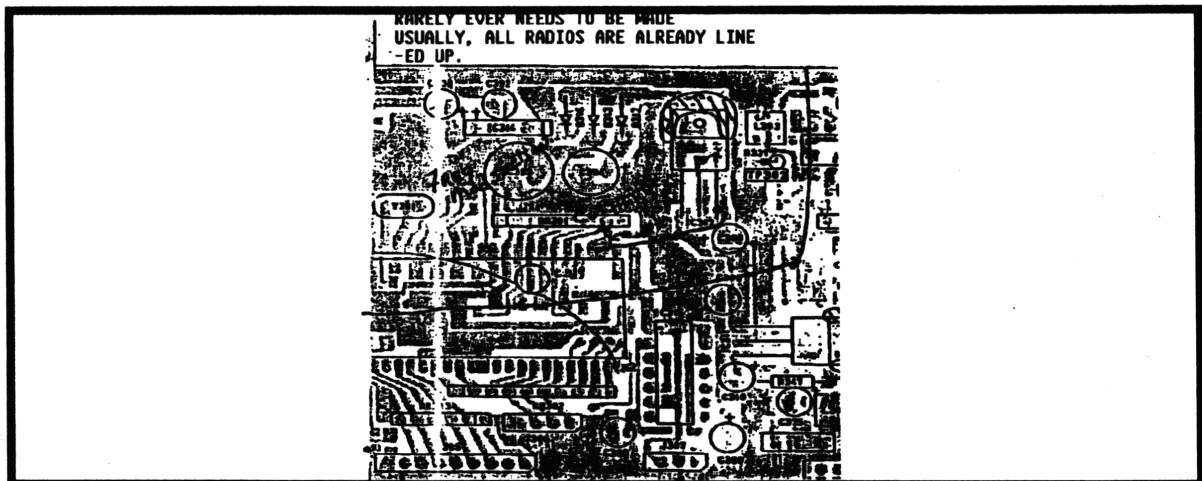

FIGURE#6.....UC1250 FREQ MOD

## PRESIDENT HR2510 WITH UC1250 FREQUENCY MOD

you into the FCC! Nice doing business with you, Uniden, you are such a nice company to deal with!

Problem: Rx audio not completely off when TX is active

Fix: rebias Q127, the switching transistor, a 2SC3242 Use a 10K or less (4.7K is usually OK) resistor and a 1N914 general purpose switching diode from pin 6 of the IC103 (TDA1905) audio amp chip to rebias the switch. Occasionally, if the T/R time lag is too long, use a smaller value of resistance. Experiment until the time lag is acceptable and the audio feedback is gone.

## PRESIDENT HR2510 WITH UC1250 FREQUENCY MOD

---

### • CLARK R. KIRKLAND

PLL: UNIDEN-UC1250

HR-2510 Freq Mod. Remove speaker side of radio and remove the board. The board is in a metal frame about 1/2 the size as main board. Turn board over and find pins 34-35 cut trace and add 15K resistor as before. Note JF radio has epoxy. Heat with 400 W. hair dryer. Pick off. The last one I did was soft. It came off easy with no heat.

Tune up.

ALC VR 104

AMC VR-114

### President Lincoln Freq mod.

Connect Pin 34-35 Together and that is it.

26.000-29.6999 some will go to 29.9999

Tune up same as HR-2510

*NOTE: All work done on back side of PB-160AB. Back side of PB-120AB is exposed inside of HR2510*

(1) Resistance values are shown in Ohms unless otherwise noted. (K = Kilohm; M = Megohm).

(2) Resistor wattages are 1/8W unless otherwise noted.

## **ABOUT THE HR2510**

(3) Capacitance values are indicated in micro farads unless otherwise noted.  
(uf = Microfarad)

## **ABOUT THE HR2510**

---

The 2510 has two main circuit boards. One is the PB121AB. This board contains a 5 volt regulator, an 8 volt regulator, and the microprocessor. The microprocessor is the UC1170 DIP (Dual In-line Package) chip and it controls the bandwidths, channels, frequency, redouts, etc. In effect, it controls the whole radio. The PB121BA also contains the PLL0305A, a serial PLL, which is fed directly by the microprocessor thus avoiding the pin jumping needed in older radios. Modification is performed by programming the pins on the microprocessor, allowing you to obtain the extra bandwidths you want. Two S042P mixer chips are also on this board. These are the same chips used on the 148GTL. They do the mixing in the VCO (Voltage Control Oscillator) and they make the VCO very stable.

The other main board, which is controlled by the microprocessor, is the PB111AB. The MR477 final, the 2166 driver and the AN612 balance modulator are located on this board. It also contains the complete audio, receive and transmit circuitry. The audio IC chip is a TDA1905, a full 7 watt IC DIP chip that is being used on all new Uniden radios, including scanners. It is somewhat unusual in that it is a 14-in chip rather than a flat pack, but it must work very well because Uniden has been using it for some time. The receive uses a 455KHzIF (Intermediate Frequency) which gives you a crystal filter for reception. The resulting narrower bandwidth causes better rejection and helps prevent bleedover. The AMC (Automatic Modulation Control) is handled by VR114. VR104 handles ALC (Automatic Level Control). When increased to max, it can develop 25 to 30 watts at peak. The AM power control is VR103.

The radio also contains several other smaller circuit boards that perform specific functions. The PB119A is the FM detector board and enables the radio to receive Frequency Modulation (FM).

## **HR2510 POWER MIKE MOD'S**

The PB117M is the noise blanker and AM detector board and it allows operation on the AM band. There are different boards because this is a basic Uniden chassis. It can be configured easily to suit any customers needs, such as the Realistic HTX100. (It has no LSB or AM.) To get the configuration desired, the appropriate board is plugged in and soldered into place.

The PB100AB is the collector current adjustment board. This board allows for the easy measurement and adjustment of the final transistors bias current. You can pull the board and put a current meter between each of the pins to set up the bias on the finals.

The PB118AA SWR board has the SWR meter circuitry on it. Information is sampled by this board and sent to the microprocessor. This board determines what you see on the front of the radio.

The PB112 is the digital readout board. It has a IR2429 IC chip on it which is the driver for the LCD display. It takes information from the microprocessor and feeds it to the display.

Those are the most important boards in the radio. There are several other subboards in the front of radio for volume control, modulation selector switches and the like.

## **HR2510 POWER MIKE MOD'S**

---

### **HR2510 MIKE WIRING**

**PIN 1 White Audio**

**PIN 2 Red and Shield**

**PIN 3 Blue**

**PIN 4 Not used**

**PIN 5 Not used**

Take off the speaker side of the case and expose the back of the speaker, you will see the speaker wires going from the speaker to the PC board of the radio. They are marked on the speaker as plus (+) and minus (-) FROM THE PC BOARD.



## **INCREASING POWER OUT IN THE 2510**

This will be your new ground-to-receive wire. Now locate the mic jack in the front of the radio and find the two small chokes that have been added at the factory on the small PC board. These are on pins four and five that control the channel up and down buttons on the stock microphone. You want to remove the one on pin five at the pin, taping shut the end that is freed. Now, you can take the speaker wire you have removed and solder the free end to pin five. Pin five now becomes the ground-to-receive pin. Once you have completed these modifications in the guts of the radio, you can now wire up a mic. The following example is for a D104 or other Astatic microphone. A Turner microphone would be wired in the same way EXCEPT you swap the red and blue wires.

**PIN 1:** the **WHITE** wire (audio)

**PIN 2:** the **BLUE** and **SHIELD** wires (command and ground)

**PIN 3:** the **RED** wire (ground to TX)

**PIN 4:** no connection

**PIN 5:** the **BLACK** wire (ground to RX)

Turner + 3B to HR-2510

**PIN 1:** **WHITE** (audio)

**PIN 2:** **RED** and **SHIELD**

**PIN 3:** **BLUE** (TX)

**PIN 4:** no connection

**PIN 5:** **BLACK** (RX)

Now the HR2510 should be quiet as a mouse!

## **INCREASING POWER OUT IN THE 2510**

### **● LESCOMM**

- (1) Remove top and bottom covers. Watch out for the speaker wires.
- (2) Refer to diagram. Locate and remove Q132 & 134.
- (3) Replace Q134 with an ECG340 or a TCG340. **WARNING!!!** The leads of the two transistors are exactly opposite of each other. See diagram.
- (4) Replace Q132 with an MRF497, and don't forget the heat sink compound!.

## INCREASING POWER OUT IN THE 2510

- (5) Remove C132. No replacement.
- (6) Remove C112 and C116.
- (7) Replace C112 with an 82pf cap, but place the new cap on the **bottom** of the board.
- (8) Replace C116 with a 100pf cap, but place this one on the bottom of the board also.
- (9) Reinstall the cover without the speaker with a couple of screws to hold it.

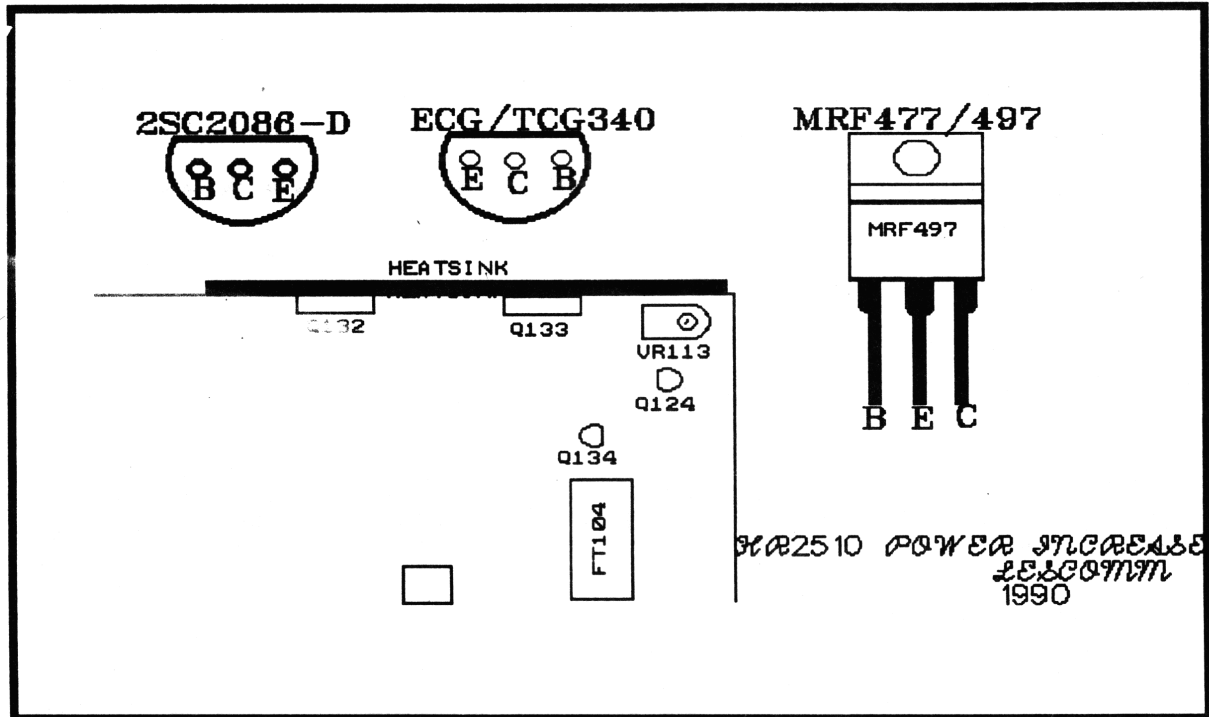

FIGURE# 7.....HR2510 POWER INCREASE

- (10) Connect power to the radio, and following alignment procedures, adjust the bias of Q132 to 80 +/-5 ma by adjusting VR112.
- (11) Inject a two tone signal into the microphone of the unit while transmitting into a dummy load. Set VR104 (ALC) for maximum output.
- (12) Again inject a 2 tone signal and transmit into a dummy load. Spread or contract coils L121, and L123 for highest power out in the center of the band.
- (13) Using a B&K power meter, yielded 52 watts PEP out at center of band.
- (14) Replace the other cover now after reconnecting speaker wires, and install all screws.

You'll notice that after all this transmitting and adjusting, the heat sink is just barely warm. One of the fringe benefits of this mod.

## **ANOTHER JACKSON FREQUENCY MOD.**

### **ANOTHER JACKSON FREQUENCY MOD.**

---

#### **• SAM, T&S ELECTRONICS**

Replace the 14.500 Mhz mixer crystal with one of 450 or 900 khz higher to move the bands up for the inclusion of the 10 meter novice/tech band. A 640 khz jump similar to the MB8719 PLL pin 10 jump will add frequencies above the given frequencies by powering up the 4008 adder IC#7, pin(3). This enables the addition of 20+ more frequencies without changing crystals.

When ordering crystals, don't forget to add 2 1/2 or 3 khz to allow you to even out the clarifier +/- 5 khz or better. If you take the Uniden crystals at face value (15.000 mhz) and add 450 or 900 khz, you will not be able to center the clarifier since the 15.000 mhz crystal Uniden supplies is really 15.0025 mhz.

15.0025 mhz will give you 26.515-28.755.

15.4525 mhz will give you 26.965-29.205.

### **INCREASED POWER OUT FOR THE JACKSON**

---

#### **• Swede, Echibon Communications**

Mod done on Blank Face Jackson, PB-042AB, with HI/LO Pwr mod, 5kc drop & Extended frequency range.

You will need an MRF497 and an ECG-340 before attempting mod.

(1) Replace the MRF477 with the MRF497. The 497 has a higher wattage rating (40watts RMS on the frequencies we are interested in) than the 477. The MRF497 itself doesn't give a power gain, but it runs cooler than the 477.

Test were done on 27.195 into a dummy load using USB w/ a 1000hz tone.

(2) After installing the MRF497, perform a trans alignment. Include the ALC and adjust to maximum. Set bias as outlined in alignment procedures. Adjust L43, L41, L42, L33 & L30, in that order. Power out on USB was 32 watts.

(3) Looking down past the driver, we find TR-38 (RF Pre driver a 2SC2086. Remove it and replace with an ECG-340.

## RCI-2900 ALIGNMENT PROCEDURE

*NOTE; the pinouts are exactly opposite-EBC vs CBE.*

Of course to make things easy, the tranny is under the RF Shield. Nobody said this was a get rich quick business.

The results after re-alignment was 42 actual watts! (Measurement was taken on a REAL watt meter). Admittedly not spectacular. Other chassis might produce better results.

The main value here is that after three minutes of solid dead key at 42 watts, the heat sink could still be touched. Not tested, but imagine how nice it would be if 15W AM/FM could be run for long periods without damage to the final!

*WARNING!!! Do not try to drive an amp with this radio after doing the mod.(Or before for that matter!)*

Presently, prices are running around \$28.00 for the set.(Including shipping)

## RCI-2900 ALIGNMENT PROCEDURE

### ● BILL GRASSA

#### PLL Adjustment

(1) Turn CLARIFIER in the middle position.

(2) Put test probe of counter on TP4, unit in 28.0000MHz (RX mode)

In AM, adjust L21 to read frequency 17.205MHz +/- 50Hz

In USB, adjust L22 to read frequency 17.3075MHz +/- 50Hz

In LSB, adjust L23 to read frequency 17.3025MHz +/- 50Hz

(3) Put test probe of multimeter on TP6, unit in TX mode

In AM, adjust L27 to read 10.695MHz +/- 30MHz

In USB, adjust L28 to read 10.6925MHz +/- 30MHz

In LSB, adjust L29 to read 10.6975MHz +/- 30MHz

(4) Put test probe of multimeter on TP7, unit in 28.0000MHz (RX mode)

In AM, adjust L17 to read DC 0.85V

(5) Put test probe of oscilloscope on TP5, unit in 28.0000MHz (RX mode)

In AM, adjust L18 to maximum output

(6) Unit in USB TX mode (MOD off)

Put current meter in TP3 and TP2 adjust VR11 to read 20mA on current meter

Put current meter in TP3 and TP1, first minimize with VR9 then adjust

VR10 to read 50mA and adjust VR9 to read 100mA

# RCI-2900 ALIGNMENT PROCEDURE

## RX adjustment

(1) Set unit in AM mode, squelch in MIN, RF GAIN fully clockwise, unit and RF SG select 28.0000MHz and 29.9999MHz (check two channels). Adjust L7, L8, L9, L10, L11, L12, L3, L20, L4, L5 to make maximum AF output. Input 6dB from RF SG the AF output must more than 2V, sensitivity must not be lower than 10dB

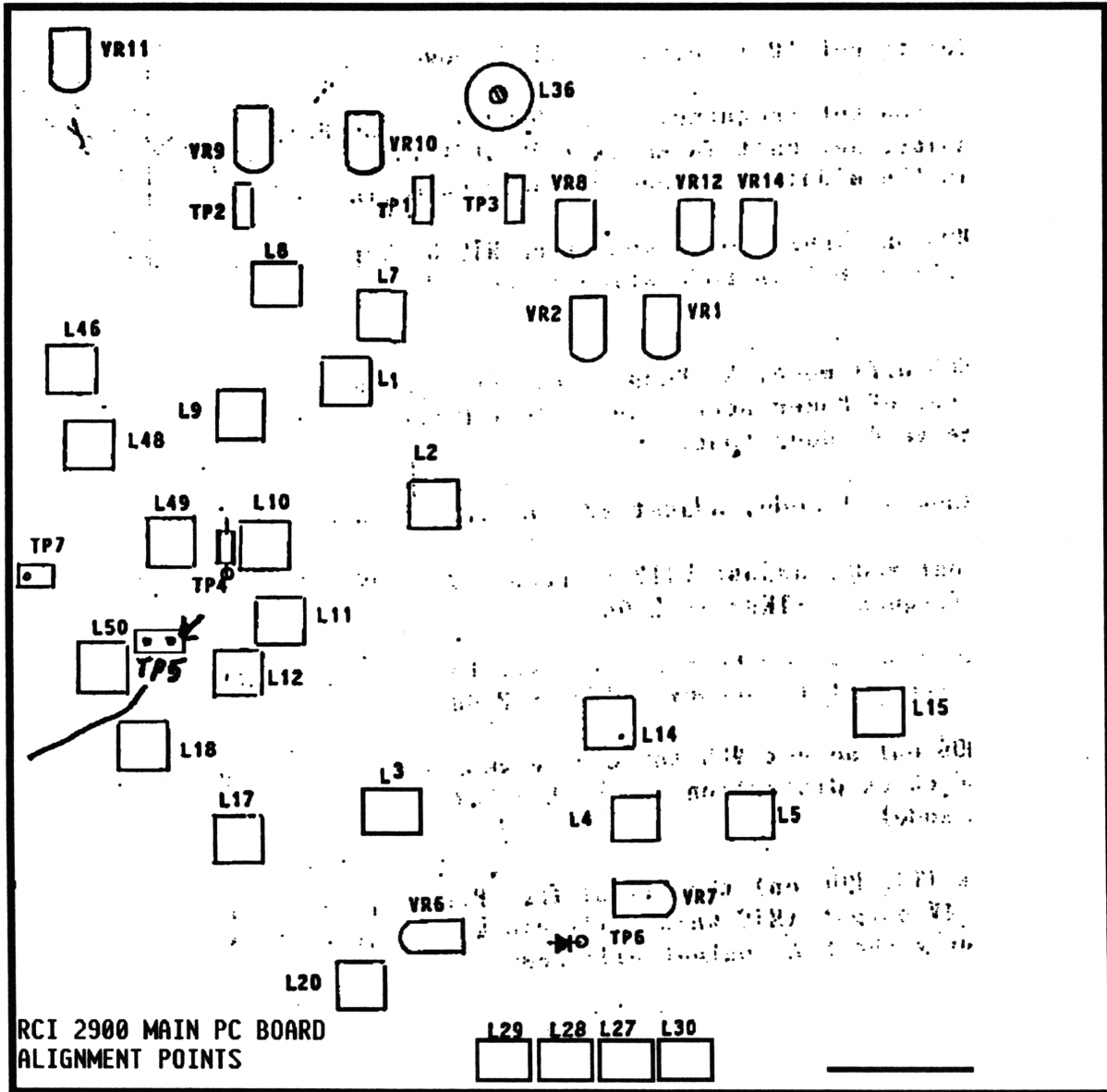

FIGURE#8.....RCI 2900 ALIGNMENT

S + N/N.

(2) Set RF SG in 60dB, when set AF output signal to 2V the distortion must not exceed 10%.

## RCI-2900 ALIGNMENT PROCEDURE

- (3) Set unit in FM mode RF SG in FM mode, adjust L6 to get maximum AF output, minimum distortion attenuate VOL to 2V output the distortion must not exceed 10%. In RF SG input 6dB the sensitivity must not lower than 20dB S + N/N.
- (4) Set unit in USB mode, RF SG and unit select the same channel. But set RF SG IN MOD off position and also frequency higher than unit for 1KHz. Input 6dB from RF SG adjust L14, L15 to get maximum AF output and signal output must more than 2V (set CLARIFIER in the middle position).
- (5) Set unit LSB mode, check procedure same as USB,

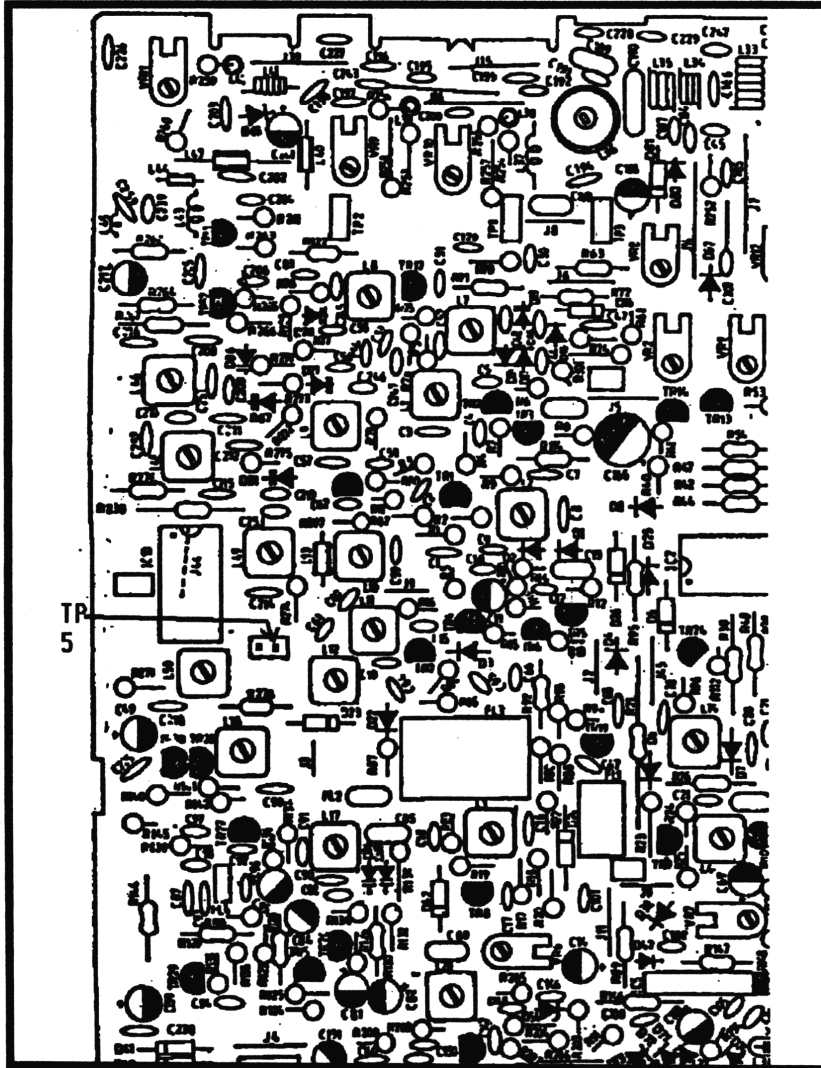

FIGURE# 9.....RCI 2900 ALIGNMENT LOCATIONS

28.000MHz USB mode LCD display S/Rf, set 45dB input in RF SG (SQ counter clockwise) adjust VR2 to read meter in "9". Fully clockwise SQ set 66dB in RF SG input adjust VR3 to AF just have output.

but set RF SG frequency lower 1KHz than unit frequency.

(6) Set unit in CW mode RF SG and unit select the same frequency in MOD off position input 6dB from SG to adjust L30 until no AF output.

(7) Set unit and RF SG in 28.000MHz USB mode LCD display S/Rf. set 45dB input in LCD select 45dB in RF SG output, adjust VR2 to read S/Rf meter in the middle of "9". Set SQ fully clockwise, set 66dB in RF SG adjust VR4 to AF just have output.

(8) Unit and RF SG select the same

## **RCI-2900 ALIGNMENT PROCEDURE**

(9) Set unit in 28.000MHz RF SG in 29.9999MHz input 66dB push keypad NB/ANL until LCD display NB/ANL. Use multimeter to test D2 cathode adjust L1, L2 to get maximum DC voltage.

### **TX ADJUSTMENT**

(1) Set unit in SM TX (MOD off) mode, push H/L key in H position the power HI LED will illuminate, adjust L36, L46, L48, L49, L50 to get stable and maximum power output between 28-29.999MHz. Then adjust VR13 to get all TX power within  $8W + (1)5W$ .

(2) Push H/L in L position to get  $1W \pm 0.5W$  in all TX power.

(3) Return H/L to HI position set frequency in 28.0000MHz, push METER keypad to have S/RF on LCD display. Set unit in AM TX (MOD off) mode, adjust VR8 to read RF line right in the middle (between red and green line) of S/RF meter.

(4) Set unit in AM TX (MOD on, 1KHz, 30mV) mode turn MIC GAIN full clockwise adjust VR14 to read 90%-100% in modulation meter and distortion must not exceed 10%.

(5) Set unit in AM TX (MOD off) mode, R. Beep ON position, then release PTT switch scope will have 0.5 sec of Roger Beep tone. Select R.Beep off set unit from TX to RX will no receive R. Beep tone.

(6) Set unit in USB TX (MOD OFF) mode, adjust VR7 to minimum carry power output .

(7) Set unit in TX (MOD on) mode, adjust VR12 to read 25W-30W in power meter and check transmit frequency  $+1KHz \pm 250Hz$ .

(8) Set unit in LSB TX (MOD on) mode check power meter to read 25W-30W for all frequency and check transmit frequency  $-1KHz \pm 250Hz$ .

(9) Set unit in FM TX (MOD on) adjust VR6 to read between  $\pm 2K - \pm 4KHz$  on modulation meter. And check that distortion is lower than 10% (Power output and frequency same as AM mode).

(10) Set unit in P.A. mode (TX, MOD on) the signal from P.A. mode (TX, MOD on) the signal from P.A. circuit, SPK should have more than 1KHz, 4V output (MIC GAIN fully clockwise) Turn the MIC GAIN counter clockwise slowly the P.A. output will reduce.

# **11 METER modification For RCI 2900 (NEW VERSION)**

---

● **Jesus S. Perez**

Behind of freq. display, Remove the white clear silicone, after this, Remove the soldering Point between two little legs, and clean them, keep seperated.

26000.0 to 29999.9

that's all

VR10-RF Meter VR12-ALC SSB

VR11-AMC or remove TR33 VR13-AM/FM Pwr.

Modification Pava e (RCI 2900 (Version Nveva)

11 METROS:

Detras DE/Display DE frecueucial, remveva el silieon Blauco traus pareute, Despues De Esto, desue/de dos pines que estan unidos, y limpie todo eontacto, mantengalo seprados

Cubrira ahora desde 26000.0 haita 29.999.9 Mh2

ES TODO

## **CONNEX 3300 PUTTING THE PEEP BACK**

---

● **David Litterer**

For those of you who don't know the CONNEX board, it is the same as the GALAXY, minus SSB, CW and PEEP. You can put the PEEP back in the radio by cleaning the holes out of positions marked for the following; R179, R180, R181, R182, R183, C136, C137, C138, C134,D83 TR33.

Parts you will need: 1 meg. 2.2k. 220k. 2-4.7k. 01uf (2).0047uf, 2.2uf 1N914 2SC945

STEP 1: Putting in all res.

**a.1meg.intoR179**

**b.2.2kintoR180**

**c.220kintoR181**

**d.4.7kintoR182**

**STEP2:ALLCAP**



## COURIER GALAXY V AND VI, 80 CH MOD

a.01ufintoC136

b.0047ufintoC137

c.0047ufintoC138

d.(2)2ufintoC134

STEP3:1N914INTOD82

STEP4:2SC945intoTR33

After you put all the parts in, solder a wire from J9 on the board to a 5 volt supply. add a switch in line with the wire, to make the peep switchable.

## COURIER GALAXY V AND VI, 80 CH MOD

### PLUS HALF CHANNEL MODIFICATION AND 10 KHz SLIDER

#### • BRONCO CB

This modification consist in isolating pin 20 of the PLL IC chip LC-7131 from the circuit and connecting a SPST switch from pin 20 to ground. This switch can be one of the existing switches located in the front panel (like TONE, HI -LO) or a separated switch mounted on the side of the unit. With the switch in the close circuit position, normal 'CB' operation and with the switch in the open circuit position, the unit will operate from 27.420 MHz.

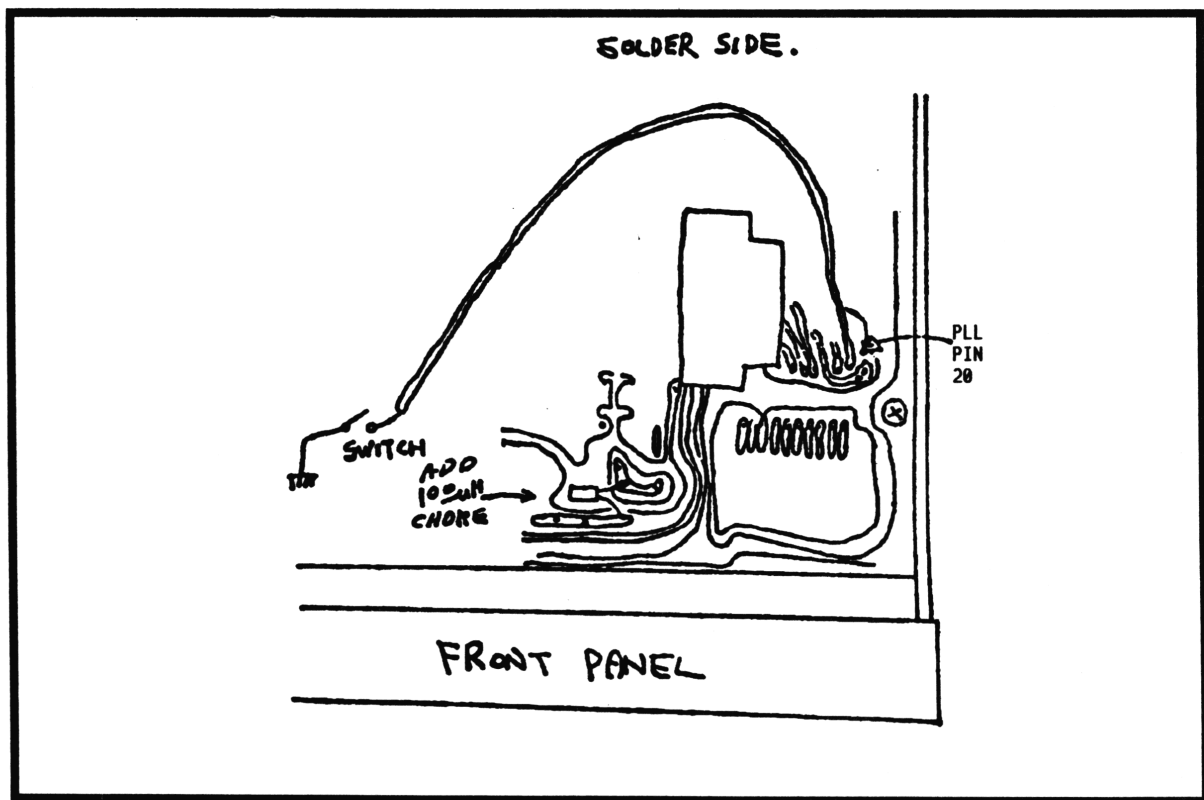

FIGURE# 10.....GALAXY V&VI 80 CH MOD

## COURIER GALAXY V AND VI, 80 CH MOD

- (1) Cut the "PCB" copper patten trace around PLL IC LC-7131 pin 20, isolating pin from the rest of the circuit.
- (2) Connect a SPST switch from PLL IC LC-7131 pin 20 to ground. The switch can be mounted on the side of the unit next to the PLL IC LC-713(1)
- (3) Check the operation of the unit of all channels. Check the transmitter power output on ALL BANDS, adjust coils L44, L43, L42, and L40 if necessary.

THE 80 CHANNELS MODIFICATION IS COMPLETED.

### CLARIFIER MODIFICATION FOR "10KHz" SLIDER

- (1) Cut top lead of resistors R501, R502, AND D75. (Located in the PCB near the front panel and next to coil L21).
- (2) Cut top lead of resistor R261 and solder a 4 inches long wire to the free end of the resistor R261, solder a 10 K (10,000 ohms) to the free end of the wire, then solder the free end fo the resistor to the 8 VDC PCB connection, located in the microphone preamplifier board attached to the side panel. (The 10K resistor is in series with the wire).

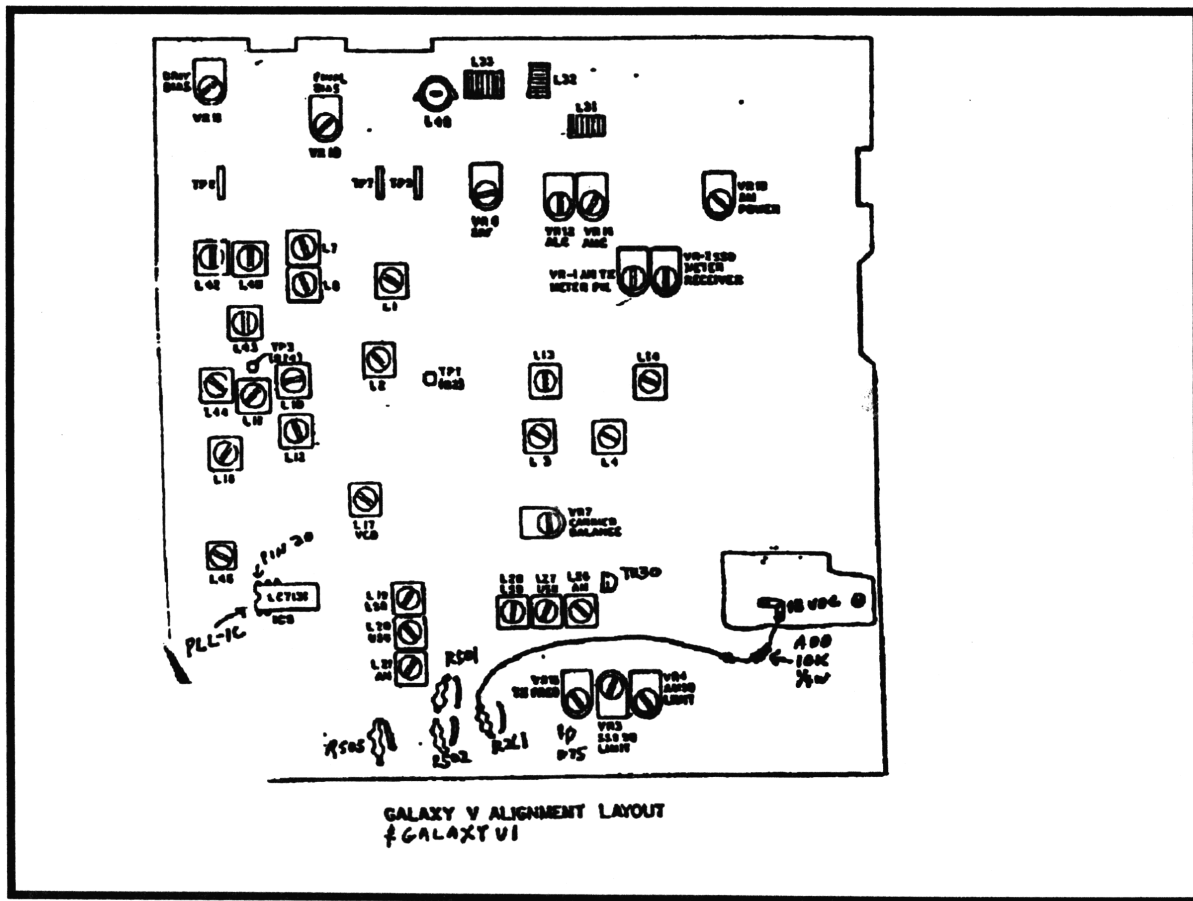

FIGURE# 11.....10KHZ SLIDER

## **120 CHANNEL MODIFICATION FOR THE COURIER GALAXY V AND VI**

(3) Solder a 100 microhenry choke across resistor R505 located next to the 10.24 MHz crystal.

THE CLARIFIER MODIFICATION IS COMPLETED

## **120 CHANNEL MODIFICATION FOR THE COURIER GALAXY V AND VI**

### **• BRONCO CB**

(1) This modification consist in mixing the 16 MHz "VCO" output with a 20 MHz crystal oscillator to obtain a new 37-38 Mhz receiver first conversion and transmitter mixer frequency.

(2) The "VCO" output line is open and the new mixer circuit is placed in series with the VCO output, converting the 16Mhz VCO output to the new 37-38 MHz frequency.

(3) Mount the modification PC BOARD switch on the side chassis close to the PLL CHIP.

(4) Locate the four holes, PCB connections between coils L18 and L44. Remove jumper wire connected from hole "B" to hole "D".

(5) Connect and solder the four wires from the modification board to the four pcb holes as follows:

A-RED WIRE TO HOLE "A"; B-BLUE WIRE TO HOLE "B"; C-BLACK WIRE TO HOLE "C"; D-YELLOW WIRE TO HOLE "D"

(6) Remove coils L29 and L30 located in front of coils L27 and L28 connect coil L30 from pin "A" to pin "D" and coil L29 from pins "c" to "D" and coil L29 from pins "C" to "B". (see drawing)

### **FREQUENCY COUNTER MODIFICATION FOR GALAXY VI ONLY.**

(7) Locate the shielded wire coming from the frequency counter module and connected to the main PCB, next to coil L46.

(8) Cut the PCB copper pattern trace connected to point "B" of the two pins "PCB" connector (This is connected to the center conductor of the shielded) and connect a jumper wire from the two pin connector hole "B" to hole "D" of the four hole "PCB" connections. (see drawing)

Locate the 4 pins connector, connected to the frequency counter module and reverse the "RED" and "WHITE" wires. If the "TRUE" USB or LSB is desired on

## 120 CHANNEL MODIFICATION FOR THE COURIER GALAXY V AND VI

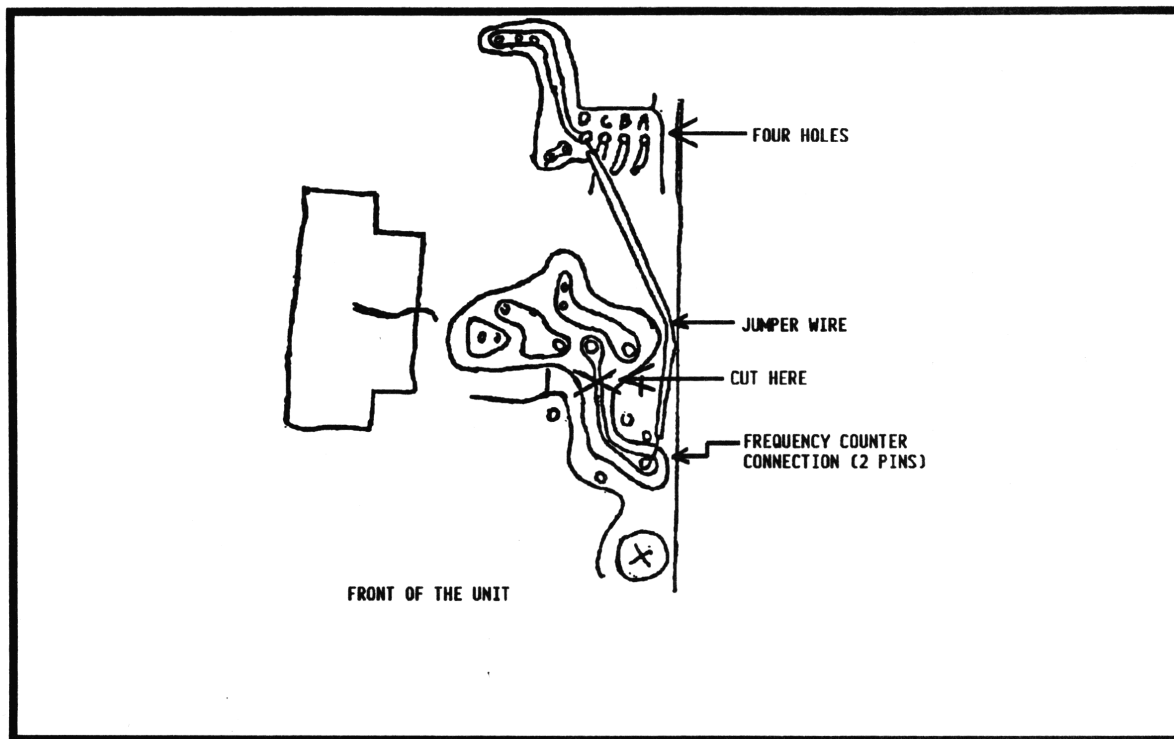

**FIGURE# 12.....GALAXY FREQ COUNTER MOD**

the display. Do not connect the RED or WHITE wires to the module. Tape wires ends.

### **TEST AND ALIGNMENT FOR GALAXY V AND GALAXY VI**

(9) Using a frequency counter with a low capacity probe, check the frequency of crystals located in the modification board. The frequency should be:

21.3900mhz. on "CB"

20.9400MHz. on "LO"

21.8400MHz. on "HI"

Output frequency can be obtained from pin 2 of the IC TA7310 located in the modification board. Adjust TRIMMER capacitors for proper frequency if necessary.

(10) Set the channel selector to channel 20 and using a 10 Megohms low capacity probe Voltmeter, connected to the PIN 17 OF THE PLL CHIP and adjust the "VCO" coil L17 to obtain 3 volts DC.

(11) With the channel selector set to channel 20 of the "CB MODE" adjust the coil located at the new "expander" board to maximum 37 - 38 MHZ "RF" output at the yellow wire. Check the complete operation of the unit.

## 120 CHANNEL MODIFICATION FOR THE COURIER GALAXY V AND VI

(12) Set channel selector to CH1, "CB BAND" AM. Check the frequency at the output of yellow wire. Frequency should be:

37.66000MHZ at CH1

38.10000MHz. at CH40

Adjust trimmer at modification board if necessary.

(13) Set "BAND" selector switch to "HI" mode and check the frequency at the output of yellow wire. Frequency should be:

38.11000MHz. at CH1

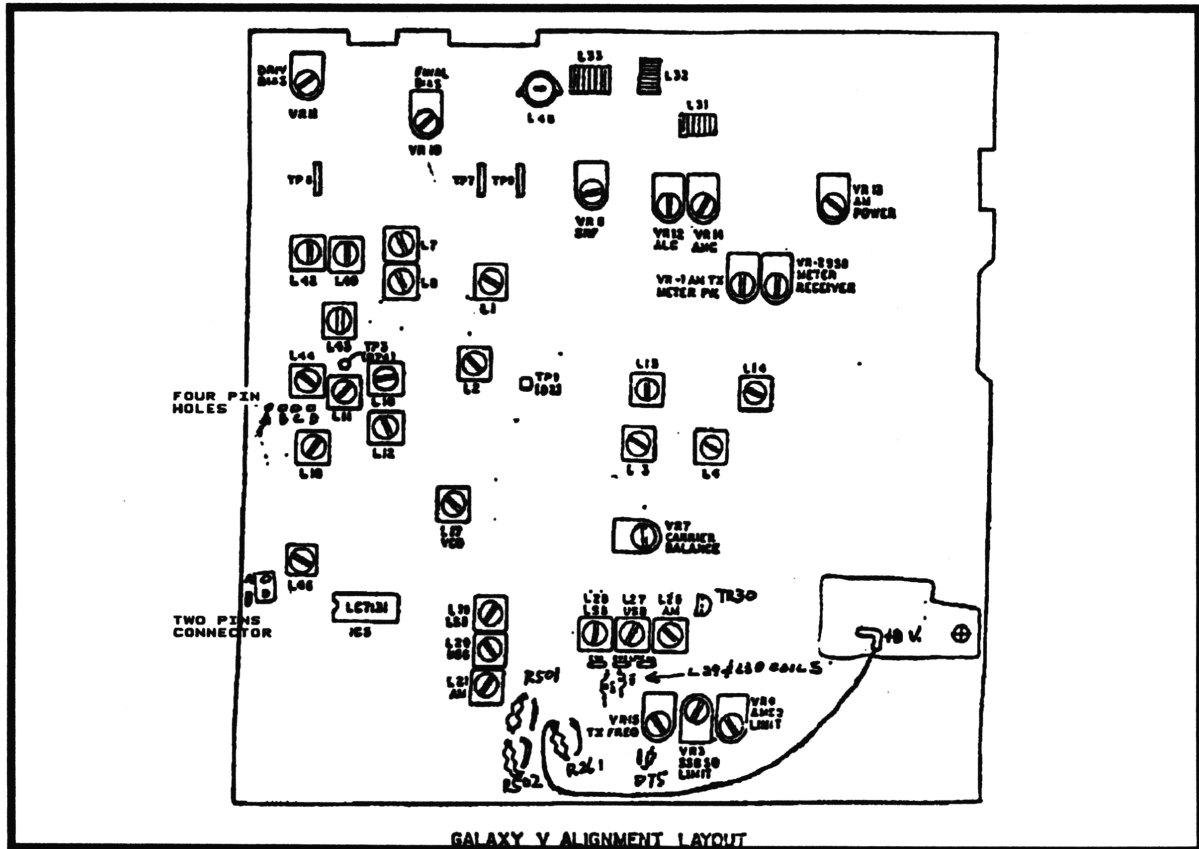

FIGURE# 13.....GALAXY V&VI

38.55000Mhz. AT CH40

adjust trimmer at modification board if necessary.

(14) Set "band" selector switch to "LO" mode and check the frequency at the output of yellow wire. Frequency should be:

37.21000MHz. at CH1

37.65000MHz. at CH40

(15) Check the operation of the unit.

## EASY 10 METER VOICE CONVERSION FOR GALAXY II

(16) Check transmitter power output on ALL BANDS, ADJUST COILS L44, L43, L42, AND L40 if necessary.

(17) Connect frequency counter to pin 11 of the PLL CHIP and Check the frequency. On receive mode the Frequency should be:

10.2380MHz. for "LSB" (L19)

10.24000MHz. for "AM" (L21)

10.24155MHz. for "USB" (L20)

Adjust coils for the proper frequency if required.

(18). Connect the frequency counter to the emitter of TR30 and check the frequency. In transmit mode the Frequency should be:

10.69250MHz. for "LSB" (L27)

10.69500MHz. for "AM" (L26)

10.69750MHz. for "USB" (L28)

(19) Check full operation of the receiver and transmitter.

THE 120 CHANNELS MODIFICATION IS COMPLETED.

### CLARIFIER MODIFICATION FOR "10KHz" SLIDER

(1) Remove or cut R501, R502 and D75. (Located in the PCB near the front panel and next to coil L21)

(2) Cut lead on top of resistor R261 and solder a 4 inch long wire to the free end of the resistor, then connect the free end of the wire to the 8 VDC PCB connection located in the microphone preamplifier board attached to the side panel.

THE CLARIFIER MODIFICATION IS COMPLETE

## EASY 10 METER VOICE CONVERSION FOR GALAXY II

### ● Terry Shelly

A switch between Pin 15 and 16 of 1C7 Bit adder will give 28.245 through 28.685 on "C" Band.

## SUPER GALAXY ALIGNMENT PROCEDURES

### ● TERRY DAVIS

*NOTE: Before any alignment all test equipment and radio are to be warmed-up for at least 30 minutes.*

# SUPER GALAXY ALIGNMENT PROCEDURES

## PLL SYNTHESIZER ALIGNMENT

Required test equipment

- (A). 0-5 Mhz oscilloscope.
- (B) Digital DC Voltmeter, 25mv sensitivity.
- (C) Frequency counter, 0-30 MHz.

(1) RX Mode, AM. Clarifier controls at center detent. Mid Band, Ch. 19. Connect Scope to TP-4 (top bare lead of R107). Adjust L16 for max. (0.9Vpp typical).

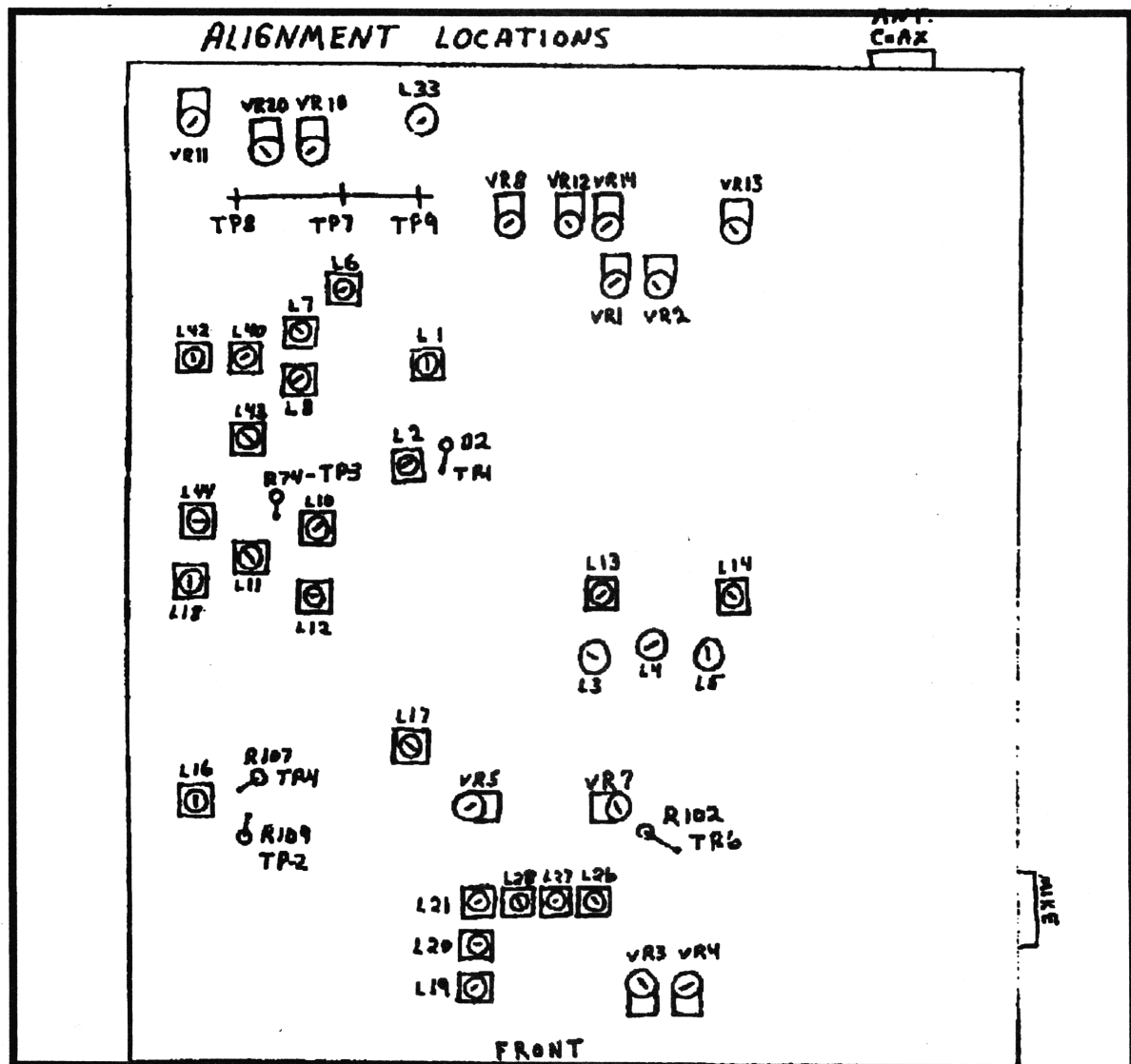

FIGURE# 14.....SUPER GALAXY ALIGNMENT LOCATOR

## **SUPER GALAXY ALIGNMENT PROCEDURES**

(2) Switch to Ch. 40. Connect DC Voltmeter to TP-2 (top bare lead of R109). adjust L17 for 5.40 VDC.

(3) Connect Scope to TP-3 (top bare lead of R74). Adjust L18 for max. (1.0vpp typical).

(4) Return to ch19 remove Scope from TP-3 and attach Frequency Counter to this point now. AM: Adjust L19 for 16.4900 MHz. USB: Adjust L20 for 16.4925 MHz. LSB: Adjust L21 for 16.4875 MHz.

(5) Carrier Oscillator Offsets: For AM, it will not be possible to read the 10.695 Mhz signal directly as it is with USB or LSB. Therefore the easiest AM adjustment will be to tune the appropriate AM coil (L26) in the TX mode for exact center channel frequency. Ch. 19. C Band. If the 16 MHz adjustment of step 4 was Properly made, the AM offset will automatically be 10.695 MHz as required. For USB and LSB, the adjustment can be made in the RX mode.

USB: Connect Freq. Counter to TP-6 (bare top lead of R102). Adjust L27 for 10.6925 MHz.

LSB: Adjust L28 for 10.6975 MHz.

AM: TX Mode. Adjust L26 for 27.1850 MHz.

**END OF PLL SYNTHESIZER ALIGNMENT.**

### **TRANSMITTER ALIGNMENT**

Required test equipment

(A) RF Wattmeter.

(B) 50-ohm dummy load 20 watts minimum power rating

(C) Frequency Counter, 0-30 MHz.

(D). Oscilloscope, 30 Mhz minimum bandwidth.

(E) Audio oscillator and two-tone generator.

(F) DC Voltmeter or multimeter with DC Amps capability.

(G) Spectrum Analyzer.

(H) FM Deviation Meter.

(1) Clarifier controls at center detent. C Band, Ch. 19. USB: TX Mode, Mike Gain Minimum. Remove Jumper PCB connecting TP-7,8,9. Connect DC Ammeter between TP-9 (+) and TP-8 (-).



## **SUPER GALAXY ALIGNMENT PROCEDURES**

Driver Bias: Adjust VR11 for 50ma. Move TP-8 jumper to TP-7 terminal. Final Bias: Unsolder Emitter lead of TR56; adjust VR10 for 25ma. Restore TR56 and unsolder lead of TR43; adjust VR20 for 25ma.

Restore TR43 Emitter.

Restore Shorting PCB Jumper Before Proceeding.

(2) Mike Gain at Maximum, Inject 50mv, two-tone audio signal at mike socket. Adjust L43, L44, L42, L40, L33 for maximum RF output as shown on Scope or wattmeter.

(3) Remove injected audio signal. Turn MIKE GAIN to minimum. Carrier Balance: Adjust VR7 for min. carrier leak through; recheck for LSB mode.

(4) MIKE GAIN at Max. Inject 100mv, two-tone audio signal at mike socket. SSB ALC; Adjust VR12 PEP.

(5) AM Mode, Mike Gain at Min. AM Carrier Power; Adjust VR13 for 10 watts power output.

(6) RF Meter: Adjust VR8 so meter agrees with actual wattmeter.

(7) MIKE GAIN at max. Inject 100mv, single-tone audio signal at mike socket. AMC: Adjust VR14 for 95% modulation.

(8) Switch to FM Mode, MIKE GAIN Max. Inject a single tone audio, 1 KHz @ 20mv into mike jack. FM Deviation: Adjust VR5 for Max. Deviation of 5 KHz.

(9) USE SPECTRUM ANALYZER TO CHECK FOR SPURIOUS EMISSIONS.

END OF TRANSMITTER ALIGNMENT.

## **RECEIVER ALIGNMENT**

Required test equipment

(A) Signal Generator with 27 MHz capability. Must have adjustable Modulation% and calibrated output steps.

(B) AF VTVM (5v full scale range) or oscilloscope

(C) 8-ohm audio load.

(D) DC Voltmeter

(E) FM Signal Generator

(1) C Band, CH. 19. Clarifier controls at center detent. RF Gain full on. SQUELCH OFF. Noise Blanker OFF. Set signal generator for 27.185 MHz. Signal of luv, 30% modulation, 1 KHz.

## SUPER GALAXY ALIGNMENT PROCEDURES

Adjust L4, L3, L12, L11, L10, L8, L7, L6 for Max. reading on AF VTVM, SCOPE, or radio S-Meter.

(2) USB: Remove modulation from Signal Generator, Use Clarifier as required to center signal meter reading. Adjust L13, L14 for Max. as in step (1)

(3) Increase Generator output to 100uv, UNmodulated. SSB S-Meter: Adjust VR2 for S-9 Reading.

(4) Increase Generator output to 1000uv. Squelch fully CLOCKwise. SSB Squelch Range: Adjust VR3 so that squelch just breaks.

(5) AM mode: Set Clarifier at center detent. AM/FM Squelch Range: Adjust VR4 so that squelch just breaks.

(6) Reduce Generator output to 100uv, Squelch fully Counterclockwise. AM/FM S-Meter: Adjust VR1 for S-9 reading.

(7) FM Mode: Reduce Volume as Required. Inject modulated FM signal of 100uv, 1 Khz tone. 5 KHz deviation. FM Quadrature Coil: Adjust L5 for max. audio with Scope on IC2 Pin 7.

(8) AM Mode. Set AM Signal Generator for 1uv UNmodulated. Turn on Noise Blanker: Adjust L1, L2 for maximum DC Voltage as measured at TP-1 (- of D2).

END OF RECEIVER ALIGNMENT

## OPPS WE GOOFED!

VOLUME 28 , page 22;

was: Brite/dim Button in....

Brite/dim Button in....

Should be: Brite/dim Button in....

Brite/dim Button out....

VOLUME 28, page 23;

Should have included crystals as shown in this corrected diagram.

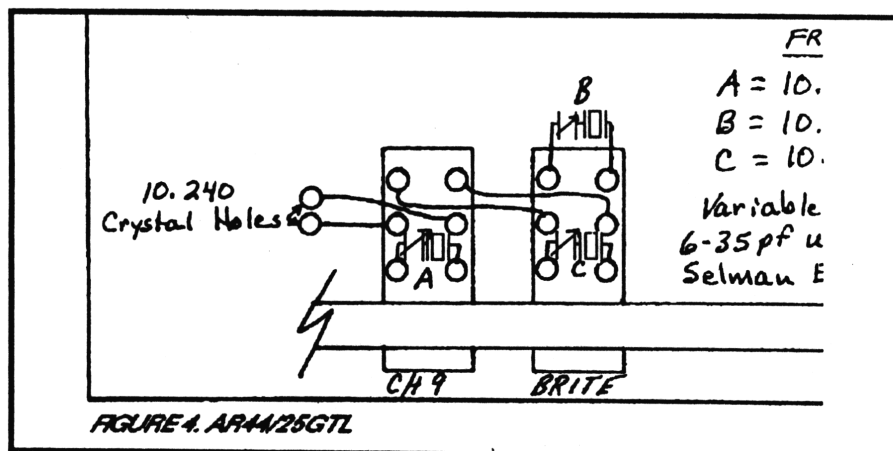

FIGURE# 37.....25GTL/AR44 LO/HI MOD CORRECTION

## SUPERSTAR 3900 CLARIFIER MOD

### ● RAY'S RADIO

- (1) Remove D75. (use board layout Vol. 22 Pg. 31)
- (2) Move green wire from spot 54 to an 9 volt. source. (spot 14 or 41)
- (3) Align synthesizer. (Vol. 22 Pg. 28)
- (4) The fine clarifier will now shift on transmit.

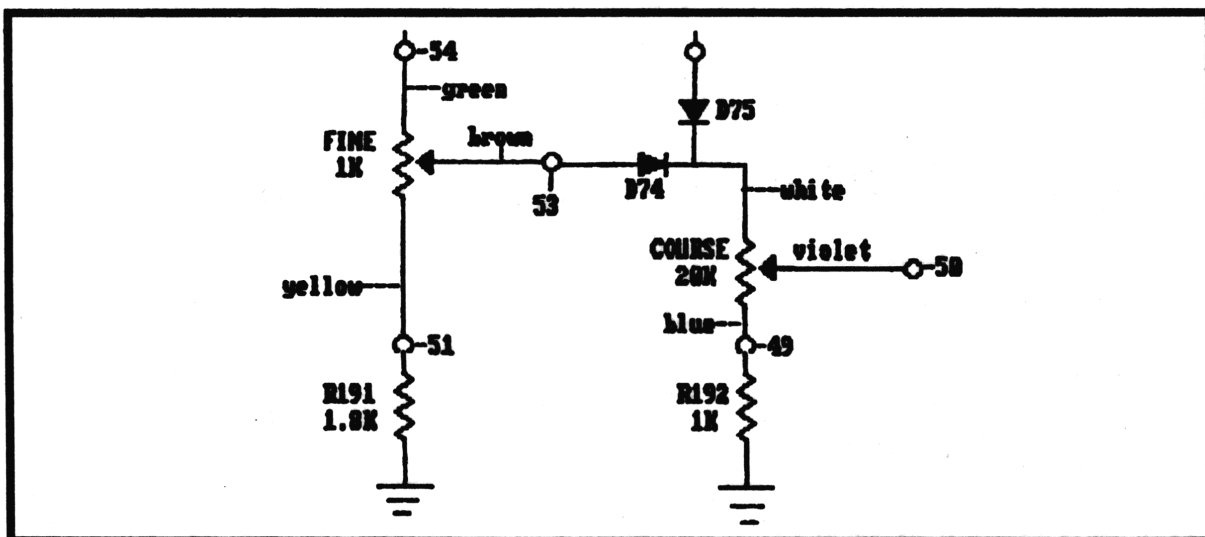

FIGURE# 15.....SUPERSTAR 3900 CLARIFIER MOD

## Super Star 3900 + 10 KHZ Frequency Shift.

### ● Pat Vizenor

- (1) Remove J49 & replace with 4.7k res.
- (2) Use a SPST Switch wire the center contact to a good 8V source. (3) Wire the top contact to pin 9 of 1C6.

### Clarifer fine slide for super star 3900

- (1) Remove D75 located near front of radio.
- (2) Locate Green wire on fine tune portion of clarifier pot. Remove at PCB resolder to 8VDC (front edge of PCB).

## **Ranger AR 3500 Permanent battery back up**

(3) Locate Yellow wire on fine tune portion of Clarifier POT. Remove at PCB. Resolder to good board ground.

## **Ranger AR 3500 Permanent battery back up**

● **Pat Vizenor**

Parts needed

- (1) 1N4001 Diode (or equivalent).
- (2) 1 AC Adapter (Radio Shack Cat. No. 273-1552)
- (3) Negative wire to Board Ground positive wire the Anode of the 1N4001 Diode connect Cathode to point "E" as indicated

## **Super Star 3900 28.300-28.500**

● **TERRY SHELLY**

Bit Adder IC7 MC14008BCP

Switch between pins 13 and 12 will give 28.300 to 28.500 on high "D" band, set frequencies to slide ahead to get RC Channels or use 10K jump in volume 22. Radio is broad banded and very little tuning is necessary.

## **CONVERTING THE UNIDEN PRO 810E WITH THE D.S.B. HF CONVERTER BOARD**

● **MARK WASSERMAN**

- (1) Remove C67 (the unmarked cap located between L38 and the PLL chip)
- (2) Replace D19 (located lower left side of L130 with super slide diode.
- (3) Connect red wire of D.S.B. to pin 11 of PLL chip.
- (4) Connect black wire to ground.
- (5) Connect blue wire to the side of C67 going to pin 10 of PLL chip.
- (6) Connect yellow wire to the side of C67 going to L38.

## **CONVERTING THE UNIDEN PRO 810E WITH THE D.S.B. HF CONVERTER BOARD**

(7) Place radio on ch(1) with switch in either position and key radio.while adjusting L38 until 27.285 or 27.605 displays on counter.

(8) Place switch to opposite position and place radio on ch 40. With radio keyed adjust vco until 27.725 or 28.045 displays on counter.

Be sure to check channels 1-40 with switch in all positions for proper vco setting.

(9) Adjust coils L34, L35, L36. L37. And L26 so power level is even across entire frequency range of the kit

VR1 = "s" meter

VR2 = squelch

VR3 = tx freq.

VR4 = carrier balance

VR5. = amc

VR6. = .alc

VR7. = "rf" meter

VR8. = final

VR9. = driver bias

VR10. = am power

*NOTE\*\*\*\*parts layout is identical to PC122 in SCB Vol.24 pg.20*

### **CLARIFIER MODIFICATION:**

(1) Remove covers an lay radio upside down

(2) Remove 2 side screws and 3 bottom screws that hold the front panel on.

(3) Lean front panel towards you and locate the clarifier pot.

(4) Cut both outside traces of the clarifier from the pc board

(5) Solder a jumper from the ground side of the meter-movement to the side of the clarifier closest to the top of the radio.

(6) Solder a jumper from the other side of the clarifier to jp17 (8 volts) Located to the left of the voltage regulator.

(7) Replace all screws to the front panel.

(8) Remove D25 & R119.

(9) Replace D23 with Super Slide diode.

(10) Retune coils L15-AM, L16-USB, L17-LSB with clarifier at 12 o'clock.

*Note\*\*\*\*Slide with Super Slide diode was +/-4kc, and with the Stock diode, slide was +/- 1kc.*

## **KIT #146 REVISED INSTRUCTIONS FOR REALISTIC TRC-453**

---

### **• DAVID C. COMPTON**

- (1) Isolate pin 10 by removing C67 located between IC2 and L38. SAVE C67!
- (5) Solder the Yellow wire to pin 10 in the hole where C67 was.
- (6) Solder the Green wire to the unused circuit trace that runs from close to pin 1 over to the channel ribbon cable at the front of the board. The green wire should go at the channel cable end.
- (7) Solder the 1pf capacitor that comes with the kit to the other end of the green wire's trace and to the other hole left by c67. From front to rear, the wiring should go as follows. Green wire thru trace to one end of supplied cap.  
yellow wire, then the other end of supplied cap.
- (8) Remove C66 and replace with cap C67.
- (9) Change R106 (100 ohm to 47 ohm) provided in kit. It is next to D26 just in front of pin 11 of IC(2)

### **CLARIFIER MOD**

- (1) Lift the ANODE of D23 and connect the Super Slide in series with it.
- (2) Short across R562 on Front Panel Control P.C. Board. Remove Jumper JP561 at top of Clarifier control. Run jumper from end of Clarifier pot where you removed jumper to JP556 located next to R599 directly below the "3" s units LED.
- (3) Remove D25
- (4) Clarifier range is now approx. 9.5 khz down and 4.0 khz up, xmit and rcv

### **OTHER MODS**

- (1) You may remove the wires from the switch on the back of the Squelch knob leaving the NB/ANL permanently on, and wire whichever band you prefer to the

## IMPROVING THE KIT#106

sw. contacts. Of course you will only have on band, as opposed to two but your radio will look STOCK.

## IMPROVING THE KIT#106

### • LEE LAUFER

I recently purchased kit#106 for a Cobra 146. After installing the unit, I noticed that the injector worked correctly to give the low and high frequencies, but the middle frequencies (ch.1-40) are not covered. The fault is with the radio's vco which doesn't produce enough energy to equal the injector's own energy level. The radio was tuned to get only the high and the middle frequencies, but the radio

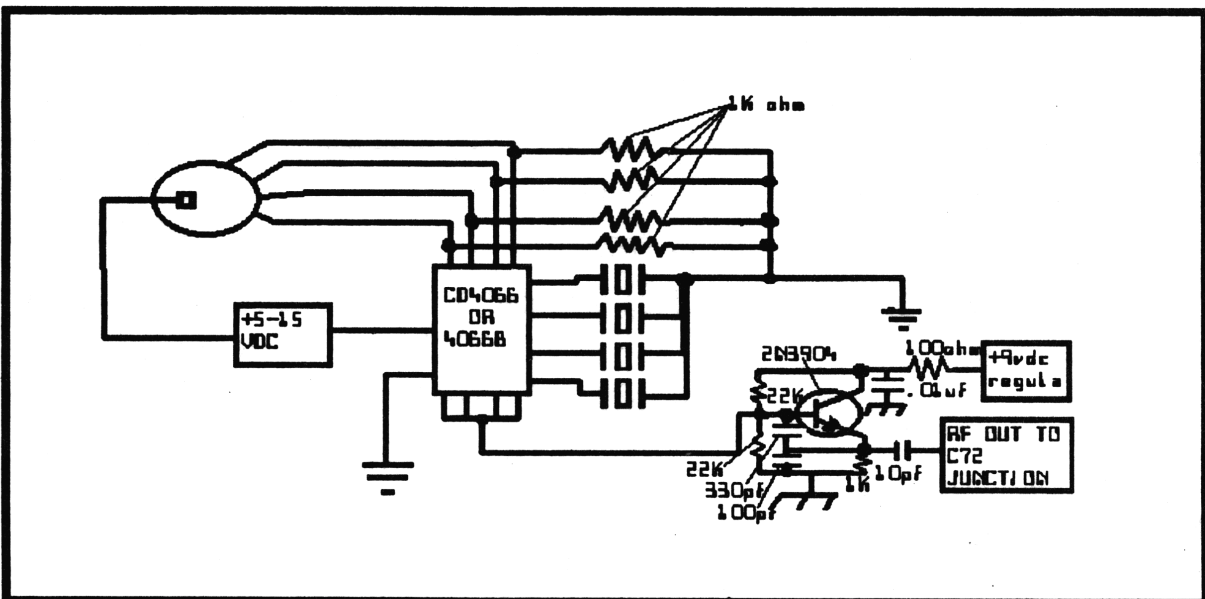

FIGURE# 16.....CD4066 SWITCHING CIRCUIT

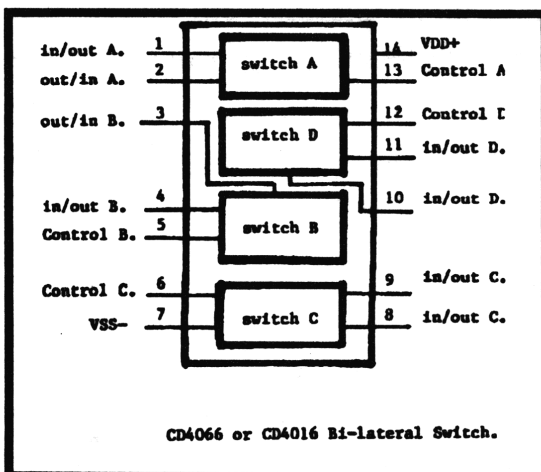

FIGURE# 17.....CD4066 PIN OUT DIAGRAM

would not cover this set because L13 doesn't tune flatly. The Super Diode was installed next to L14 and it did improve L14's tunability as it was written in the instructions. With this in mind, the kit#106 can be improved by using a three xtal. osc. or by having two switches, with one for the extra xtal. I used an electronic switch and a 2N3904 osc. and that did the trick. The output of the oscillator is .5volts of RF.(see diagram)

## **THE HAM RADIO SECTION**

---

### **THE ICOM 730**

---

The WARC bands (10, 18 & 24 MHz) are unlocked on the ICOM by opening R48 on the RF circuit board. With the rig facing you, the RF board is on the left hand side.

CB freq. and beyond can also be added. Replace x8 & X9 located on the Premix board (located on the bottom in the middle). Replace them with 53.4315 & 53.9315 crystals. The readout will show 27.9 - 29, with the actual freq. 26.9 - 28 mhz. freq. adjustment is L8 & L9.

Crystals are HC18/U, 20pf.

### **THE ICOM IC-725 MARS MOD**

---

#### **• LESCOMM**

(1) Cut or remove D5 on PLL board for general coverage TX.

### **THE ICOM IC-735 MARS MOD**

---

(1) Remove top & PA Heatsink.

(2) Locate D33,34. (To the left of J22) Clip or remove both. Diodes have YL insulation on them. (Gives general Xmit).

### **THE ICOM IC-751A GENERAL COVERAGE TX**

---

#### **• RAYS RADIO**

(1) Remove transceiver top cover.

(2) Locate J2 on the RF board.

(3) Cut the black wire from J2.

(4) Replace the cover.



## **THE ICOM IC-765 MARS MOD**

### **THE ICOM IC-765 MARS MOD**

---

(1) Remove or cut D53 from Matrix board. Diode is next to S36/37 on front of Rig, visible from the bottom.

### **THE KENWOOD TS-140 MARS MOD**

---

- (1) Locate Control board on bottom.
- (2) Remove or cut D31.
- (3) Reset microprocessor.

### **TS-140S 11MTR MOD**

---

#### **● BILL G.**

Clip D29 & D31.

### **THE KENWOOD TS-930S GENERAL XMIT**

---

#### **● RAYS RADIO**

- (1) Remove transceiver top cover. (8 screws).
- (2) Remove four screws from speaker mounting and top panel assembly.
- (3) Swing the assembly away and unplug the red, blk battery backup leads.
- (4) Jumper the following pins,
  - a.IC21 Pin 12 to IC11 Pin 9
  - b.IC22 Pin 12 to IC12 Pin 9
  - c.IC23 Pin 12 to IC24 Pin 8
- (5) Replace speaker assembly and top cover. Happy DXing.....

### **THE KENWOOD TS-940S GENERAL XMIT**

---

#### **● RAYS RADIO**

- (1) Remove both covers from transceiver.
- (2) Locate the digital unit B. (Closest to front panel)

## THE YAESU FT-747GX GENERAL XMIT

- (3) Remove or cut diodes D130 and D135.
- (4) Press and hold the {A=B} switch while press power switch on and off. This will reset the microprocessor.
- (5) Replace all covers.

## THE YAESU FT-747GX GENERAL XMIT

### ● GENE S.

- (1) Disconnect power and antenna connections.
- (2) Turn on power switch to discharge capacitors.  
*NOTE: All work done on Main PC board, back of Front Panel on Lower side of panel favoring right lower side. Looking at component side, there is a ribbon wire running from microprocessor to main board. Next to it is a looped brown wire sticking out all by itself. This is the wire to cut.*
- (3) Cut the looped brown wire going to the chip. Be sure to insulate the ends.
- (4) Reconnect power connection and turn unit on.
- (5) Dial radio to 123456.
- (6) Shut power off.
- (7) Turn power back on. Unit will now transmit on all frequencies.

## THE YAESU FT-757GX-II GENERAL XMIT

### ● ALAN LAPE

Refer to diagrams

- (1) Remove the screws securing the top.
- (2) Lift the cover in which the PA unit is in, out of the way to gain access to the inside front of the unit.
- (3) Locate the display unit behind the front panel shown in the diagram.
- (4) Locate the black switch shown in the drawings.
- (5) One figure shows it in right position for HAM usage.
- (6) Slide the black switch to the left for transmitting capability.
- (7) Reinstall the top cover, The modification is complete.

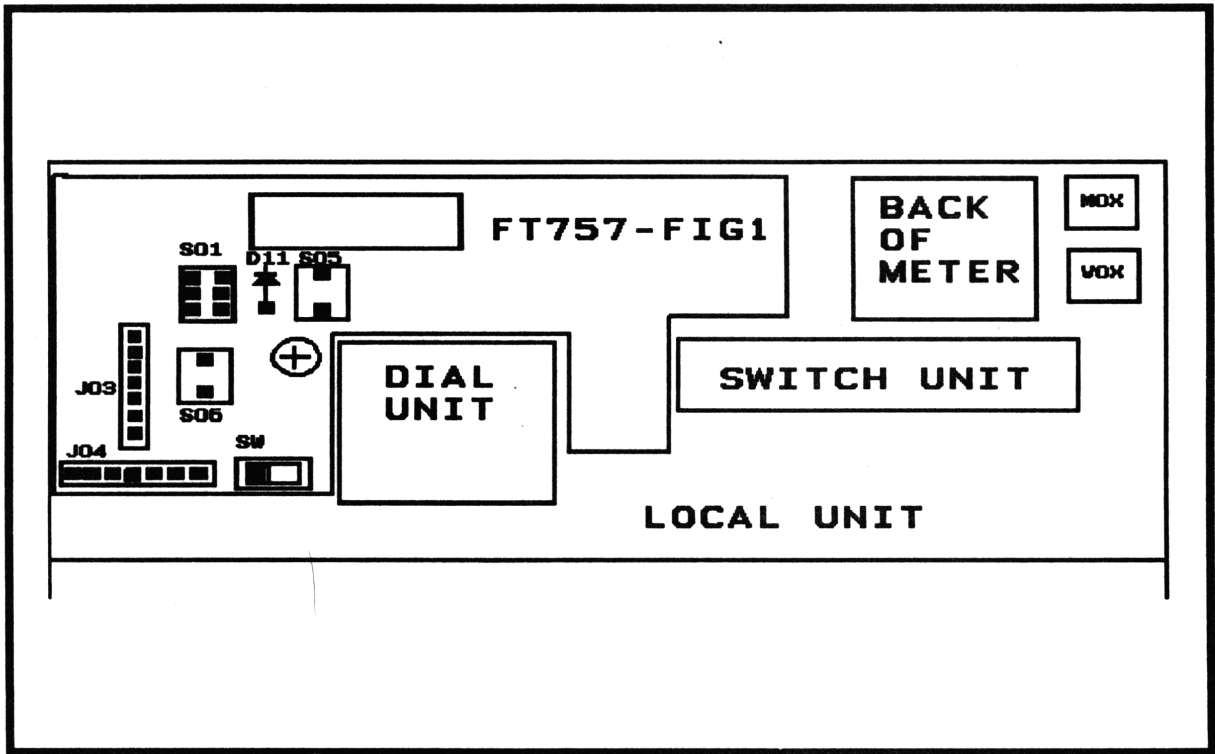

FIGURE# 18.....YAESU FT-757GX-II, DIAGRAM-A

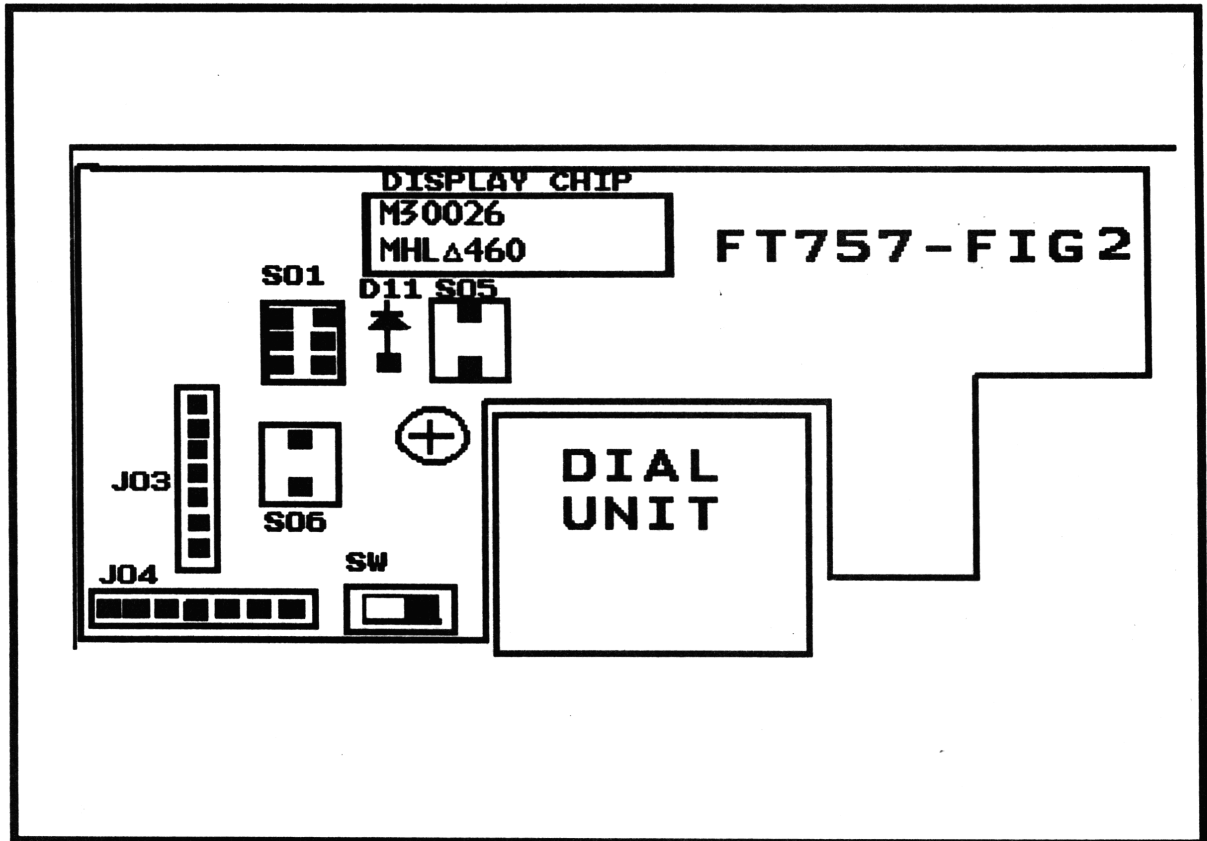

FIGURE# 19.....YAESU FT-757GX-II, DIAGRAM-B

## **TECHNOTES PART II**

---

### **TC SSB KIT IN THE COBRA 21,25 or 29**

---

#### **● Courtesy Card Kit**

The question might arise as to whether or not the TC SSB kit can be used on a Cobra 21, 25, or 29 Plus unit or not. The answer is, yes it can, but you will have a zero beat signal on your regular 40 channels. These units have no delta-tune or voice-lock as does the Cobra 146GTL, so you cannot zero the beat out. If a technician wishes to use the TECH'S CHOICE SSB and the zero beat is not a problem here is the procedure.

1. Using a set of Jan. '87 Tech Notes, follow all parts of step one, omitting part 7.
2. Follow all parts of step two, except you must supply your germanium diode, down to part 5.
  - 5a. Solder the black wire of the switch PC board to the shield of the upper tank on the epoxy pack and then to ground.
  - 5b. Solder the white wire of the switch PC board to the orange dot terminal on the epoxy pack.
  - 5c. Run a wire through the hole drilled in the PC board and solder the other end to the blue dot terminal on the epoxy pack.
  - 5d. Run a wire from the yellow dot terminal on the epoxy pack to TP-2.
  - 5e. Run a wire from the cathode of D-27 (D-23 on 29 Plus) to the cathode of the germanium diode D-15. Part 6 remains the same.

## **APRIL TECH'S NOTES**

### **Alignment**

All parts of the alignment procedure are the same except, omit part 2, and the frequencies that you adjust for, will be the metal stamped or red side markings on the crystal. The two crystals supplied with the kit will give you 27.415mhz and 27.420mhz. Now someone is going to conclude that if a TECH'S CHOICE SSB kit will work on the AM's, then a TECH'S CHOICE AM should work on an SSB. The answer is no it will not and here is why. You have made circuitry changes that cannot be switched back and forth. (Namely the capacitor in the tuning of L-39 and the cross over of the USB and LSB switching).

Let's help each other do a better job.

For those of you that have not discovered the 5x5 Francis whips yet, you probably will have problems with high swr when using the TECH'S CHOICE SSB kit. Most antennas are not designed for broad bands. For those that have discovered this whip already here is some tuning hints. As shipped, it is tuned to the regular 40 and 40 channels below. If you put a spring (such as the Tite-Lok #304) under it, you must trim it off about twice the length that is covered by the cap to keep it tuned to the same frequency. For each 40 channel bank you wish to shift this whips' tuning upward, you need to cut off an additional amount equal to the length covered by the cap. If you take a stock whip and just put a spring under it, it would be tuned to approximately 26.065mhz.

## **APRIL TECH'S NOTES**

---

W-e-l-l, here it is. Several of you have been waiting for the modification for the base units and the 148GTL. We will be covering more of these units that the TC DX modifies. More specifically in the future tech's notes. But the basics are the same. Only the break-in points or component numbers will change.

One great advantage of this DX kit when compared to others is, no longer will you need a test set or frequency generator. Just modify yourself a bench set and select any frequency you want instead of fumbling with a signal generator and frequency counter. Having them drift off frequency while you are trying to make an adjustment is very frustrating. If I could ever give you one piece of advice that would save you time and make your work easier, it would be, "make yourself a test set." You can make it either from a Cobra 142GTL or (if you want a read out too) wait until next month and modify a 2000GTL. If you want something cheaper

and something that will give you even a greater span, modify a Cobra 146GTL or a Uniden PC-244. Combine the switching of a "C" kit with the TC SSB to give you up to 480 channels. (Including side-band 1,440 frequencies) Too, you'll find the zero beat a Plus when it comes to checking a side-band unit. When you make your test set, put it on a 50 ohm load with about a two foot coax. The ambient radiation will be enough to pick up a good strong signal several feet away.

### Tech's Notes

In our original plans for these new conversions kits, our sequence of production was to be the TC AM, TC SSB, and the TC DX. Then the C & D kits as a scaled down version of the SSB & DX. On the way to achieving this time schedule, the FCC threw a monkey wrench in the works. They have amended part 97 of the FCC regulations to allow Novice to go voice from 28.300mhz to 28.500mhz. So we had to move the "C" kit forward in our schedule to meet this need. Since the only difference in the "C" kit and the TC SSB kit is the switching, there is no need to repeat the procedure. The switch for the "C" kit is a DPDT center off switch with one of common terminals of one pole clipped.

*Note: This kit comes with two crystals. One is for regular CB frequencies. The other might be any of the obtainable frequencies. Before you do anything, determine if these crystals are of the frequency you desire. The frequency stamped in black is the frequency for that crystal on channel 1.*

1. Solder the two crystals across the end terminals of the switch, pole to pole.
2. Solder the double trimmer capacitor across the legs of the two crystals on the side where the common terminal has been clipped.
3. Solder the black wire to the point where the two capacitors are joined.
4. Solder the white wire to the common terminal on the other pole. You can parallel as many of these switches as you desire because the center off feature on the switch allows for this. Each additional switch allows you to add two more groups of frequencies.

## **THE TECH'S CHOICE DX (TC-DX) and the "D" kit.**

### **THE TECH'S CHOICE DX (TC-DX) and the "D" kit.**

These kits are designed for the side-band units having a 7.8mhz, 1st I-F. The Cobra 140, 142, 148, and 2000GTL. The President and Uniden, Madison, Grant, and Washington, and sister units.

#### **Modifying the Cobra 148GTL, using the TC-DX kit.**

1. Before removing the cover, locate and mark a point on the lower cover, (opposite side from the mike) 2 1/4" to the rear and 9/16" down from the edge (where the clam covers meet).
2. Drill a locator hole at this point (approx. 1/8") through both the cover and the chassis.
3. Remove covers.
4. Place the round decal on the cover, centered on the 1/8" hole. Punch a 13/32" hole in the cover and the chassis, using the 1/8" hole as a guide. Mount the crystals on the switch PC.
5. Using a 1/4" punch, nibble down the edge of the chassis, directly in-line with the center of the 13/32" hole, to fit the key on the switch.
6. Using a filler board supplied, mount the group selector switch.
7. Using plastic adhesive such as 3m 4475, mount the epoxy pack just to the rear of the rear most bracket mounting hole, with the orange dot up and forward.

#### **Step Two**

1. Solder the black wire from the group selector switch to the upper tank's shield on the epoxy pack. Then run it to the shield of L-45.
2. Connect the white wire to the orange dot terminal on the epoxy pack.

## **THE TECH'S CHOICE DX (TC-DX) and the "D" kit.**

3. Locate the output of L-47. Cut it and TP-1 away from the rest of the PC pad.
4. Connect a wire from TP-1 to the blue dot terminal on the epoxy pack.
5. Connect a wire from the yellow dot terminal on the epoxy pack to the other open hole on the pad you cut.
6. There are two tanks feeding the mixer chip. One has blue markings and the other has black. Find the resistor feeding the black tank from this PC pad. Replace it with the .01uf capacitor supplied.
7. Connect the red dot terminal on the epoxy pack to pin 8 on the UHIC 007 chip, or to any open hole on that same PC run.
8. Connect the 150pf capacitor supplied, across the outside legs on the three leg side of the black tank feeding the mixer chip.
- \*9. Under the epoxy pack there is a 2pf capacitor (C-163) between the output of L-46 and the three leg side of L-45. On the PC side of the board parallel it with the 18pf capacitor supplied.
- \*10. Just to the rear of L-25 find C-161. Remove it.
- \*11. Just to the rear of the C-160 there is a 330 ohm resistor. Change it to a 470 ohm.
- \*12. In the receiver section, find L-5 and L-6. There is a 2 pf capacitor coupling these two tanks. On the PC side of the board, bridge these two points.
- \*13. Beside TR-14 you will find R-48 sitting in an angle. On the PC side of the board, parallel this resistor with a 1.5k resistor.
14. On the front edge of the PC board find JP-17 and JP-18.  
Remove these two jumpers and cross wire them.



## **MODIFYING THE COBRA 148GTL Using The "D" Kit.**

### **Alignment**

With a counter connected to read the transmitter frequency, apply power.

1. Connect a scope to the yellow dot terminal of the epoxy pack. Adjust the tanks on the epoxy pack and the black tank on the input to the mixer for the best and most clean signal. Adjust too, for the same amplitude of signal at each end of the frequencies you have installed crystals for.
2. Select channel 1 and adjust each capacitor of each group frequency crystal. The frequency it should read is stamped in black on the side of the crystal.
3. Do a normal transmitter-receiver alignment using center frequency. If everything has been broad-banded properly, the extreme ends of the frequencies should be about half power points.

## **MODIFYING THE COBRA 148GTL Using The "D" Kit.**

---

Make up your switch or switches as previously outlined for the "C" kit. The hook-up procedure is the same except: if your frequencies do not exceed 120khz. You can omit those steps marked with an (\*). Broad-banding should not be needed modifying the Cobra 142GTL, using the TC-DX kit.

1. Remove covers.
2. Remove Dynamike control and secure it to the mike plug and power switch wires. Note: Leave the control fully cw.
3. Enlarge the hole where the Dynamike control was removed to 3/8".
4. Mount all crystals in the switch PC board on the printed circuit side, leaving them standing about 1/4".
5. Change the white and black leads, for wires of about 10" long each.

## **MODIFYING THE COBRA 148GTL Using The "D" Kit.**

6. Using one of the washers from the group selector switch, cut a hole in the round decal the size of the washer's outside diameter. Place this decal on the front panel.
7. Mount the switch.
8. Mount the epoxy pack on the bottom side of the metal chassis, next to IC-5 (transmitter mixer) with the orange and blue dots forward.

### **Step Two**

1. . Connect the black wire of the switch to the shield on the right side tuning tank. Then solder a wire from this tank to the ground on the PC board near L-14.
2. Connect the white wire to the orange dot on the epoxy pack.
3. Locate the output of L-14 (TP-1). Cut the PC run at the output of L-14.
4. Connect a wire from the output of L-14 to the blue dot terminal on the epoxy pack.
5. Connect a wire from the yellow dot terminal on the epoxy pack to the part of the PC pad across the cut from L-14.
6. On this pad, find the resistor feeding the black tuning tank for the transmitter mixer. Replace it with the .01uf capacitor supplied.
7. Run a wire from the red dot terminal on the epoxy pack to pin 8 of the UHIC-007 mixer (IC-1).
8. Solder the 150pf capacitor supplied across the outside legs of the black transmitter mixer tank, on the three legs side.
- \*9. At the rear left corner of the epoxy pack find C-160 (1.5 to 5pf capacitor). Parallel it on the PC side of board with the 18pf capacitor supplied.

## **Modifying the Cobra 21 & 25LTD, AR & AX-44/Uniden PC-66**

\*10. Just to the rear and left of this point, find C-157. Remove it.

\*11. Next to C-157 there is a 330 ohm resistor. Replace it with a 470 ohm resistor.

\*12. In the receiver section find L-8 and L-9. There is a 2pf capacitor coupling these two tanks (C-38). Jumper across C-38 on the PC side of the board.

\*13. Just to the rear of L-9 you will find a 10k resistor R-40. Stand the leg of it up and solder a 4.7k resistor where it was raised from. Solder the two legs together (putting them in series).

14. Find the green and blue wires coming from the mode switch to the PC board, near L-21 and L-22. There are two jumpers just forward of them (JP-25 and JP-26). Remove these two jumpers and cross wire them.

Alignment is the same as for the Cobra 148GTL.

### **Modifying the Cobra 142GTL using the "D" kit**

Procedure is the same as for the Cobra 148GTL except: we recommend that the switch or switches be mounted between the voice-lock and mode switches. Place them higher or lower but not in-line, both of the switches are to be used.

## **Modifying the Cobra 21 & 25LTD, AR & AX-44/Uniden PC-66**

**and other sister units, using the "LTD" kit for High and Low channels.**

### **Step One**

1. Before removing the covers, drill a 1/8" spotter hole through both the cover and chassis, 3/4" to the rear and in line with the upper mike bracket mounting hole/right side of unit.

2. Remove covers, mark and drill two more 1/8" holes 13/32" front and rear of the spotter hole on the chassis.

## Modifying the Cobra 21 & 25LTD, AR & AX-44/Uniden PC-66

3. Now punch or drill the spotter holes in the cover and on the chassis to 3/8".
4. Mount the switch with one flat washer inside and one outside.
5. If you are modifying for 1/2 channels leave the switch as is, but if you desire full channels high and low, change wire I to the center contact of that pole and solder the VE supplied across the two wires H & I.

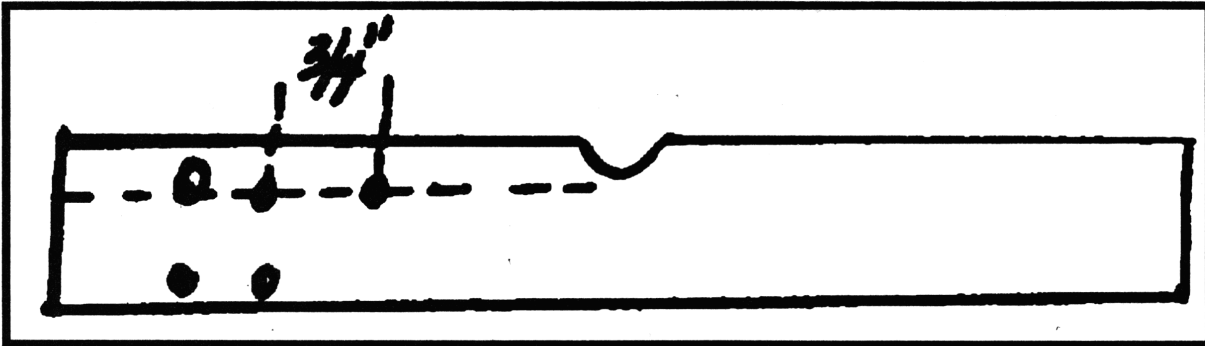

FIGURE# 20.....COBRA 21/25LTD,PRES.AR/AX-44,UNIDEN PC-66

6. Hold the epoxy pack up against the chassis just to the rear of the mounting screw hole with the orange dot up and forward. You will notice that it will not go down far enough to allow the cover to be replaced, because of the capacitor and tank. Use a wood rasp and file off the bevel in that area. Stop when you can see the fiber of the PC board. This will allow it to sit low enough to clear the cover.
7. Using 3m 4475 plastic mount the epoxy pack. Make sure the mounting screw hole and the core of L-18 is clear.

### Step Two

1. Remove JP-14.
2. Cut the PC run on the output of L-16, between where JP-14 was removed and the large hole (TP-3).

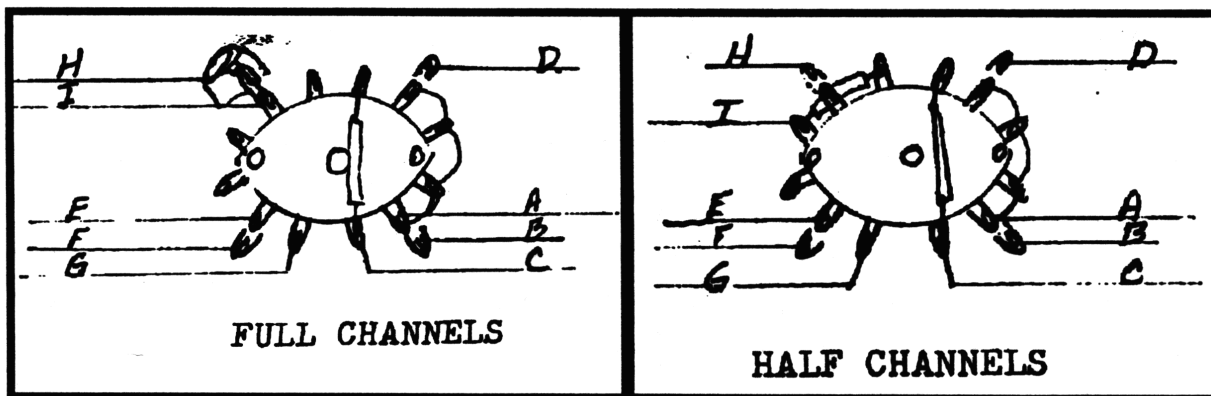

FIGURE# 21.....FULL CHANNELS, LTD KIT      FIGURE# 22.....HALF CHANNELS, LTD KIT

3. Remove R-58. Turn it around and solder the body back where the leg was but leave the leg raised.

4. Run a ground wire to the upper tank shield on the epoxy pack from the shield of the L-17.

*Note: If full channels are desired, also do these steps:*

1a. On the PC side of the board, cut the PC run between the 10.24mhz crystal and C-111. (If VC-1 is not used replace C-111 with a 33pf capacitor in order to be able to add capacitance in parallel to adjust the frequency if needed. (If VC-1 is used, remove C-111).

2a. Run a jumper wire from the cathode of D-14 to the red dot terminal on the epoxy pack.

### Connecting the 4P/3T switch for 1/2 channels.

1. Bare the wire marked "A" on the diagram at the distance that will allow you to solder it to the blue hook terminal on the epoxy pack, then continue it to the point you removed the right end of the JP-14.

2. Connect wire "B" to TP-3.

3. Connect wire "D" to the input of IC-2 (TA7310p) which is the left end of JP-14. Change C-83 (input to pin 1 of the TA7310p chip) out with the 47pf capacitor supplied.

4. Connect wire "D" to the yellow dot terminal on the epoxy pack.

## **Modifying the Cobra 21 & 25LTD, AR & AX-44/Uniden PC-66**

5. Connect wire "E" to the PC board where R-58 was raised from.
6. Connect wire "F" to the raised leg of R-58.
7. Connect wire "G" to pin 1 of IC-1 which is the PLL chip.
8. Connect wire "H" to the cathode of D-14.
9. Connect wire "I" to the red terminal on the epoxy pack connecting the 4 pole 3 position switch for full channels same as above up to parts 8 & 9.
- 8a. Connect wire "H" to where VC-1 should be or if it is used, to the point on that same run where you removed C-111.
- 9a. Connect wire "I" to the 10.24mhz crystal (across the cut from C-111).

### **Alignment**

With a counter connected to read transmit frequency.

1. Select channel 26 and normal channels (center position)
2. Adjust VC-1 or trim C-111 to read a transmit frequency of 27.265mhz.
3. If you have modified for full channels, switch to low channel 5 and adjust the varicap on the switch for a transmit frequency of 26.815mhz.
4. Select the high channels and adjust the varicap on the epoxy pack for a transmit frequency of 27.725mhz. Or if you have modified for 1/2 channels, adjust for 27.720mhz.
5. Do a normal TX-RX peaking using channel 26.

### **Tricks of the trade on this unit**

#### **Increasing the receiver gain on this type unit.**

The easiest way to increase gain on almost any amplifier stage, is to decrease the self-bias in that stage. In the case of the Cobra 21 & 25GTL and LTD and other sister units, the self-biasing resistors are R-3 for TR-1, R-6 for FET-1 and R-9 for FET-2. All of these resistors are 1k resistors. They can be changed to 750 ohms +/- 70 ohms. The further back in amplification (meaning the first stage) the greater the results will be. Paralleling a 1k resistor with a 3.3k will result in a 790 ohm total. Paralleling a 1k resistor with a 3k will result in a 750 ohm total. So make the

## Modifying the Cobra 21 & 25LTD, AR & AX-44/Uniden PC-66

change in the first amplifier and check you results. If you still want more then go to the second and so forth. A word of caution: Do not boost the receiver too far beyond the range of the transmitter because the operator will be trying to answer people that cannot hear him. Also, on the units that do not have receiver gain or RF gain control, when the sun spots start again in about two years, you might be asked to undo what you have done.

### Boosting The Transmitter

This is a trick that I have shown technicians as long as a year ago, while traveling. I called one of these technicians today just to see if he had made any money off this trick. He said that he has made somewhere between 3 and 5 thousand dollars on this trick since I showed it to him last July. He said that he uses so many capacitors, he orders them by the 100's from Mouser.

If you will notice on your schematics C-46. The coupling capacitor between the driver and the final. It is a 250pf. Most of them will be in this range except for the Midland M series and the Thousand series. On these they are about 100pf. Change or increase these 250pf caps, 68-100pf. The easiest way is to just parallel them on the PC side of the board with a 68-100pf

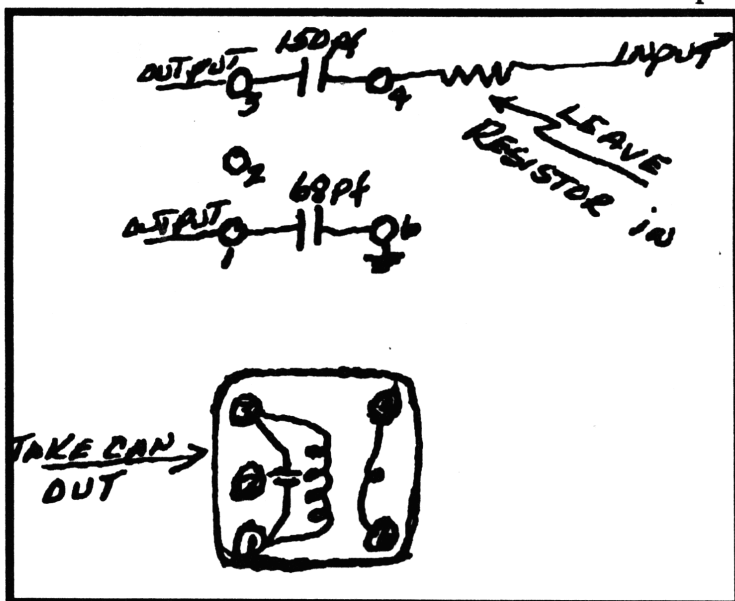

FIGURE# 23.....BOOSTING THE TRANSMITTER

capacitor. On the Midlands do not exceed 47pf.

If you charge say, \$7.50 for a transmitter peaking, you should ask an additional \$10.00 for boosting. You have to cover yourself in case the customer has high swr and will not admit it. Attached is a partial list keep it handy and keep adding to your list. In any procedure devised by man, there is always room for improvement. This is the case of the procedures for the "TC-DX & D kits." we have

found that if we capacitive couple the epoxy pack signal into the transmitter mixer, instead of using the inductive coupling that is there, we have a broader band coverage. Also, we find that if we treat the two series tanks in the receiver the same

## Modifying the Cobra 21 & 25LTD, AR & AX-44/Uniden PC-66

as we did the two output tanks of the mixer in the transmitter, we get the results we want while retaining their individual tuning capabilities. So in the procedures where it says to short across this capacitor, change it to parallel it with a 10-18pf capacitor. In the procedure for the Cobra 148GTL and 2000GTL (Apr & May Tech's Notes) Change the part of step two that says to remove the resistor that feeds the black tank. Leave it there. Remove that black tank itself and use the 150pf & 68pf capacitors as illustrated below. Let's help each other do a better job

Type Of Unit	Cap To Parallel	Size	Parallel With
Cobra 18&20	C-42&C-41	33&220pf	47pf
Cobra 18 Plus	C-98	270pf	68-100pf
Cobra 19X	C-325	82pf	< 47pf
Cobra 19XS	C-245	82pf	< 47pf
Cobra 19Plus	C-312	100pf	47pf
Cobra 21LTD&GTL	C-46	250pf	68-100pf
Cobra 21Plus	C-87	270pf	68-100pf
Cobra 25GTL&LTD	C-62	250pf	68-100pf
Cobra 25 Plus	C-87	270pf	68-100pf
Cobra 29GTL&LTD	C-62	250pf	68-100pf
Cobra 29XLR	C-57	250pf	68-100pf
Cobra 29 Plus	C-87	270pf	68-100pf
Cobra 90LTD	C-355	100pf	47pf
Midland 77-104	C-94	60pf	< 47pf
Midland 77-856	C-37	220pf	68-100pf
Midland 151M	C-325	100pf	47pf
Midland 3001	C-325	100pf	47pf
Midland 4001	C-325	100pf	47pf
Realistic TRC-414	C-93	100pf	47pf
Realistic TRC-421&421A	C-93	27pf	< 47pf
Realistic TRC-422&422A	C-93	27pf	< 47pf
Realistic TRC-432	C-105	27pf	< 47pf
Realistic TRC-433	C-104	27pf	< 47pf
Realistic TRC-441	C-93	27pf	< 47pf
Realistic TRC-473	C-105	27pf	< 47pf
Uniden PC-33&55	C-41&42	33&220pf	< 47pf
Uniden PC-77	C-109	270pf	68-100pf
Uniden Zachary T.	C-61	100pf	47pf



## **Select-A-Watt or Dial-A-Watt**

---

- **Contributing Technicians: All the technicians at, Slim's C.B. And Radio Center Port Allen, LA. (Original) and Frank Fournier (improvements)**

Select or Dial-A-Watt is a method of doing two things. 1. Making a unit drive at the proper level to feed an amplifier while having a peaked unit when the amplifier is not being used. 2. A way of lowering the carrier level of a unit while maintaining all of the pep swing of the audio. Almost every AM unit has an anti-spiking diode on the output of the audio transformer. This is where the dc is fed to the driver and final. The reason it is there is to prevent the RF positive spikes from exceeding the insulation factor of the audio transformer, causing shorting between the primary and secondary. This diode is generally a 1 amp. 600V peak reverse (prv). This is also about the same as most of the protection diodes. Most of you have these by the dozens in your shop, if not hundreds. Silicone diodes require about .7 forward biasing voltage to began conduction. This means, if we put two such diodes in series, it would require about 1.4 volts to start conduction, three, 2.1 volts, etc.

As you know, when you lower the voltage on the driver and final of a unit, your wattage output on dead key will drop. The audio swing in this case will not drop because the diodes are already forward biased. Any positive swing will be coupled through 1:1.

We can lift the cathode of the anti-spiking diode and add as many diodes in series as we desire. We can have as many levels of carrier as the number of diodes we install. Let's start with a simple SPDT switch. It will give us two levels. Peaked level for normal operation and a lower level, say, for driving an amplifier. Let's say it takes three diodes to give us the desired level of drive for the amplifier. With the SPDT switch closed you will have peaked condition. Let's say 6 watts swinging 18 watts. With the switch open it might drop to 3 watts but the swing will be 15 watts. Now let us consider a DPDT switch with center off. This could give us three levels.

## Select-A-Watt or Dial-A-Watt

Up, would give peaked condition. Down would give a lower level, and center would give the lowest level. Now for those of you that have followed our suggestion and bought yourself a set of hand punches and would like to be more professional, you might want to try Dial-A-Watt. For this we would like to suggest a 2 pole 6 position switch such as Mouser's #10wk026. It is a printed circuit switch but the layout on this switch is easier.

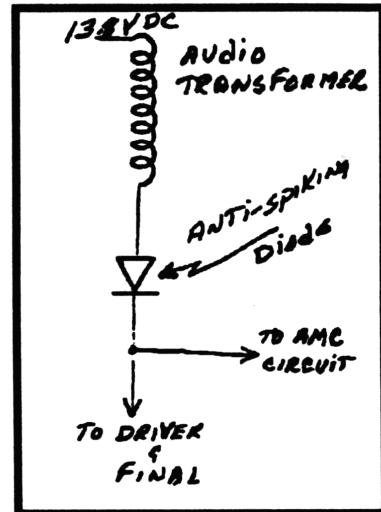

FIGURE# 26

1. Lay the outside terminals of one pole out at about a 45 degree angle.

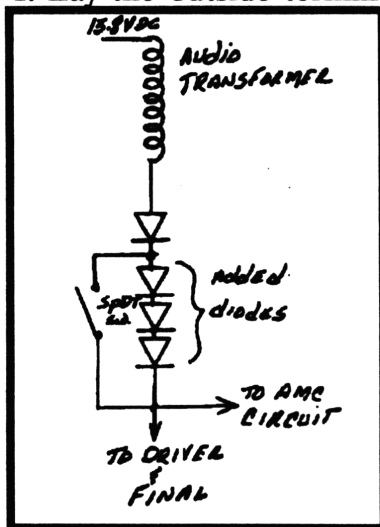

FIGURE# 25

2. Bend the legs of five diodes as illustrated leaving the legs about 3/8" long.
3. Starting at pin #1, solder the diodes between 1 and 2, 2 and 3, 3 and 4, 4 and 5, 5 and 6, with the cathodes toward pin 6.
4. Mount the switch.
5. Lift the cathode of the anti-spiking diode.
6. Run a wire from the raised cathode to pin 1.
7. Run a wire from where the cathode was raised from, to the

common terminal and to pin 6. Now as you rotate the knob cw, the wattage out will increase. As you rotate ccw it will decrease. This mod is such, that if you have spare-time in your shop, you can make up and wire a few of these switches in advance. Then all you have to do is mount the switch and wire it in.

### Suggestion

Put yourself a sign in your shop

An average shop should make an extra thousand dollars or more off of this modification each year.

Let's help each other do a better job

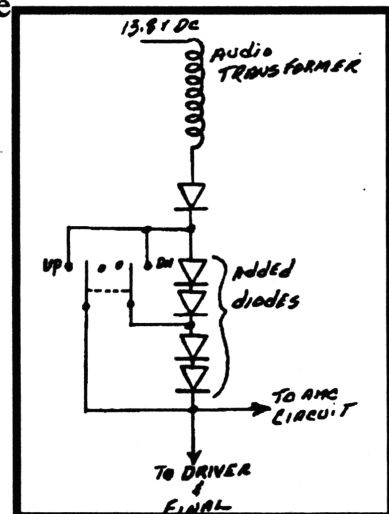

FIGURE# 24

## The Circuit Of The Month

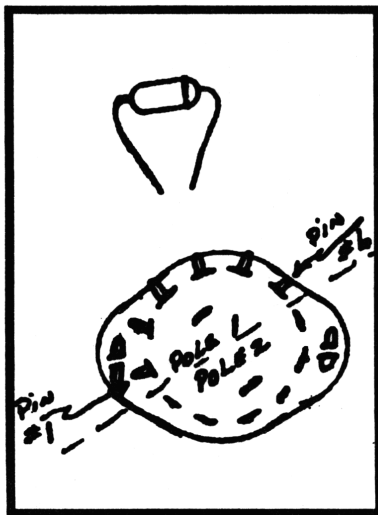

FIGURE# 27

Last month we had an article on how to increase the receiver gain on units by decreasing the self-biasing on the amplifier. Of course the opposite is also true. You can decrease the gain of an amplifier by increasing the self-biasing. Why I feel that this is worth mentioning is that I've received a couple of calls this month were technicians were having trouble with the TC-DX kit when they capacitively couple them as we suggested last month. You will notice this high pitched squeal as you bring L-7, 8, and 9 to their peak and remove your tuning tool. This means that your mixer/amp, is picking up enough feed-back to put it into oscillation. The Fix:

Increase the size of the mixer/amp's self-biasing resistor from 100 ohms to 470 ohms. If this is not enough, make it 680 ohms. In the case of the Cobra 148GTL, 2000GTL and the Grant, this resistor is R-52. In the Washington R-44 and the Cobra 140 & 142, R-43.

This is a feature we will attempt each month if it is favorably accepted. After viewing and studying this article we would like your opinion.

Call 1 (800) CARD-KIT.

## The Circuit Of The Month

---

It is only fitting that we start with the lesser written about section of a unit, (the receiver) and where else should we start except the beginning or input circuit.

In its simplest form, the first amplifier stage's input could consist of a small coupling capacitor C-1, a tuneable RF tank of the proper frequency (27mhz.) T-1, another capacitor C-2 to couple the RF signal on to the control biasing voltage divider network for the RF amplifier (see fig. #1). This is fine except there are other things to be considered. First, what size should C-1 be? Well, it has to be small because its source is the 50 ohm impedance matching pad, that has to match the impedance of the coax and antenna. It cannot be a heavy load on that source even when the tuneable tank shows a small load. You will find they will range from as large as 47pf, down to as small as 2 or 3 pf. In this circuit, what would happen if a large signal were to strike the antenna? It would cause heavy conduction in the RF amplifier and if it continued for a length of time, it would over heat the transistor, causing damage. We must protect against this. So, we put in two back-to-back

## The Circuit Of The Month

diodes (fig. #2) D-1 & D-2. Generally these will be Germanium diodes because who needs a signal level more than .2 volts peak to peak. This limits how large the capacitor C-1 can be because if it takes more than the forward current rating of these diodes to charge and discharge the voltage change on this capacitor, they will blow. However, the capacitor must be large enough so the current caused by minority carriers will not change the charge or load on the capacitor. This means the reverse resistance of the diode and the size of the capacitor must present more than 5 time constants to the 27mhz signal. How does all this benefit you? Well, if you have a unit that keeps blowing diodes and RF amps, check the size of C-1. If it is something like 35pf you might try changing it to a smaller size, say 22pf. Now, one other thing that we want to consider in a RF amplifier. We want to hear distant signals and close signals. You can't make them all the same amplitude but you can amplify the more distant ones, more and the close ones, less. The circuit we use to do this is called automatic-gain-control, (AGC). If we can detect and change this gain at an audio rate, we call it fast AGC, (FAGC). This of course only works on the small section of the RF amp band width to which we are tuned at that time. If someone generates a large signal within the amplifier's band-pass but not on the channel to which we are tuned, it will saturate the amplifier and drown out the weaker signals. This is why your needle will drop down when you are hit with a strong signal that is on another channel. Now back to FAGC see fig. #3. Looking at the 455khz amplifier output and splitting it on the zero line, you can see we have identical intelligence riding on the peaks of both halves. If we want negative FAGC, we rectify and filter the negative half. In this case the positive half is rectified and sent to the audio amplifier. In fig. #4 we have taken this same type of amplifier stage and added manual gain. (Or RF gain)

This is accomplished by paralleling the self biasing resistor R-3 with a manual controlled pot VR-1, but it must be limited to prevent damage to TR-1. So, in series with the variable resistor we add R-4. All of these types of controls of the input and gain are called conventional methods. In the past decade, however more and more of the units are being manufactured using non-conventional methods. They take the FAGC, RF gain, the protection diodes, and sometimes

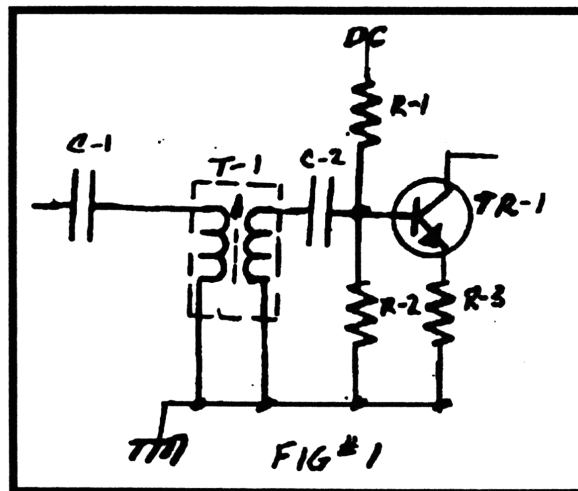

FIGURE# 28.....CIRCUIT OF THE MONTH

# The Circuit Of The Month

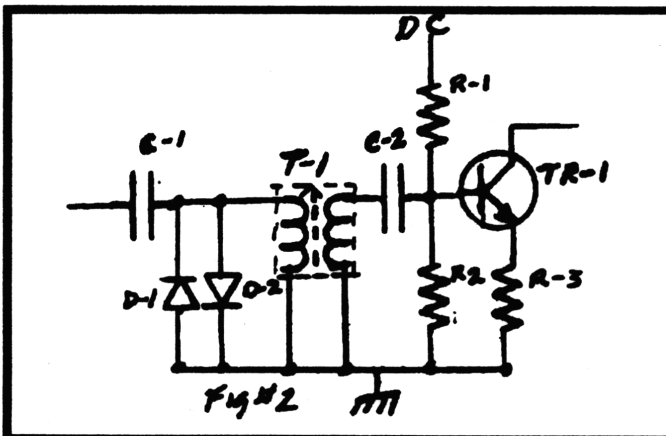

FIGURE# 29.....CIRCUIT OF THE MONTH

even the TX/RX switching and combine them into one control circuit. This combined circuit is placed between the input capacitor C-1 and the input tunable tank T-1. Looking at fig.#2 again, if we add a third diode D-3 in parallel with D-1, there would be very little change in the load caused by the circuit. If we add another capacitor C-3 in series with C-1 (and we made it 500 times larger) there would be no relative effect on the circuit. If we put a 1meg resistor in the circuit instead of D-3, there would be no relative change, but if we made it a variable 1meg resistor it would depend on its setting as to how much loading effect it would have on the circuit. Also because of the coupling of C-3, when the resistance got small enough to cause a lot of current flow, it would become a load on T-1. This would have the effect of lowering and broadening its bell curve. This brings us to the reason for this discussion. Never try to tune the 1st. Rf tank on a non-conventional unit, with more than 1 or 2 "s" units of signal, and always have the RF gain control fully cw (on). How to test the

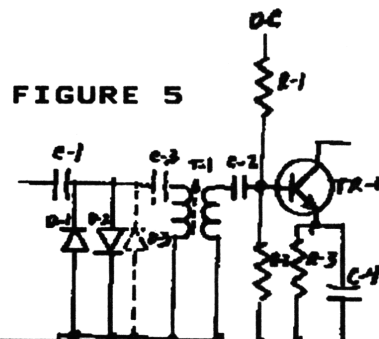
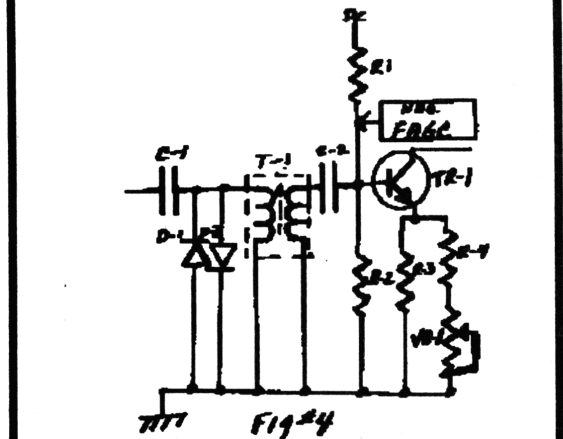
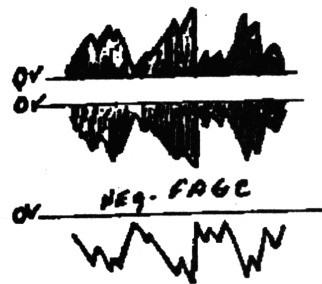
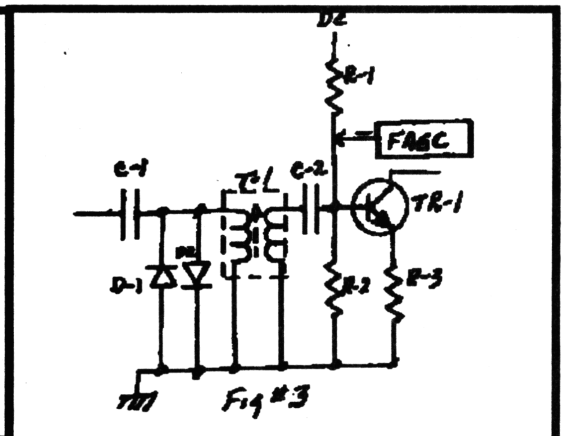

FIGURE# 30.....CIRCUIT OF THE

non-conventional input circuit. Connect a scope to the anode of the diode we have numbered D-3. Set your scope on dc input and .5v/per cm. With no input to the unit the dc level should only be about .1v. Now rotate the RF gain control ccw and watch it climb to near 1v. Now set your RF gain all the way cw, put an antenna on the input and as you receive stronger and weaker signals, watch the voltage rise and fall between these same limits. this can also be accomplished with a meter that has 20k ohms/per volt input but not quite as effectively. Fig. #6 is an actual input circuit, clipped from a Cobra 29LTD schematic. Note the point to test these voltages mentioned above.

### THE 29 IS BACK

We were able to confirm with Dynascan, Cobra div., the rumor that they would soon be reactivating the supplying of Cobra 29LTDs. However, the spokesman for Cobra stated that they would be calling it the Cobra-29LTD Classic. He stated too that the packaging or packing box would carry a picture of a semi-truck in recognition that the American truck-drivers were the prime mover in their decision to reintroduce them. A firm date was not given as to their availability.

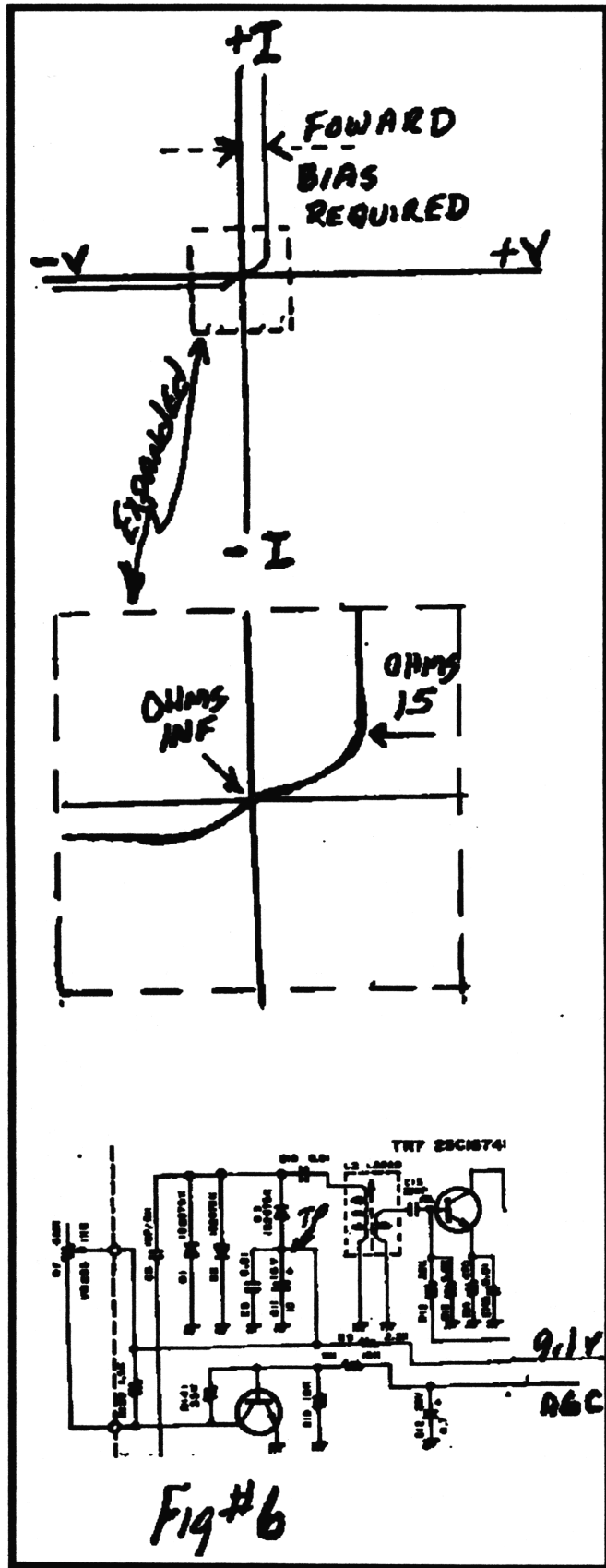

FIGURE# 31.....CIRCUIT OF THE MONTH

## **Unit Evaluation**

### **Unit Evaluation**

---

#### **UNIC-RV-CB45 AM radio**

##### **Short-Comings:**

1. Led signal "s" meter and transmit modulation % meter is good but there is no light or indication of when the unit is switched to transmit.
2. Small dual control knobs.
3. No slug tuning in the driver and final circuit.
4. Grounded case.

##### **Good Features:**

1. Surrated knobs even to a rotating channel selector.
2. Option switching to channels 9 and 19.
3. LC-7131 PLL chip and a TA-7310p vco/mixer chip (this allows for "A" and/or "B" kit modification)
4. Mike connection, a standard 4 pin Midland-type connection.

##### **New Features:**

1. Inductive coupling on the output of the 10.24mhz. Circuit (T-6) allowing for a change in load without a change in frequency.
2. 1st can looks like a 455khz can (very critical tuning).
3. Pin 5 of the vco/mixer chip has fixed tuning (L-2) while there are two tanks on the output pin 9. (T-8 and T-9).
4. There is no tuning on the first 455khz amplifier.

Let us suggest, if you have these units for sale, that you make this first circuit correction in front of your customer. It is a little bit "show biz" but it does instill in your customer your ability and knowledge of this unit in case he should ever need repairs.If you will turn mic-g control completely ccw and press the ptt mike lever, you will see that you have no indication of transmit.

1. Remove the bottom cover.
2. Make up a 3" wire with a 100k resistor on one end. Cover the resistor with shrink tubing.

3. Attach the resistor end to the leg of R-101. (Located just behind pin 2 of the IC-4 chip). Tack the other end to the leg of R-56 (located just forward of L-8 and L-9, outboard from Q-8). Now when you press-to-talk the first two lights on the L.E.D. bar indicator will come on. These are not a transmit level, just an indication. The modulation % will still be indicated above this level. The level of this mod. % is adjustable by RV-3 (located forward of the audio chip but it also adjusts the AMC (automatic modulation control). If this pot is adjusted too much ccw, the unit will over modulate. RV-1 adjust the L.E.D. bar for "s" units. RV-2 squelch level. R-2 serves no purpose in the circuit. Since the collector's source is also removed during transmit, there is no need to ground the emitter. R-1 (an 820 ohm resistor) is sufficient for self-biasing. There is no need to attempt fixed biasing in the emitter circuit. This reduces the amplification factor of this 27mhz amp. Better receiver sensitivity is gained by clipping or removing this resistor.

As for the short-coming of the driver and final not having slug tuning. To peak this unit, half and spread the two halves of L-13 as far apart as the chassis and L-1 will allow. Squeeze or stretch tune L-11 and L-10 for a peaked position. Once you have these coils tuned you might want to put some 3m-4475 adhesive on them to prevent their bouncing up and down. Just drop some adhesive on the top coil opposite sides and let it run down the coils. For those that have their work bench so located, this unit offers a good chance for you to show off your expertise.

### On The Topic Of Circuit Analysis:

From the time of the first feature, we have had a lot of favorable and encouraging comments. But more importantly, the discussion of the circuit has brought to light things that were not mentioned or were not apparent. We were asked by two different readers, "If the diagram that illustrated the equivalent resistance of a diode as you apply voltage from zero to forward conduction were true, why did we infer that the diode offered infinite resistance while the lowest voltage applied was .1 volts?" This did prompt thought and further investigation of the circuit. The findings were that the circuit as designed did not meet the full intent of the original design, but if you add another 1N-914 or 1N-4148 (or any other such fast switching diode) in series with the existing diode it does. The Plus is that the receiver gain is increased and the RF gain control has a wider range of control. Also, this month we have had several calls from persons modifying a President or Uniden AR or



## **Unit Evaluation**

AX-144. They were using the instructions as printed for the Cobra 146GTL. They were having problems finding the points to cut and cross-jumper. The printed circuits for these units are not identical. The best way to find these points on any circuit is to locate the input PC run to L-22 and L-23 (470uh coils). Cut and cross-jumper these runs so that the change only effects these components. The only other exception is that you can include the two switching diodes D-37 and D-38.

### **Modifying The UNIC-RV-CB45 For High Channels**

#### **Using The "A" Kit**

For mounting the two switches of the "A" kit we suggest you use the side next to the channel selector.

1. On the bottom cover, locate and mark a point 1/4" up (toward the lip) from the rear mike holder hole. Mark another point 1/2" to the rear and inline with this point.
2. Punch or drill 1/4" holes at these two points.
3. Replace the cover and mark the center of these two holes on the chassis. Punch or drill these two points.
4. Make up the two switches as indicated on the packing card.
5. Mount these two switches with the spdt most forward.

matching points according to "A" kit insert

*NOTE; To open the circuit between "B" and "B" prime (b') isolate pin 20 of the PLL chip by cutting that PC pad.*

*To open the circuit between "C" and "C" prime (c') leave the leg of C-41 raised that is not attached to pin 4 of the vco/mixer, as you are changing it.*

### **Modifying The UNIC-RV-CB45 For Low Channels Using The "B" Kit**

For mounting the switch and epoxy pack (ep) of the "B" kit we suggest you use the side next to the channel selector and that they be mounted vertically.

1. On the bottom cover, starting with the rear most mike holder mounting hole, measure 1/4" toward the lip and then 1/2" to the rear. Mark this point.
2. Mark another point on the top cover vertically in line with this point and also in line with the cover mounting screw holes front to rear.

3. Remove the covers and punch or drill these marked points to 1/4". Also punch or drill matching holes in the chassis.
4. Make up the SPDT switch as indicated on the packing card.
5. Mount the switch and ep with the switch next to the PC board. Matching points according to "B" kit insert follow instructions or installation printed on the "B" kit card

*Note: Step two part 3. . . PLL vdd is pin 18.*

### **Modifying The UNIC-RV-CB45 For High And Low Channels**

Using the "A" and "B" kits.

For mounting the DPDT switch for the "A" kit and the ep of the "B" kit we suggest that you use the same locationing and punch or drilling outlined for the "B" kit. For mounting the 5k offset SPST switch we suggest that you use the opposite side of the chassis. To find this point you will notice that there is a 1/4" and 1/8" hole in the chassis vertically located. Punch out the 1/8" hole to 1/4". Punch the top cover to coincide with this point, then "v" it out to the lip. This allows the cover to slide down over the switch.

1. Mount the two switches on the "A" kit and wire them according to instructions except the wire marked b.
2. Connect the brown wire of the "B" kit to "B" on the DPDT switch of the "A" kit and mount the "B" kit ep.
3. Follow the instructions for wiring the "B" kit (orange lead goes to pin20 of the PLL).

### **Circuit Of The Month**

It was my intent to continue this discussion from the point in the receiver that I concluded last month, in fact I already had my notes ready when other things of more importance were brought to my attention. I feel that you will be better served if we discuss them now rather than 6 or 8 months from now. They are alignment procedures for the Cobra 21,25, and 29 Plus units, and the AMC (automatic modulation control) circuit for the same units. As long as you have an "s" meter, there are two ways of measuring or indicating the receive signal, enabling you to make fine, incremental adjustment in the tuning of the receiver's tanks.

## **AMC CIRCUIT**

1. Using the "s" meter itself. The top piece of most "s" meters has an etching from you a skew effect as the lines and needle meet in line of sight. This allows for the finest increment of change to be noted.

2. By using a Simpson 260 meter. Using the output and ac positions you can connect this meter to the output of the last 455khz tank and read its output on the 2.5 volt scale. You are able again to detect the peak in tuning of each receiver tank as you tune through the maximum signal. Of course this procedure requires that you convert back to method 1 in order to tune the last 455khz tank because of the loading the meter shown to the output. Much to our regret, the first method has been eliminated from our choices due to the use of the L.E.D. light bar system. There is too much change between interval levels indicated to be of any use. This leaves method number two but again you can not adjust the last 455khz tank while the meter is attached.

So for the new units Cobra 21,25 & 29 Pluses, use a meter on DC mode on the cathode of D-5.

*Note: In the schematic this diode is attached to the emitter of TR-17. In some of the units you will find that it has been moved to the base of the transistor and relocated on the PC side of the board. This point is fine except for making adjustments when the signal is small. For that we suggest the output of the last 455khz tank.*

## **AMC CIRCUIT**

I for one, have never advocated the clipping of the AMC diodes. The reasons are varied and their explanations long. So, if you will take my word for it, "It shouldn't be done."

The new circuit designs of the Cobra 21,25, & 29 Pluses are a little different than previous circuits and deserve an explanation of their functions. If you clip or open the AMC circuit at D-20 the audio amplifier can easily be overdriven. If you are tempted to remove TR-33 or TR-34, please don't and here is why.

If you remove TR-34 the voltage that is applied to the base of TR-33 is too high during receive and will cause damage to the transistor.

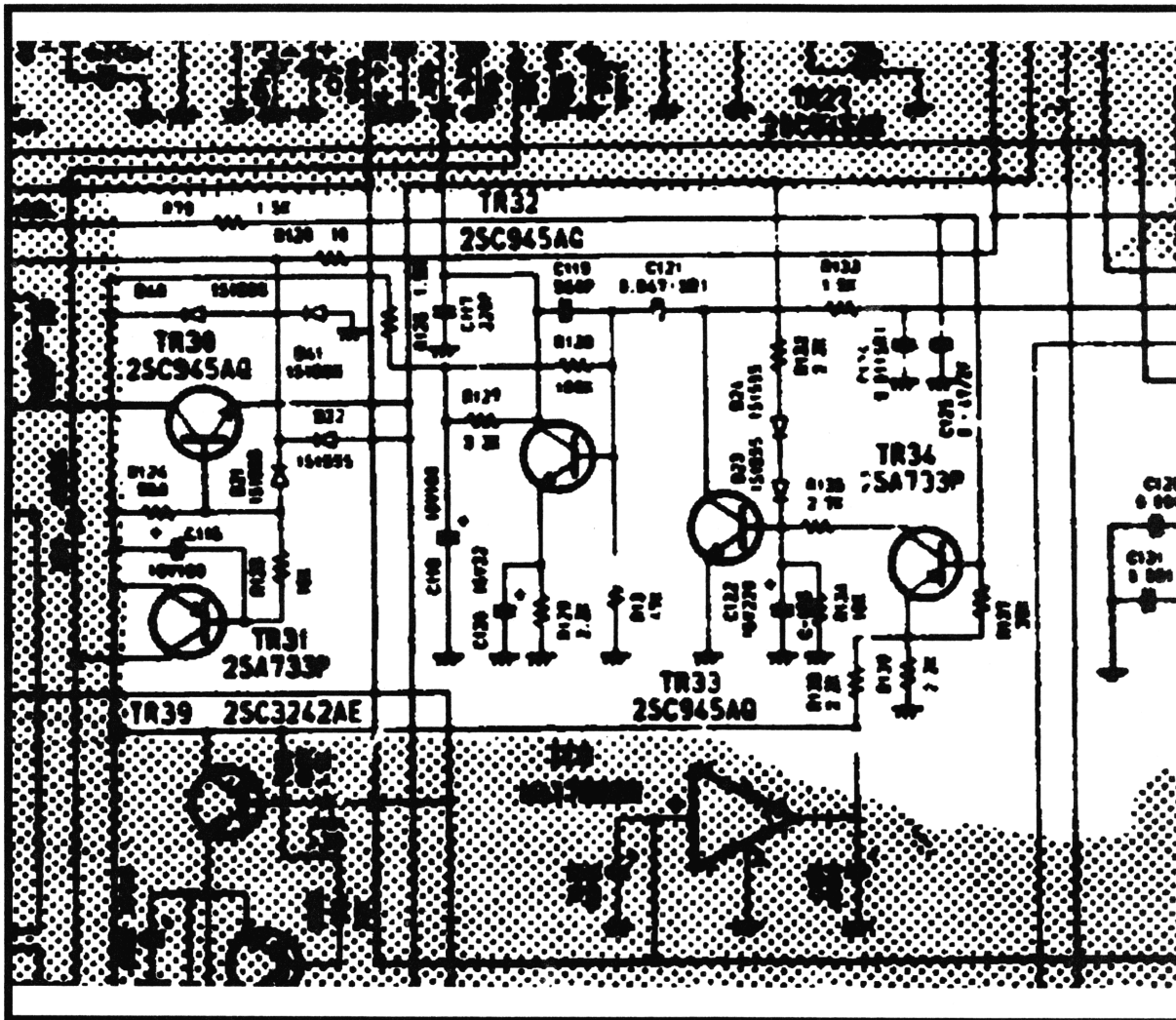

FIGURE# 32.....AMC CIRCUIT

If you will notice, there is 8.1 volts applied at the top of R-132 during receive and not counting base current of TR-33, this voltage would be dropped across R-132, the two diodes D-23 and D-24, and the resistor R-134. The base current of TR-33 will however limit this voltage at the base to about 1 volt. During receive, C-122 (220uf) a very large capacitor, is charged to this voltage. During transmit this charge cannot be bled off to the ground that is applied to the top of R-132, because of the diodes and becomes a source for the collector of TR-34 (a PNP transistor). If it is not there, it must bleed off through R-134 (a 10k resistor). This might cause loading on the first couple words of the transmission.

If you remove TR-33, the effect will be that you have no ground on the mike hi input during receive.

## AMC CIRCUIT

Any RF or noise picked up in the mike cord will be transferred to the amplifier and be fed into the audio amplifier.

*Note: Because this point in the mike is grounded in receive, it is redundant to switch mike HI in the mike itself. This does however, allow you to adapt to these units, a mike that only has ground switching for transmit and receive.*

The second purpose of TR-33 is to act as a variable resistor during transmit. If the mike high causes the audio amplifier to produce audio spikes that reduces the 13.8 volts on the secondary of the audio transformer to below 3.8 volts, the AMC diode will conduct. The lowering of the voltage on the base of TR-34 will cause this PNP transistor to conduct more. This causes the collector of TR-34 to go more positive which is reflected on the base of TR-33. This causes TR-33 to conduct heavier, causing loading of the mike HI signal. The sampling of the audio is made on the negative swing of the voltage which does not chop the positive peaks of the amplitude modulation. (I say "clever").

### How can you change the AMC effect?

Two ways. If you will look at the 25 and 29 schematic you will see R-79. In one case it is on one side of the AMC diode and the other, on the opposite side. It is not important where it is because it is only a circuit limiting resistance. Also notice R-138 and R-139 (2.2k resistors). They set the voltage for TR-34's emitter to 4 volts, which sets the AMC sampling level to 3.8 volts.

Way # 1. Exchange these two resistors (R-79 and R-139). This will lower the sampling voltage to about 2.5 volts and at the same time give more limiting to the current that charges C-125.

Way # 2. Replace R-79 with a 10k resistor. You will find that in some units, this resistor has already been increased from 1.5k to 3.3k. TRY IT, YOU'LL LIKE IT!!!

*Once again I will issue a plea for participation. If you think there is too little information forth coming about things that do and or should interest you, take a good look in a mirror. You will see one of the persons responsible. Have a long talk with him about the things you are not hearing about. I've heard several persons state that they wonder if "SECRET CB" had quit publishing. I have been told by Selman Enterprises that one thing that determines when they go to print is how much material they have received.*

*If you want more information, you will have to become a participant. Your suggestions or ideas do not have to be a startling discovery or a block buster. If you have a question, ask it. Others might have the same question. Remember, if two heads are better than one, think how much better thousands would be.*

**Editors Note:** I'm glad we got to print this plea. I would also like to say something on the subject of your involvement. If you like the kits and ideas that come out of all of these mods, then don't forget to support the companies that bring them to you! I know that most of you can construct your own kits, but why not support the ones that help you? All the kits both Selman and Card Kits offer are not expensive. By buying from them, you're guaranteeing their existance which in turn keeps you supplied with the info you're accustomed to and enjoy. Think about it!!

# **Modifying The Realistic PRO-2004**

---

### **● LESCOMM**

This mod gives the 2004 approximately a 30 channel per second scan rate and an additional 100 channels for a total of 400 channels, and restores the cellular band.

- 1.Refer to page 26 of the service manual if available.
- 2.Locate pc-3 in unit. Turn unit upside down. Pc-3 is in the after right corner.
- 3.Remove cn501 & 502. (Do not pull on the wires!!) leave 503,504 & 505 connected.
- 4.Remove processor shield cover.
- 5.Remove screws holding pc-3.
- 6.Install 1N914b or 1N4148 diodes in the holes etched for D-514 and D-510. (Count back from the labeled diodes.) Remove D-513.
- 7.Locate cx501.
- 8.Flip board towards front of unit and unsolder cx501. Be careful with the wiring!
- 9.Remove cx501 and replace with 10mhz HC18/u.
- 10.Solder new crystal in place and cut off excess leads.
- 11.Remount pc-3.
- 12.Re-install cn501/502, button up and enjoy your work.

**Note:** Some of the units will not function properly at this fast scan speed. Some of the symptoms are; display comes up blank when unit is powered up. Some of the keys do function.(this symptom progressively gets worse as unit warms up.) Priority check function causes the unit to continue scan rather than continue delay on an active channel after checking priority channel.

If your unit has one of the above symptoms, simply replace the 10mhz crystal with a 9mhz crystal.

## On-Off/Volume Beep Control For The PRO-2004

### • LESCOMM

You will need a push/pull on/off 10k pot for doing this mod.

1. Locate cn504 on pc-3 the cpu P.C.board. It is the center connector on the front of the board.
2. Count the pins from "right to left" and locate pin 7. Follow the wire from pc-3 to where it connects to pc-1. Cut it over pc-1 leaving enough room to solder a wire onto each side.

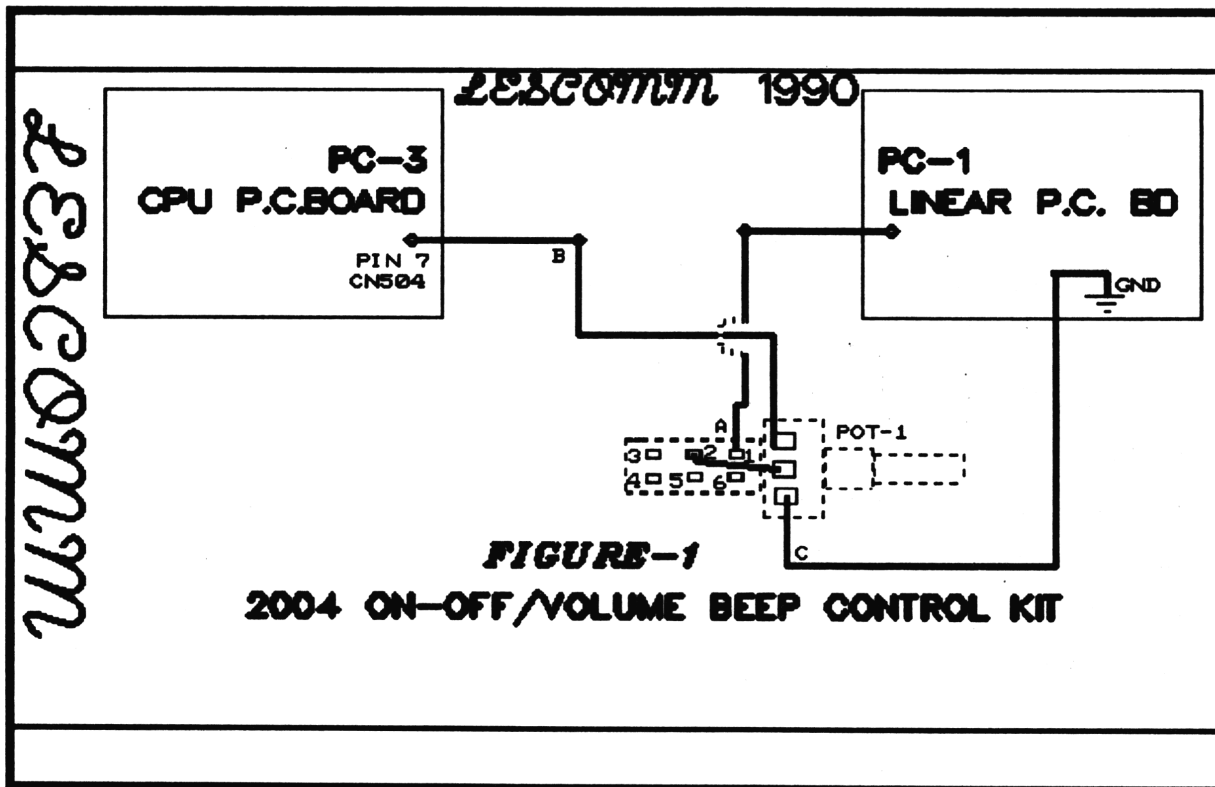

FIGURE# 33.....PRO2004 BEEP VOLUME

3. Drill a 5/16" hole in a convenient spot on the rear panel.  
Remember that your cover takes up some room around the edge of the back panel. Mount the on-off/volume pot in this hole.
4. Connect the wires to the on-off/volume control as diagrammed in figure 33. The wires must be connected exactly as the diagram shows.
5. Turn on the scanner and press the manual button several times as



## Cellular Restore for the BC200/205XLT

turning the volume knob. The beep volume should be going up and down. Next pull out the knob. The beep should be silenced.

*Note: Due to different designs of manufacturers in making these pots, you may need to pull the knob out to turn the beep on. If this is the case, connect wire "a" to pin 3 vice pin 1.*

## Cellular Restore for the BC200/205XLT

---

### • LESCOMM

- (1) Slide off the battery pack and remove the antenna.
- (2) Remove the two screws from the back of the scanner. Also remove the two screws which hold the battery retaining spring at the base and the spring itself.
- (3) Remove the rear cover from the scanner.
- (4) Remove the two small screws from the base of the circuit board. Pull the front panel from the main chassis at the bottom and separate.
- (5) Locate the microprocessor ic labeled "Uniden UC1147". Next locate the 10k surface mounted resistor located above the uprocessor. This resistor is of the round surface mount type, not the flat pack. It is color coded brown/ black/ orange.
- (6) Using a pair of flush cutting pliers, cut the 10k resistor in

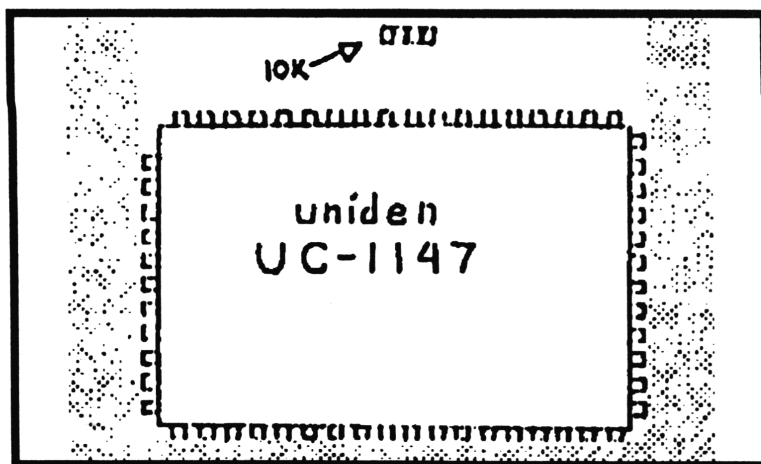

FIGURE# 34.....BC200/205 CELLULAR

two.

- (7) Reassemble unit.
- (8) Switch the scanner on and check the display. If it doesn't come on, check the battery first. If it's ok, the dual in line connector is probably misaligned. Correct and proceed to step 9.

## Modifying The BC760XLT (old version) For Cellular

(9) Try to enter 870.05 into any channel. In just a couple of seconds, 870.05 should come up in the display. Success!

## Modifying The BC760XLT (old version) For Cellular

### ● DON POWERS

*Note, The following instructions require precise cutting.*

It should not be attempted by anyone unfamiliar with electronic components. Performing this modification will void your warranty.

You should also know that it is against the law to monitor telephone conversations including cellular.

(1) Remove the four screws holding the bottom cover and remove same.

(2) Locate the microprocessor ic. It is a large 64 pin chip near the front of the scanner. Pin 1 is marked by a dot.

(3) Locate pin 20. Cut this pin close to the circuit board.

(4) Reconnect power to the radio and program 870.000 into any channel. If "error" does not appear, your work has been rewarded!

(5) Reassemble the unit and enjoy it.

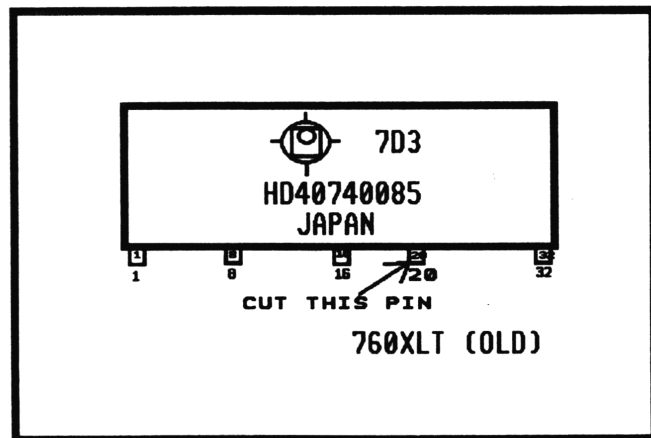

FIGURE# 35.....760XLT (OLD) CELLULAR RESTORE

## Cellular For The New 760XLT And The Regency R1600

### ● LESCOMM

Refer to figure 36.

(1) Remove the four screws holding the bottom cover.

(2) Locate the microprocessor.

## Cellular For The New 760XLT And The Regency R1600

(3) Looking at the solder side of unit, cut the run to isolate pin 26 as shown.

(4) Connect pin 20 to pin 19.

(5) Connect pin 26 to plus vdc pad as shown.

*Note; Do not connect pin 26 to pin 27. Doing so will disable the window detection circuit.*

(6) Remove the resistor behind pin 20 marked as a 472.

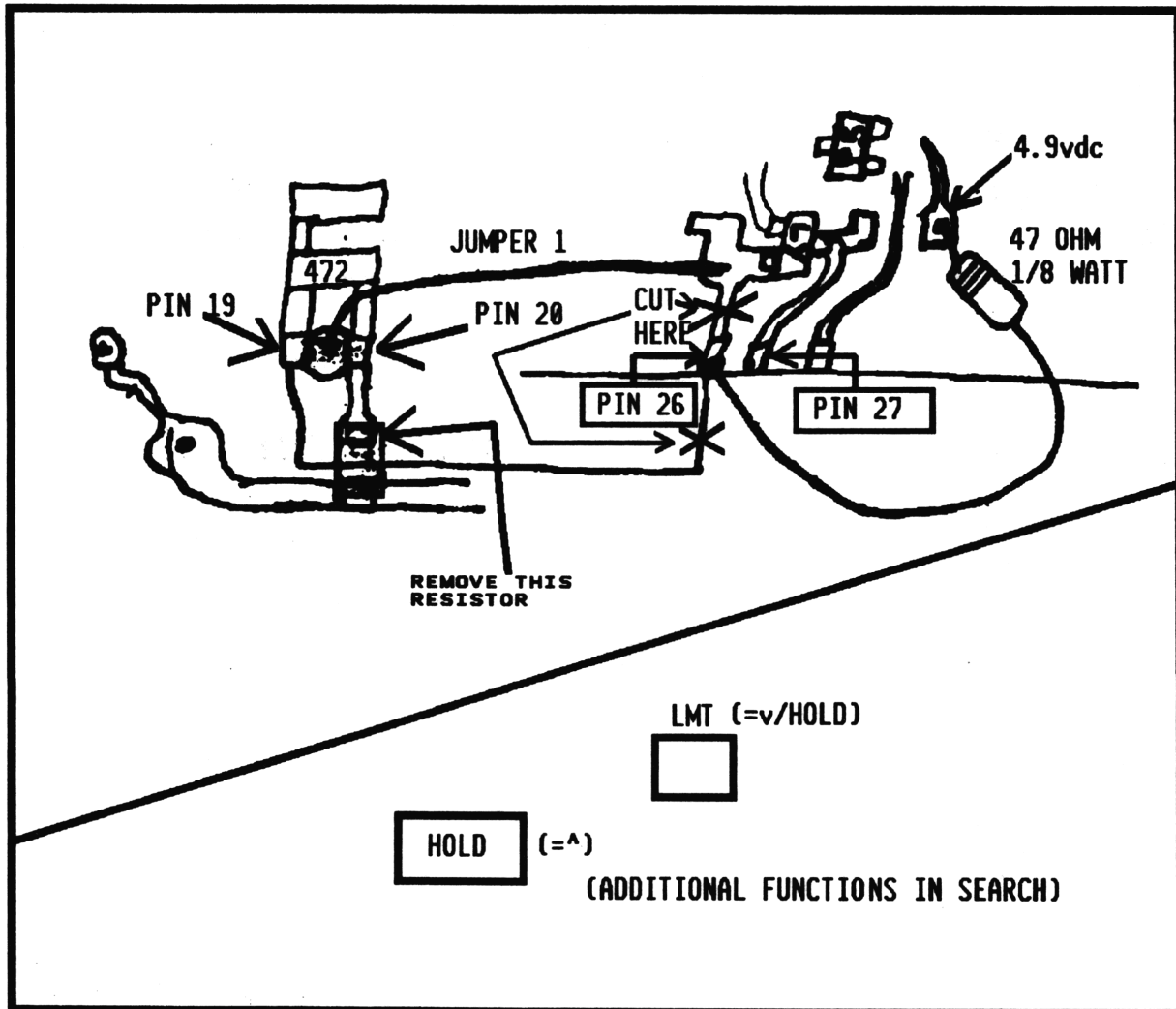

**FIGURE# 36.....CELLULAR FOR THE 760XLT(NEW) & R1600**

(7) Restore the cut run around pin 26 by using a jumper as shown.

(8) Connect power to the radio and program in 870.05 on any channel. If "error" does not appear, reassemble the unit!

## HINTS AND KINKS

### PRESIDENT JACKSON CRAPPY AUDIO

● **Sam, T&S Electronics**

**COMPLAINT:** On AM/FM/SSB, audio raspy, mushy.

**FIX:** Tap C135 (2.5V, 0.22uf), a capacitor in the audio section with a screwdriver while transmitting into a dummy load and listening on another radio. Echo, or microphonics will pinpoint the faulty capacitor.

Replace with one of equal or slightly greater value and greater voltage rating.

I replace these on every new set in a few minutes while doing the receive sensitivity mod and the frequency mod for the local hams. I have seen at least 15 of these caps go west.

### RCI-2900    SIDEBAND    WARBLE    AND    SLOW FREQUENCY LOCK TIME

● **BILL GRASSA**

**COMPLAINT:** Sideband Warble and Slow Frequency Lock Time.

**FIX:** (a) Remove cover screws

(b) Remove small V.C.O. box (shield) cover (4 screws)

(c) Locate R-124 which is a 47k resistor (see silk screen)

(d) Flip radio over and de-solder R-124 (you don't have to remove solder side shields, its in between).

(e) Solder in a "10 ohm" resistor in R-124's place

(f) Replace V.C.O. cover

(g) Turn radio on and check TP-7 for 2 volts at 28.000 mhz (Rec)

(h) Put a scope on TP-5 and adjust for max. (rec)

## **GALAXY II FREQUENCY COUNTER PROBLEM**

### **GALAXY II FREQUENCY COUNTER PROBLEM**

#### **● Terry Shelley**

**COMPLAINT:**Frequency counter chronic problem, L.E.D.'s not Lighting, zener Diode (2.4 volts) failing.

**FIX:**Is the third diode from top middle of board. Increase to 1watt type.(1N47XX)

### **Super Star 3900 FREQUENCY DRIFT**

#### **● Pat Vizenor**

**COMPLAINT:**Radio will drift when cold.

**FIX:**Run a common wire on all cans in the PLL section.(see drawing)

*NOTE: This helps somewhat, not a cure all.*

### **BAD AUDIO FROM BEARCAT 210XLT**

#### **● LESCOMM**

For some strange reason, Uniden engineered the audio circuit slightly different in the BC210XLT from other units. They swapped value differences in the capacitor arrangement, and as the caps get older and start to change value or break down, the audio gets very raspy and scratchy when the volume is turned up. It almost sounds like the speaker has gone bad. But the fix is easy as you will see.

Locate IC2, a TDA1905. Find pin 1 and a 220uf 10v electrolytic right next to it. Remove the 220uf cap and pay attention to the +/- orientation. Locate the external speaker jack and a 47uf cap right next to it. Remove the 47uf 25v electrolytic cap and put in the holes the 220uf was removed from. Put the 220uf where the 47uf was. In other words, swap the two caps. That's it. Your scratchy audio problem should be gone.

# MTC-101

Distributed by:

SELMAN ENTERPRISES, INC.  
P.O. BOX 8189  
CORPUS CHRISTI, TX 78468  
PH (512) 853-2935

Quick check of transmit and receive continuity. Green LED for receive. Red LED for transmit.

Dealer : **\$39.95**

Operates on internal 9 volt battery or external 9 volt dc input.



Speaker enables you to hear the tonal quality as well as the sensitivity of the mic being tested.

On/off volume control.

Mini jack:

Provides a direct input into the audio amp. Good for checking mic cartridges, unwired mics, or audio circuits.

Prewired sockets for easy wire-up/test of mic.

Actual size :

4 1/4" x 7 1/2" x 1 1/4"