

SECRET CB[®]



CONFIDENTIAL
**FACTUAL
REPORT**
SCHEMATICS ETC.

ACKNOWLEDGEMENTS

SECRET CB WISHES TO GRATEFULLY ACKNOWLEDGE THE FOLLOWING PEOPLE FOR THEIR HELP AND CONTRIBUTIONS TOWARD GETTING VOLUME 21 IN PRINT. THEIR ENCOURAGEMENT AND CONTRIBUTION OF MATERIAL HAS BEEN INVALUABLE.

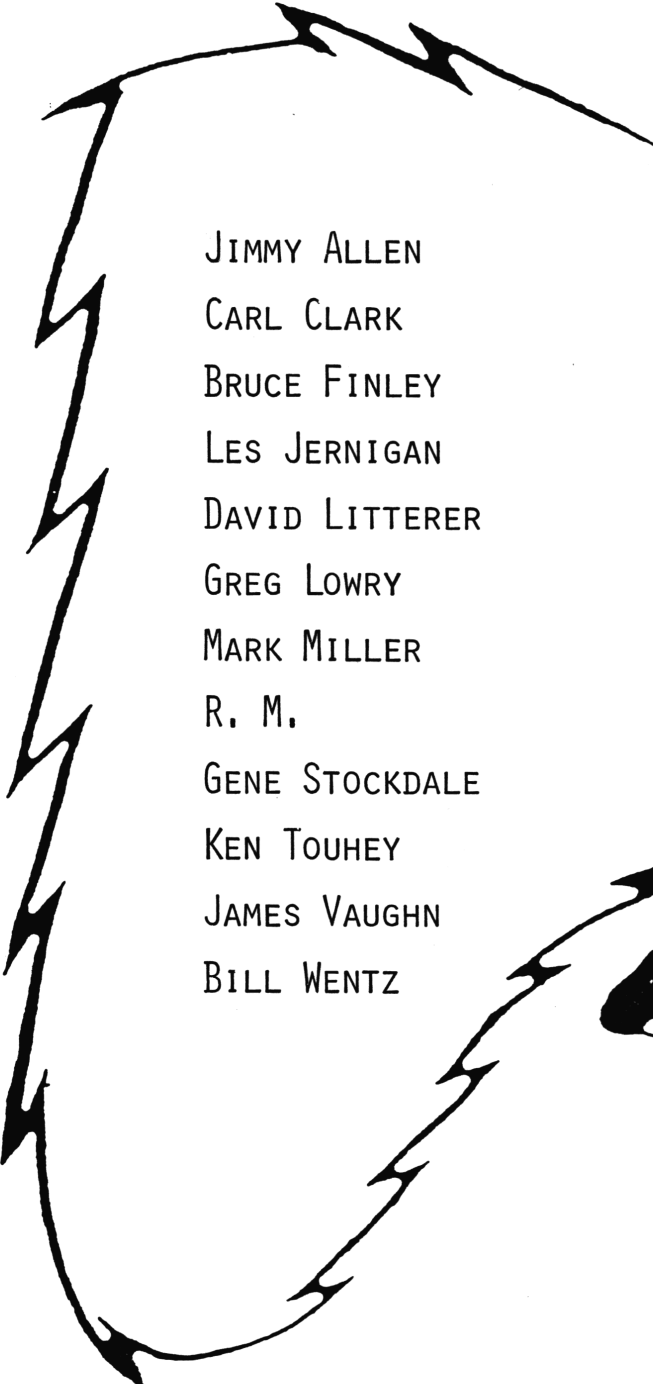

JIMMY ALLEN
CARL CLARK
BRUCE FINLEY
LES JERNIGAN
DAVID LITTERER
GREG LOWRY
MARK MILLER
R. M.
GENE STOCKDALE
KEN TOUHEY
JAMES VAUGHN
BILL WENTZ

WANTED

NEW MODIFICATIONS
NEW CONVERSIONS
TECHNICAL TIPS
PROJECT PLANS
ETC. ETC. ETC.



DORIS SAYS "THANKS" AND A FREE BOOK TO THE ABOVE PEOPLE.

INTRODUCTION

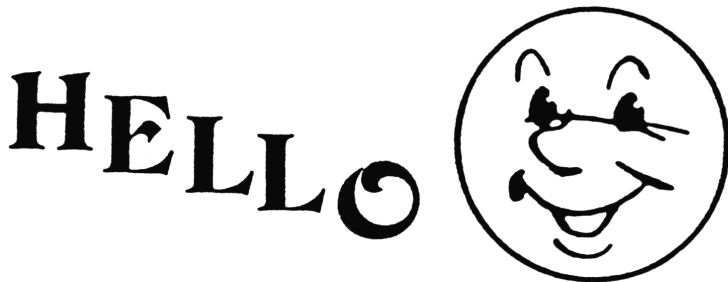

I take pride in introducing our VOLUME 21 of "SECRET CB". Every volume gets better and better thanks to our editor, Bill Wentz, and all of our contributors. I am glad there are still readers out there that encourage us to keep writing "SECRET CB".

We could use more contributors so you guys & gals out there get busy and send in all that good stuff you have stashed away. New material is getting more scarce all the time.

Finally the end has come to the NEC 2SC1307. The Nippon Electric Company has discontinued this item. I must warn you to watch out for the bogus ones that are showing up as C1307. See article on page 7.

We have included a form on page 72 that we would appreciate you using when sending information for use in "SECRET CB". Either cut out the page or copy it which ever suits you best. We would also like to ask that you send in the information and not try to give it over the phone. Then we will contact you if it is necessary for further information.

Any one having extra CB SAMS books for sale let us know and we will pass the word on. We need parts source for the Glen Digital Controller or if you have an old unit that you would sell for parts let us know.

For those who havn't heard there is a nice DX Base available called 'EXCALIBUR' with CW/FM/AM/USB/LSB and a uniden chassis. There is also an AM/FM Base available.

Our NEW PRODUCTS are: Voice Scrambler, Tone Modules, and FM Walkie Talkie. Read about them in this volume.

Have A Nice Day!

Alex Selman

TABLE OF CONTENTS

	PAGE
ACKNOWLEDGEMENTS.....	1
INTRODUCTION.....	2
TABLE OF CONTENTS.....	3-4
CB JAMBOREE INFORMATION.....	5
LETTER FROM THE EDITOR.....	6
NEW PRODUCT RELEASE: TONE MODULES.....	7
MRF-477.....	7
WARNING ABOUT BOGUS 2SC1307.....	7
VOICE SCRAMBLING.....	8
NEW PRODUCT RELEASE: VOICE SCRAMBLERS.....	9
EXPORTS.....	10
EXPORTS; FEEDBACK; RUMORS.....	11
MASTER EXPORT FREQUENCY CHART.....	12
SEARS 663.38100050: Kit 106 INSTALLATION & SLIDE MOD.....	13-16
SECRET CB Kit 106 FREQ. CHART FOR SEARS 663.38100050.....	17
SPECIFIC TUNE-UPS: MIDLAND 77-104; CLARICON 71200; SBE-22CB CATALINA II; GE 3-5804F; COBRA 19XS; UNIVERSE CB747; BROWNING BARON.....	16
10KHz JUMP MOD. FOR COBRA 148GTL-DX & SUPERSTAR 360FM.....	18
HIGH FREQ. MOD. FOR COBRA 248GTL-DX & SUPERSTAR 360FM.....	18-19
MODIFICATION OF THE 'CRYSTAL TYPE' WALKIE TALKIE.....	20
CRYSTAL SET: 'SWAP OUT' CONV. CHART FOR WALKIE TALKIES.....	21
TROUBLE SPOT.....	22
HINTS/KINKS/GOOFS.....	23
PARTS SOURCE: DEMCO RADIO & LINEAR PARTS.....	23
PARTS SOURCE: DAK PARTS.....	23
SAMS CROSS REFERENCE.....	24
CARD-KIT "B" UPDATE (SECRET CB CATALOG ITEM #136"B").....	24
GEMTRONICS GTX-44 FREQ MOD.....	25
DAK MK 9 FREQ MOD.....	25
COBRA 21XLR (858 PLL) FREQ. MOD.....	26-27
YAESU FT-726R FREQ MOD.....	27
TALK BACK.....	27
AX/AR-144 MOD WITH AUTOMATIC 5KHz DROP.....	28-29
5KC SWITCH FOR 858 SSB CHASSIS.....	30
RF GAIN CONTROL FOR '858' GRANT.....	31
SERVICE INFORMATION.....	31
FACTORY "SCREW-UPS" O2A EXPORT PCB's.....	32
XTAL XCB-71 40 CH (TC5080P - DIVIDER!).....	32
UPDATE ON CB & SCANNER MANUALS.....	33
UNIDEN PC-33: CARD KIT "B" INSTALLATION.....	34
SPECIFIC TUNE-UPS: NEW '84 REALISTIC TRC-86 & TRC-208; REALISTIC TRC-208; J.C. PENNEY 981-6221.....	35
SERVICE NOTE ON JACKSON.....	36
PARTS SOURCE: TEABERRY, PRESIDENT & SANYO CB PARTS.....	36
DON'T ASK WHY?- 148GTL-DX (LATE).....	36
ORBITSONIC 200 (NIS7264B PLL) FREQ MOD.....	37
PREVENTATIVE MAINTENANCE/REPAIRING TOP LOADED WHIPS.....	38-39
TROUBLE SPOT - AZDEN PCS2000 (2 METER RIG).....	39
ICOM 720A - TX FROM 1.7 - 30.0MHz.....	39
TROUBLE SHOOTING: TRC-458 (858 SSB) & PRES. ADAMS (858SSB)	40
ERROR IN SAMS CB-176 ON PRESIDENT ADAMS.....	40
JACKSON: AUDIO "DISTORTION/BLARING".....	41
PACIFIC 800 SSB FEEDBACK.....	41

TABLE OF CONTENTS CONTINUED;

	PAGE
GRANT-DX CLARIFIER MOD.....	42-44
DE-BEEP: SUPERSTAR 3600FM/COLT 160DX (EXCALIBUR) 02A.....	44
UPDATE: HORIZON 29A - SCHEMATIC CHANGE.....	45
SALVAGE THOSE BATTERY OPERATED IRONS.....	45
FM WALKIE-TALKIE - DNT HF-12/3.....	46
SCHEMATIC OF FM WALKIE-TALKIE.....	47
SCHEMATIC OF J.I.L.(CITIZEN) MODEL BPL524-77.....	48
SCHEMATIC OF ARGO-300 AM/FM.....	49
ARGO-300 (EXPORT) AM/FM NOTES & TUNE-UP.....	50-51
REALISTIC TRC-414/421A/422A RECEIVE BROADBAND MOD.....	51
STALKER "ELITE" NOTES.....	52
MAJOR M-120 & MARKO CB-144 NOTES.....	52
TROUBLE SPOT - MIDLAND 77-104's.....	52
SCHEMATIC OF COLT 870.....	53
HEATH BATTERY ELIMINATOR MODEL IP-2715.....	54
02A "EXPORT" CHASSIS schematic of ptOS011A0X PCB.....	54
SCHEMATIC OF HAM INTERNATIONAL M788.....	55
SCHEMATIC OF SUPER STAR 2000.....	56
OAK CATV EQUIP "UNSCRAMBLING".....	57-59
VSB-1 UPDATE ON SHARP CB-2460.....	60
SPECIFIC TUNE-UPS: SEARS 23-934-3671160; SEARS 663- 38030050-TC9109BP PLL: G.E. 3-5816A-TC9109BP PLL.....	60
US VERSIONS MB8719/MB8734 PLL CHASSIS FEEDBACK.....	61
TRC-413 TUNE-UP AND ADJUSTMENTS.....	61
SCHEMATIC OF MIDLAND 150M (EXPORT).....	62
SCHEMATIC OF PC 244.....	63
SCHEMATIC OF COBRA 146GTL.....	64
INDEX OF VOLUME 1 THRU 20.....	65-71
CORRECTIONS INDEX.....	68
CONTRIBUTORS FORM.....	72

CORRECTIONS IN THIS VOLUME:

- Vol. 4, pg. 10 - SLIDER STALKER 101/202 - see page 23
- Vol. 18, pg. 16 - YAESU 757GX - see page 27
- Vol. 19, pg. 34 - GRANT-DX (Upper Fo Mod) - see page 34
- Vol. 20, pg. 35 - JACKSON trouble spot - see page 27
- Vol. 20, pg. 40 - GRANT-DX (Fo Mod) - see page 18
- Vol. 20, pg. 51 - Locator Drawing - see page 16

ASK FOR OUR "SECRET CB" PRODUCT CATALOG.

**VOTING FOR 1986 NATIONAL
TOP 20 AT 2 P.M. SUN.**

National Top 20 Jamboree

JUNE 28 • 29 • 30 • 1985
DARKE COUNTY FAIRGROUNDS
GREENVILLE, OHIO

9:00 A.M. FRIDAY — 5:00 P.M. SUNDAY

CHURCH SERVICE
 9:00 A.M. SUNDAY
 By Popeye

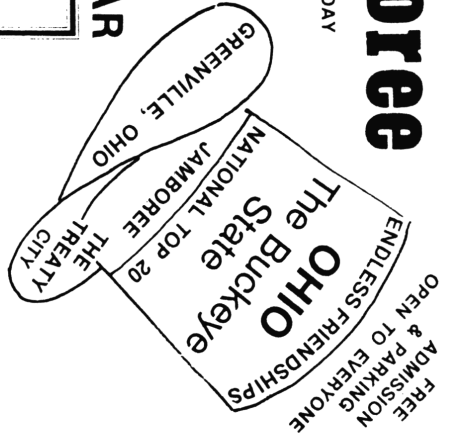

GRAND PRIZES

100% PROFITS TO CHARITY

(Need Not Be Present To Win)
 \$1.00 Each or 6 for \$5.00

FRIDAY NIGHT
 HOSPITALITY ON FAIRGROUNDS 7TIL

SATURDAY
 1st Prize \$500.00
 2nd Prize President Washington AM-SSB Base Radio
 3rd Prize? ? ?
 4th Prize ? ? ?

PIG ROAST
KIDDIE TRACTOR PULL
HORSESHOE PITCHING
DANCE

SUNDAY
 1st Prize \$1000.00
 2nd Prize Microwave Oven donated by Shaw's CB Sales, Kentucky

SATURDAY NIGHT
King & Queen
Dinner Dance
 \$5.00 per person

CHILDRENS GRAND PRIZES
 1st Prize ? 2nd Prize ?
 3rd Prize ?

for dinner and dance
 Steak or Chicken, B. Pot.
 G. Bean • Salad • Dessert
 Roll and Coffee
Moose Lodge
 across from fairgrounds

DOOR PRIZE TICKETS
 5 for \$1.00
 30 for \$5.00
 70 for \$10.00

Preferable to change money at Canadian Border. Canadian money will be accepted at bank rates at time of Jamboree

NOT RESPONSIBLE FOR ACCIDENTS OR LOSS

M.C.S.
POPASAN & PITTER PATTER
POPEYE

Booth Displays
 by Invitation Only

Display Ads,
 Handies, Club Ads,
 Flyers or Business
 Mail To:
 ALICE BARTON
 525 E. 4th Street
 GREENVILLE, Ohio 45331

LOTS OF FREE THINGS
 TO SEE AND DO
 ALL ENTERTAINMENT
 DONATED

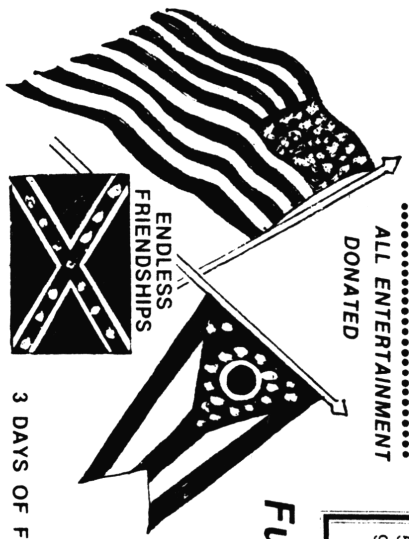

3 DAYS OF FUN — FUN — FUN

NEW THIS YEAR

ENTER NOW
1985
BOTH KING & QUEEN CONTEST

National Top 20 King & Queen will reign until 1986. Entries each club will be accepted. Prizes for Both

FOR INFORMATION CONTACT:
 ALICE BARTON
 528 E. 4th ST.
 GREENVILLE, OHIO 45331
 513-548-3889
 9:30 A.M. FRIDAY —
 DEADLINE APRIL 1, 85

Fun For Everyone!

CAMPING ON
 GROUNDS \$10.00 NIGHT
 ELEC. & WATER HOOK-UP
 500 SHADED SITES
 HOTEL RESERVATIONS
 SEE REVERSE SIDE

21 Trophies:

- (4 min on club)
 Largest Club — 1st, 2nd, 3rd
 Farthest traveled — 1, 2, 3, air miles Best Dressed — 1, 2, 3
 3. Best Club Banner — 1, 2, 3
 Oldest Male & Female with proof. Best Dealer Display — 1, 2.
 Farthest Traveled Individual — Largest Club Cash Donation
 Largest Ticket seller
 Farthest camping group
 Farthest Camper
 Books Close at 3:00 P.M. Sun.

Host Clubs

- TREATY CITY WARRIORS
 TIPP CITY — TIPP CITY,
 OHIO — PRICE HILL —
 CINCINNATI — WRANGLERS — CHILCOTHE.
 PIKE RUN — NEW PHILADELPHIA—CHICKEN
 CHOCKERS — DAYTON

NO ALCOHOL AT JAMBOREE

Printed by permission of Alice Barton.

Please send your information for SECRET CB to Selman Enterprises and would appreciate your using the Contributor Form in the back of this volume. Don't call me at home on Secret CB business. I will contact you if necessary after going over the information. Thanks a lot for your help and cooperation.

OFFICE HOURS

OPEN Most Days About 9 or 10
Occasionally as Early as 7, But SOME DAYS
As Late As 12 or 1.
WE CLOSE About 5:30 or 6
Occasionally About 4 or 5, But
Sometimes as Late as 11 or 12.
SOME DAYS OR Afternoons, We
Aren't Here At All, and Lately
I've Been Here Just About All The Time,
Except When I'm Somewhere Else,
But I Should Be Here Then, Too.

As for claims by people that they have the only Service Manual for certain units? Lets do away with one very quick — below is front cover page for the Cobra 148GTL-DX (Late and Early Versions)..FACTORY SERVICE MANUAL.....

SERVICE MANUAL
SERVICE MANUAL

SERVICE MANUAL
148 GTLDX
(EARLY & LATE VERSIONS)

NEW!
"EXPORT" RADIO
SERVICE MANUALS

UNIDEN 26-page book includes PB010 chassis (COBRA 148GTL-DX, SUPERSTAR 360), PC999 (GRANT), and PB042 (JACKSON) in one complete book. Also applicable to Stalker 9FDX export, and American AR-144 type chassis. Written by Lou Franklin, this is the only service manual in existence. Complete specs, voltage measurements, stage gain measurements, theory including detailed PLL description, complete alignment instructions and layouts, block diagram. Special addition describes modifications and improvements for each chassis. Large 11" x 17" schematics for each chassis.

CYBERNET 24-page book includes PCMA001S, PTBM125A4X, PTBM 131A4X, PTBM133A4X. Covers: Colt 1600DX, 2000DX, 2400FM, Falcon 2000, Ham International Multimode III, Jumbo III, MyGain 8795 (V), Lafayette 1800, 2400, Midland 7001 export, Mongoose 2000, Nato 2000, Pacific 160, Lafayette 2400, Starfire DX, Superstar 2000, Tristar 777, 797, Thunder 2000. Written by Lou Franklin, this is the only service manual available for these radios. Complete specs, voltage measurements, theory, PLL charts, alignment instructions and layout, block diagram. Large 11" x 17" schematics.

\$15.00 EACH OR \$25.00 FOR BOTH MANUALS.

STALKER IX (ST9FDX) COMPLETE SERVICE MANUAL FOR BOTH EARLY & UK MODELS.
\$10.00 WRITTEN BY L.R. JERNIGAN.

CB RADIO SPECIALTIES
INCREASE CHANNELS, RANGE & PRIVACY!

1 THE "NONDUALIVER EXPORTS" GUIDE (To Peeking Out & Replacing CB Radio) by LOU FRANKLIN
The most popular "big dummy" guide ever published on do-it-yourself CB repairs & modifications. Covers packing of receivers, transmitters, modulation, noise problems, antenna & SWR problems, detailed frequency modifications for crystal & PLL radios, loaded coil charts, illustrations, special instructions for most brands including the new "export" models. This newly revised 1978 NATIONAL EDITION also includes the latest slider and broadbanding tricks! \$14.95

2 THE CB PLL DATA BOOK by LOU FRANKLIN
The only complete reference source to CB PLL synthesizer circuits ever published. Includes 100+ newly revised & updated PLL circuit diagrams, IC pin-outs, IC data sheets, and the most popular U.S. & "export" radio PLL specific listings. PLL chip ever made. Covers all the most popular U.S. & "export" radio PLL specific listings. All models using the chip. Must reading for the serious CB hobbyist! \$14.95

SPECIAL! Both \$29.90

ROGER "K"; ROGER - 5 Tone; ROGER CHEEP

These 'tone' modules are internally connected to your present transceiver. Can be used on any AM/FM/SSB unit; installation of module is simple; and directions are very well written/diagrammed.

Roger 'K' and Cheep have no adjustment. Roger - 5 Tone; has 7 adjustments: Output Level, Speed Control (controls the speed of tones), and individual adjustment of the 5 tones.

All units have the same installation/hook-up and do have a Disable/Kill wire for hooking up to a switch (not provided).

* * * * NO PROBLEMS should be encountered with this new module, as manufacturer went to great lengths to print very good installation and wiring diagrams. * * * Available at Selman Enterprises.

NOW IN STOCK

In Quantity, the MRF-477 RF Final - for the JACKSON (EXPORT).

!!WARNING!!

THE NEC 2SC1307 has been discontinued. There are some floating around with C1307 stamped on them, which we found to be 2SC1974. Held at a certain angle it could be seen. The 2SC1974 is rated 15W 2A and 2SC1307 is rated 25W 8A. The one we checked blew up. ECG-236 is direct replacement.

SUPER STAR

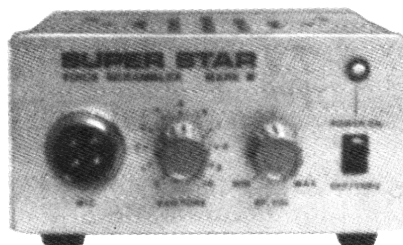

VOICE SCRAMBLER MARK I

Voice Scrambling

by B.W.

What is it? - O.K., "Very" simply: "Altering the signal so that it is unintelligible. With proper equipment this is reversed, and signal is clearly restored." WHY ? - Privacy, Security, etc.

Voice scramblers are now available for the C.B./Ham/etc. market at a very reasonable cost. The industry giants have been shot down again by the people across the water!

These units might be F.C.C. legal, as are not installed into a unit. Installation is between original microphone and transceiver for transmit of 'scrambled audio'. Transceiver's EXT SPK jack is used to descramble the audio.

Typical hook-up diagram below:

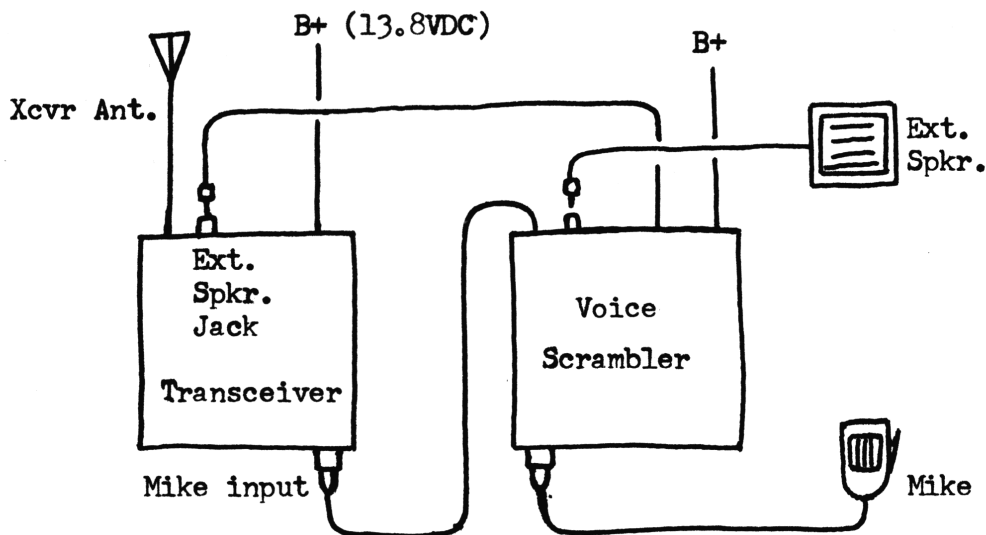

TYPICAL HOOK-UP ONLY

Have 'paperwork' on two of the three units that are out there; on-the-market! These are called: SuperStar Voice Scrambler Mark I, and Zest Voice Control VC-100.

As more of these units become available and have access to, will do an in-depth write-up on each.

Voice Scramblers

SuperStar Voice Scrambler Mark I: (4-wire hook-ups)

This is by far the most professional and easiest on the billfold of any scrambler. A "PAIR" of these will set you back around \$125. There is no schematic available and WILL NOT BE, straight from the "hoss'es mouth"!

CAUTION: These unit's are sold as-is, and if you are not adept at figuring out the microphone wiring modifications - DON'T CALL! OUT-OF-THE-BOX; will plug into Major M-120/A and work with no problem. (Didn't have time or units available to check any other out.)

READ DIRECTIONS CAREFULLY: Are well written in the literal translation, drawings are good also.

* * * * *
SuperStar Voice Scrambler Mark IA:

These units are the same as the Mark I; have been 'modified' for direct hook-up; to the following units: Jackson-DX, Grant-DX, Stalker 9FM, Stalker 9FMDX, Cobra 148GTL-DX (Early & Late), and the SuperStar 360FM. These are about \$10 apiece higher each or \$15 in a set of two. A better buy if you don't know what you're doing!

* * * * *
Zest Voice Control VC-100: (4-wire hook-ups)

This is the unit for 'the man who needs everything'. (EXCUUSE ME, or 'Woman) Unit has the following: Voice Scrambler, Echo Box, Speech Compressor, or straight thru function. Also has Roger Beep or two different melodies that can switch in to 'sound-off' when you un-key.

NOTE - double check with your dealer when ordering - does it come with microphone interconnect cable? If not will have to buy.

The price on this unit (EACH) will have you eating beans for a while! About \$225,BUT ... everything is there: Voice Scrambler; Echo Box; Voice Compressor; Roger Beep; 2 'Tunes' - good directions, and comes with Block Diagram.... NO SCHEMATIC...

EXPORTS

Palomar 1200, 120 Ch. AM/FM, 26.515-27.855MHz (IC7120-PLL): Wrong schematic comes with this unit! Unit has 3 different power ranges, similar to the Tristar 727. Tx Tune-up: L8, L9, L10, L12, L15, and L16. Adjustments are as follows: VR1-RF Mtr, VR3-S Mtr, VR10-FM Deviation, VR11-(.5W AMC), VR12-5W AMC, VR13-10W AMC, VR14-5W Pwr Adj, VR15-(.5W Pwr Adj). Defeat if needed is Q14. RF Final is 2SC1969? If someone comes up with correct schematic, send in for files.

Colt 870, 120 Ch. AM/FM, 26.515-27.855MHz (02A-PLL): Basic 2-Xtal 02A chassis with FM and Xtal switching boards added. Tx Tune-up: T3, T4, L7, L11, L12. Adjustments: RV1-Sq Rng, RV2-AMC, RV3-S Mtr, RV4-Tx Mtr, RV901-FM Deviation. Overall is similar to Major M-120 and Marco CB-444, Good Unit!

FEEDBACK

Falcon 2000: 3 Xtal Mux 02A-PLL Chassis - Identical to the Palomar 2400, see for specs...

Commtron IV, 40 Ch. AM/FM, 26.965-27.405MHz (IC7131-PLL): 'Regular C.B.' Frequencies in this unit - a waste. Owners Manual has everything in it, including the line-up procedure/board layout/schematic. Not much to say about this unit...

Colt Excalibur SSB - Mdl. 160DX, 160 Ch. AM/FM/SSB, 26.515-28.305MHz, 02A-PLL, Direct Switch Chassis: Deluxe Base Station - External is almost identical to old U.S. version; internally is 4 Xtal switching 02A-Chassis. You name and it almost has it! - SWR Mtr, RF/Mic Gain, TX/RX Clarifier with +5KHz, TUNE control separate for RX Fo shift, Fo Counter jack in back for TX Fo only, Recording output jack (records both TX & RX). Also has Select Call feature, if you can find the plug-in. Dual-switchable antennas, Hi/Low Output Power control, Roger Beep-always ON. Manual is EXCELLENT... Has complete line-up, theory, schematic, parts list! **CHECK BEFORE PURCHASING:** Power Transformer, make the Dealer or Distributor change to 110V, if not already changed - as these units came with 220V Xfmr. These units are supposed to be going in the \$400+ price range.

SuperStar 3600, 160 Ch. AM/FM/SSB/CW 26.515-28.305MHz. Need some additional information... PLL type/schematic. This unit is supposed to be physically identical to Cobra 148GTL-DX/SuperStar 360FM. Reports are coming in that is highly modifiable unit, especially in frequency range.

Stag 357, 40 Ch. AM/SSB 26.965-27.405MHz (IC7120-PLL): This unit is not an 'Export'. Just a unit that was made for the U.S. market, but for one reason or the other didn't get on the market. (Probably couldn't pass F.C.C. acceptance test). Any-Hoo, are out now - for what it's worth. Owner's Manual does contain the schematic. The PLL chip is modifiable, see Robyn SB540D (SCB Vol 7) for possible identical modification. Slide modification is identical to 858SSB chassis. For those who experiment and are familiar with unit, basically an 858SSB chassis with different PLL chip.

EXPORTS

Lincoln 1500, 120 Ch. AM 26.515-27.855MHz (LC7120-PLL): Simple and cheap 120 channel AM mobile rig. Nothing spectacular, rated at 4W RF output. 2SC2078 RF Final, schematic in this volume. Quickie' tune-up is as follows: RV1-RX lamp adj; RV2-TX lamp adj; RV3-Sq Rng adj; R230-AMC...(haven't unit to play with; but defeat is C186; 3.3Mfd/25V electrolytic.) RX alignment: T1, T2, T3, T4, and T4 again - as two T4's in this unit? TX alignment: T8, T9, and T10.

FEEDBACK

Cobra 148GTL-DA ... ? (Fake unit; is really a Cybernet chassis; IDENTICAL to the Palomar 2400-another O2A chassis.)

Colt 444, 120 Ch. AM/FM 26.515-27.855MHz (uPD2810-PLL): Identical to the Tristar 727 with the only exception being a lower frequency range. Use schematic/tune-up in Vol. 19 for information.

Midland 150M (Export), 80 Ch. AM 26.965-27.855MHz (LC7120-PLL): Identical to Midland 2001 (Export), with exception of Fo range. See Vol. 19 for line-up. Schematic is printed in this volume.

DNT Md1. HF-12/3; 3 Ch. FM Only - Walkie-Talkie: (U.K. FM CB Band). Comes with Chnls 7, 14, and 19 of U.K. band installed. Good Owner's Manual, parts layout, and schematic. See write-up/schematic this Vol.

ARGO 300, 240 Ch. AM/FM 26.065-28.755MHz (O2A-PLL): 'No name on faceplate or I.D. of any kind on unit'. This unit has a 'new' O2A AM/FM board, everything is on one PCB, not on two or three extra small ones. See write-up/tune-up/schematic this volume.

THAT IS ALL INFO - UP TO PRESS TIME..... RUMORS BELOW.....

Excalibur ? ? ? ; another Export base unit AM/FM/SSB - Jackson specifications as to RF Power, PLL Chip, and Fo's. Heavy-Duty power supply is also supposed to be in this one. (An underground source is already bragging HE has all one hundred coming into the country....get the shovel out again!)

Jackson ? ? ? ; another version - no specs as yet, but is supposed to have a built-in Voice Scrambler and FINALLY - - - Select Call will be available!!!

The Lafayette DynaCom 40 (40 Ch. Walkie-Talkie, O2A PLL chip) is supposed to make a re-appearance on the market as a 120 Ch. unit. This would make a good present even without the extra 80 channels, as is not that hard to modify.....

RUMOR: There is a Satellite TV De-Scrambler out for X-rated channels by the underground. Approx. Cost \$600.00.

MASTER EXPORT FREQUENCY CHART

A-Band		B-Band		C-Band		D-Band		E-Band		F-Band	
Channel	MHz Frequency	Channel	MHz Frequency	Channel	MHz Frequency	Channel	MHz Frequency	Channel	MHz Frequency	Channel	MHz Frequency
1	26,065	1	26,515	1	26,965	1	27,415	1	27,865	1	28,315
2	26,075	2	26,525	2	26,975	2	27,425	2	27,875	2	28,325
3	26,085	3	26,535	3	26,985	3	27,435	3	27,885	3	28,335
4	26,105	4	26,555	4	27,005	4	27,455	4	27,905	4	28,355
5	26,115	5	26,565	5	27,015	5	27,465	5	27,915	5	28,365
6	26,125	6	26,575	6	27,025	6	27,475	6	27,925	6	28,375
7	26,135	7	26,585	7	27,035	7	27,485	7	27,935	7	28,385
8	26,155	8	26,605	8	27,055	8	27,505	8	27,955	8	28,405
9	26,165	9	26,615	9	27,065	9	27,515	9	27,965	9	28,415
10	26,175	10	26,625	10	27,075	10	27,525	10	27,975	10	28,425
11	26,185	11	26,635	11	27,085	11	27,535	11	27,985	11	28,435
12	26,205	12	26,655	12	27,105	12	27,555	12	28,005	12	28,455
13	26,215	13	26,665	13	27,115	13	27,565	13	28,015	13	28,465
14	26,225	14	26,675	14	27,125	14	27,575	14	28,025	14	28,475
15	26,235	15	26,685	15	27,135	15	27,585	15	28,035	15	28,485
16	26,255	16	26,705	16	27,155	16	27,605	16	28,055	16	28,505
17	26,265	17	26,715	17	27,165	17	27,615	17	28,065	17	28,515
18	26,275	18	26,725	18	27,175	18	27,625	18	28,075	18	28,525
19	26,285	19	26,735	19	27,185	19	27,635	19	28,085	19	28,535
20	26,305	20	26,755	20	27,205	20	27,655	20	28,105	20	28,555
21	26,315	21	26,765	21	27,215	21	27,665	21	28,115	21	28,565
22	26,325	22	26,775	22	27,225	22	27,675	22	28,125	22	28,575
23	26,355	23	26,805	23	27,255	23	27,705	23	28,155	23	28,605
24	26,335	24	26,785	24	27,235	24	27,685	24	28,135	24	28,585
25	26,345	25	26,795	25	27,245	25	27,695	25	28,145	25	28,595
26	26,365	26	26,815	26	27,265	26	27,715	26	28,165	26	28,615
27	26,375	27	26,825	27	27,275	27	27,725	27	28,175	27	28,625
28	26,385	28	26,835	28	27,285	28	27,735	28	28,185	28	28,635
29	26,395	29	26,845	29	27,295	29	27,745	29	28,195	29	28,645
30	26,405	30	26,855	30	27,305	30	27,755	30	28,205	30	28,655
31	26,415	31	26,865	31	27,315	31	27,765	31	28,215	31	28,665
32	26,475	32	26,875	32	27,325	32	27,775	32	28,225	32	28,675
33	26,435	33	26,885	33	27,335	33	27,785	33	28,235	33	28,685
34	26,445	34	26,895	34	27,345	34	27,795	34	28,245	34	28,695
35	26,455	35	26,905	35	27,355	35	27,805	35	28,255	35	28,705
36	26,465	36	26,915	36	27,365	36	27,815	36	28,265	36	28,715
37	26,475	37	26,925	37	27,375	37	27,825	37	28,275	37	28,725
38	26,485	38	26,935	38	27,385	38	27,835	38	28,285	38	28,735
39	26,495	39	26,945	39	27,395	39	27,845	39	28,295	39	28,745
40	26,505	40	26,955	40	27,405	40	27,855	40	28,305	40	28,755

SEARS ROADTALKER Mdl. 663.38100050: KIT #106, 26.515-27.855MHz
by B.W.

This particular unit is throwing people on the proper kit installation and 'slide' modification. There is no SAMS available on this unit - but Cobra 146GTL is close. Due to construction of front panel on a separate PCB it is advisable to do the 'slide' modification first.

Following procedure is for installation of Secret CB Kit #106 in Sears RoadTalker Mdl. 663.38100050, ONLY..

KIT-106 for Sears Roadtalker Mdl. 663.38100050, uPD2824C chip-ONLY.
Installation instructions and 'Slide' modification

Due to the front panel construction it is advisable the 'Slide' modification be performed first. Also change the insulators on Driver/Final to thin MICA type. Correct fuse for this unit is 4 Amp - Fast Blow. NO SAMS is available - use Realistic TRC-451 or Cobra 146GTL schematics as both are close. **FACTORY SCHEMATICS ARE LOUSY!**

SLIDE MODIFICATION....Sears 663,38100050 ONLY...

1. Follow diagram below and make two (2) cuts on front panel PCB etch directly behind the Fine Tuning Control... Use VOM to double-check that the etch is cut:

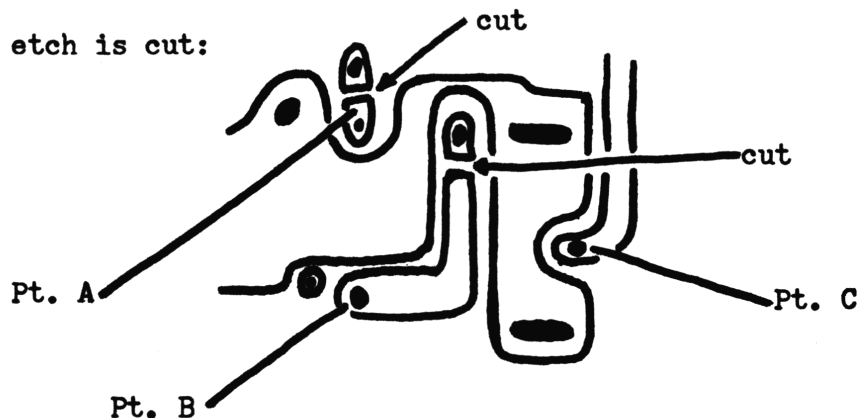

Pt.s A & B are outer terminals of the Fine Tuning Pot, Pt. C is the center wiper.

Slide Mod. - Cont.

2. Run wire from Pt A to D50 (7.5VDC Zener Diode) - located next to 2SA473 and Audio Chip. Solder to leg or diode on component side, or do it right and solder to etch on reverse side of PCB. See below.....

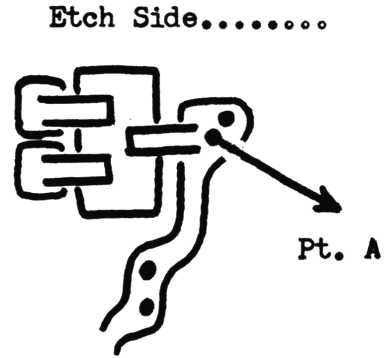
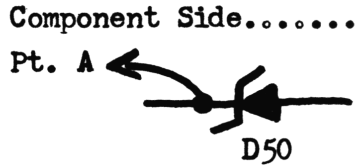

3. Run wire from Pt B to D.C. Ground. (Use the etch side of PCB, next to the shield is perfect.)
4. Remove D32, no replacement.
5. Remove R122 (15K), no replacement.
6. Remove D³¹~~32~~, replace with solid buss wire.
7. Check slide, should be approximately -2.3, +1.8KHz.
8. Replace D30 with a 'Super Diode', slide should be around -2, +8KHz.

KIT INSTALLATION

1. Kit will mount on left side of chassis next to PLL chip. Mounting is optional, in two different places: Enlarge one of the holes and use it or use existing mike hole and change to large washers.

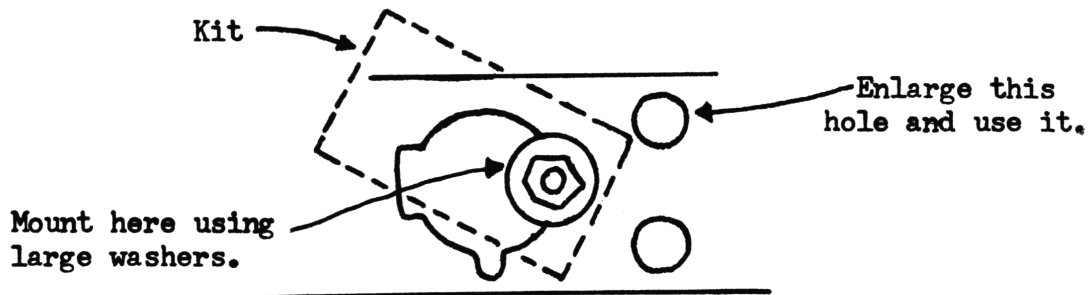

Kit 106 - Sears Roadtalker 663.38100050 (Cont.)...

Kit Installation (Cont.)..

1. Cont...suggest mounting in the microphone hole. This way a small amount of each cover will only have to be removed, and hard to mess it up. The other way can mess it up very easy, if you aren't familiar with metal working! **DON'T MOUNT THE KIT YET..**

2. Kit wires go to the following locations:

Brown - See 'Slide', Step #1. Solder to Pt. C

Black - Solder to DC Ground. (There is a hole to right of L14; can be used for this purpose; as at DC Ground.)

Red - Solder to switched 13.8VDC line. See drawing below:!

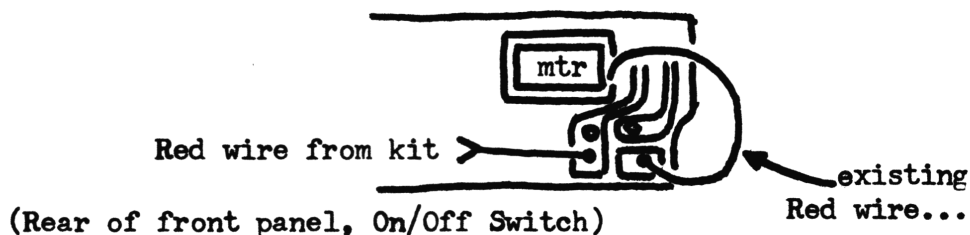

White - Solder to C72, side closest to L13.

* The 2 crystals in this kit will require 2 VARIABLE CAPS (3-13pf) for frequency adjustments. cut trace between each crystal and the switch and solder in caps.

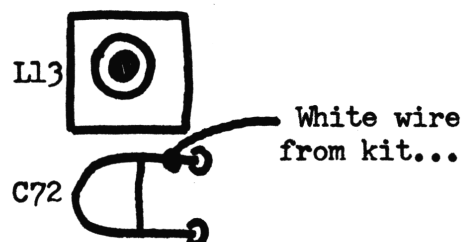

* Special Notes on Installation: may be necessary to shield top of L13 and Kit (Xtals) to keep parts from shorting to case ground.

3. Install the White wire before mounting kit to side of chassis, then do remainder of wiring.

4. Using L13 and L14 at this time try to get the entire frequency range to 'come up'. NOTE: in this unit S/N 13001072 - had to use a 'Super Diode' in the VCO circuit, this is D25. Replace with 'S-D' if you encounter problems with the alignment, will cure the problem.

5. Tune L15, L40, L39, L38, L37, and L28 for overall LINEAR RF Output Power in SSB MODE.

Kit 106 - Sears Roadtalker 663.38100050 (Cont.)...

Kit Installation (Cont.)..

6. Further adjustments are: VR1-S Mtr, VR2-Sq Rng, VR4-Carrier Balance, VR5-AMC, VR6-ALC (SSB PWR), VR7-RF Mtr, VR8-Final Bias, VR9-Driver Bias, VR10-AM Pwr.

7. Measure covers carefully before cutting for the opening!

8. Final configuration of switch on this particular unit is:

Low Fo's - Down; Reg. C.B. Fo's - Middle; High Fo's - Up.

If needed for trouble-shooting and complete 'factory alignment', obtain Realistic TRC-451 (21-1565). Is close to this and very good, just make sure that you receive the large schematic with it - usually not sent with a Zerox'ed manual.

SPECIFIC TUNEUPS

Midland 77-104 (IC7132 - PLL): Small units, perfect for the small cars. Tune L11, and L12 for max forward. Has 2SC2078 Final - most units will tune-up to 6 Watts with 100% modulation, up to 10W forward. RV1-RX LED; RV2-TX LED; RV3-Sq Rng; RV4-AMC (Do not defeat). Rejection isn't that good, do filter mod that was printed in previous volumes.

Claricon Md1. 71200, AND SBE-22CB Catalina II: Tune C162 for max RF on Channel 13; then tune L110, L11, L107, L106, L104 for MAX FORWARD. R152-AMC, R155-Sq Rng.

GE3-5804F: Mod defeat is D-8, unsolder carefully as some units may require that it be replaced.

Cobra 19XS: Remove C253 for max mod only if needed! Will have to put back into the circuit in most units.

Universe CB747: VR7-AMC

Browning Baron: Remove CD36 for additional modulation ONLY if R134 doesn't give enough.

"Printing - Slide?"

Or as old 'Dizzy' would say; 'SLUD'! Seems that page 51 of Volume 20 moved, and locator B drawing didn't have the far right adjustment marked. It is VR13.

Kit #106 (Sears Roadtalker 663,38100050) Fo Chart

<u>Selector</u>	<u>LOW</u>	<u>NORMAL</u>	<u>HIGH</u>
1	26.515	26.965	27.415
2	26.525	26.975	27.425
3	26.535	26.985	27.435
4	26.555	27.005	27.455
5	26.565	27.015	27.465
6	26.575	27.025	27.475
7	26.585	27.035	27.485
8	26.605	27.055	27.505
9	26.615	27.065	27.515
10	26.625	27.075	27.525
11	26.635	27.085	27.535
12	26.655	27.105	27.555
13	26.665	27.115	27.565
14	26.675	27.125	27.575
15	26.685	27.135	27.585
16	26.705	27.155	27.605
17	26.715	27.165	27.615
18	26.725	27.175	27.625
19	26.735	27.185	27.635
20	26.755	27.205	27.655
21	26.765	27.215	27.665
22	26.775	27.225	27.675
24	26.785	27.235	27.685
25	26.795	27.245	27.695
23	26.805	27.255	27.705
26	26.815	27.265	27.715
27	26.825	27.275	27.725
28	26.835	27.285	27.735
29	26.845	27.295	27.745
30	26.855	27.305	27.755
31	26.865	27.315	27.765
32	26.875	27.325	27.775
33	26.885	27.335	27.785
34	26.895	27.345	27.795
35	26.905	27.355	27.805
36	26.915	27.365	27.815
37	26.925	27.375	27.825
38	26.935	27.385	27.835
39	26.945	27.395	27.845
40	26.955	27.405	27.855

WORKS Now!!!

10KHz Jump Modification
Cobra 148GTL-DX/Superstar 360FM, and other similar chassis
by R.M.

Check IC-6 (MC14008BCP), pin 9 should be at DC ground.
Most schematics will show this with no connection or connected to a switch. Switch puts either a Logic 0 or 1 to pin.

This is the 10KHz jump pin — Logic 1 will give the jump!
See diagram below; use the Ch 9 switch after disabling:

1. Remove Jumper JPS4 between IC5 & IC6 ALL
2. INSTALL 4.7K ohm resistor in place of JPS4
3. wire as shown

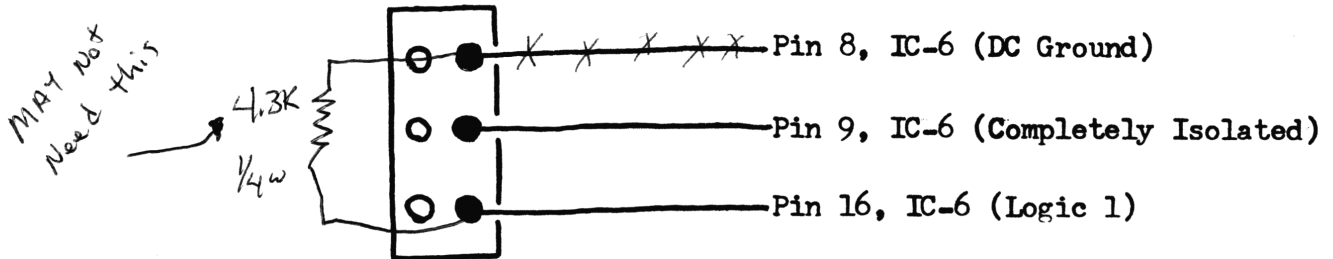

- - H I G H - - Frequency Modification
Cobra 148GTL-DX/Superstar 360FM, and other similar chassis
by R.M.

Had customer that wanted to go way up - so by checking 148DX schematic vs the Jackson, came up with the following mod.

(Note: I used same unit that did the 10KHz modification in. Removed previous switch from chassis and replaced in TONE position, after hard-wiring.) This left empty position where Ch 9 used to be, utilized hole for 4 pole rotary switch.

Caution: before attempting modification make sure that parts will physically fit, and shaft of new switch is knurled to accept the correct knob for matching up I did have to enlarge the front cover hole, but doesn't show after knob is on.

Follow directions - diagrams carefully...

Do not start until you have all the required items!

1. Remove jumper going to Pin 9 of PLL chip - MC145106; isolate completely; was grounded.
2. Run new wire on etch side of chassis from IC7, Pin 14; (there is no connection at present); to Pin 9 of PLL chip.
3. Wire up 4 pole rotary switch as shown; all diodes are 1N914 or similar type.
4. All new frequencies are obtained in the High Band.

H I G H Fo Mod. (Cont.)

Step #1, and #2 Drawing:

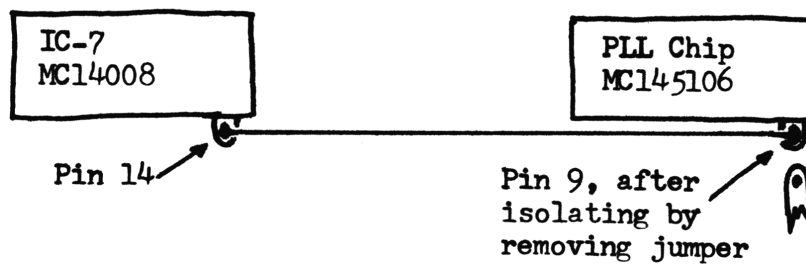

Step #3 drawing:

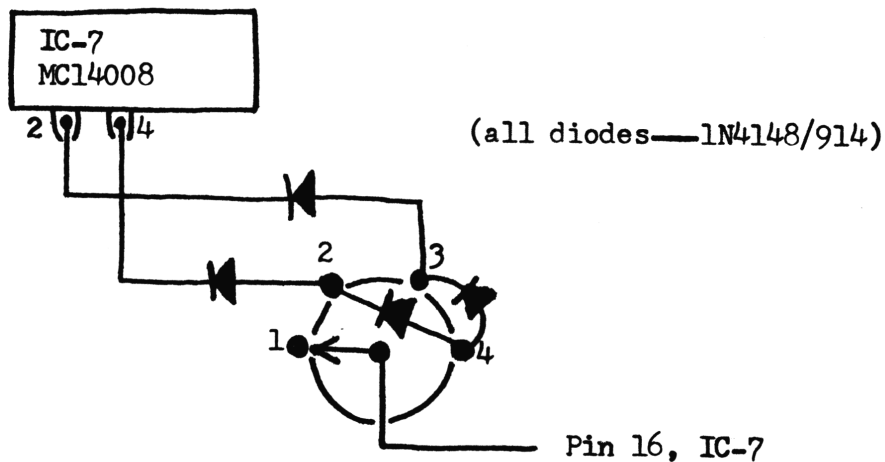

Frequencies HIGH position, rotary switch position:

1. Normal High Fo's
2. 27.875 - 28.175MHz; selector positions 12-40.
3. 28.195 - 28.495MHz; selector positions 12-40.
4. 28.505 - 28.705MHz; selector positions 20-40.

In this particular unit, the VCO - TX - and RX circuitry had to be realigned for full coverage.

Modification of the 'Crystal Type' Walkie-Talkie

by B.W.

The 'Crystal Type' Walkie-Talkies require a set of crystals for each channel; one each; for Transmit and Receive.

The easiest modification method is to swap out the existing crystals, and order two new ones. This way will have two new Fo's (Channels); one low and one high; both out of present legal GB Band!

Example below is for using the Channel 14 crystals that usually come with Walkie-Talkies: (TX Xtal = 27.125MHz, RX Xtal = 26.670MHz.)

1. Remove both xtals from their sockets.
2. Place Transmit Xtal (27.125) in Receive Xtal's socket location 'A'.
 - a. This makes the receive frequency 27.125MHz. Since receive Fo is 455KHz below the transmit Fo, this figure must be added to obtain the new correct transmit crystal.
 - b. $27.125\text{MHz} + .455\text{MHz} = 27.580\text{MHz}$; this is the way to figure it out and is the correct frequency.
3. Place new Transmit Xtal (27.580MHz) in Transmit Xtal Socket 'A', This makes 'A', the new High Fo Channel, on the Even.
4. Place Receive Xtal (26.670) in Transmit Xtal's socket location 'B'.
 - a. This makes the transmit frequency 26.670MHz. Since transmit Fo is 455KHz above the receive Fo, this figure must be subtracted to obtain the new correct receive crystal.
 - b. $26.670\text{MHz} - .455\text{MHz} = 26.215\text{MHz}$; this is the way to figure it out and is the correct frequency.
5. Place new Receive Xtal (26.215MHz) in Receive Xtal's socket location 'B'.

*Above is for reference to Channel 14 Crystal frequencies only.

Socket locations A & B, are in reference to most Crystal type Walkie-Talkies.

NOTE: Selman Enterprises can get these new crystals that you may need. Manufacturer and Model Number of the Walkie-Talkie must be given. Also the correct frequency wanted must be given, as this will be Special Order. Use chart on next page for correct crystal frequencies.

Crystal Set; 'Swap Out' Conversion Chart for Walkie-Talkies

by B.W.

	Present Crystals per channel - set of two.		New Crystal Frequencies needed-reference to (A) and (B).	
	Tx-(A)	Rx-(B)	Tx using A as Rx Xtal	Rx using B as Tx Xtal
1	26.965	26.510	27.420	26.055
2	26.975	26.520	27.430	26.065
3	26.985	26.530	27.440	26.075
4	27.005	26.550	27.460	26.095
5	27.015	26.560	27.470	26.105
6	27.025	26.570	27.480	26.115
7	27.035	26.580	27.490	26.125
8	27.055	26.600	27.510	26.145
9	27.065	26.610	27.520	26.155
10	27.075	26.620	27.530	26.165
11	27.085	26.630	27.540	26.175
12	27.105	26.650	27.560	26.195
13	27.115	26.660	27.570	26.205
14	27.125	26.670	27.580	26.215
15	27.135	26.680	27.590	26.225
16	27.155	26.700	27.610	26.245
17	27.165	26.710	27.620	26.255
18	27.175	26.720	27.630	26.265
19	27.185	26.730	27.640	26.275
20	27.205	26.750	27.660	26.295
21	27.215	26.760	27.670	26.305
22	27.225	26.770	27.680	26.315
24	27.235	26.780	27.690	26.325
25	27.245	26.790	27.700	26.335
23	27.255	26.800	27.710	26.345
26	27.265	26.810	27.720	26.355
27	27.275	26.820	27.730	26.365
28	27.285	26.830	27.740	26.375
29	27.295	26.840	27.750	26.385
30	27.305	26.850	27.760	26.395
31	27.315	26.860	27.770	26.405
32	27.325	26.870	27.780	26.415
33	27.335	26.880	27.790	26.425
34	27.345	26.890	27.800	26.435
35	27.355	26.900	27.810	26.445
36	27.365	26.910	27.820	26.455
37	27.375	26.920	27.830	26.465
38	27.385	26.930	27.840	26.475
39	27.395	26.940	27.850	26.485
40	27.405	26.950	27.860	26.495

TRUBLE SPOT

B.W.

"GENERIC" - Jackson ? : Yep, comes with no name on front panel and microphone. It is so plain that is packed in white unmarked box, no owner's manual, frequency chart, or schematic....

Not to worry as have found the only difference to be at the DC power connector, remainder of unit is identical to units marked Jackson! 'Generic - Jackson' S/N: 43001853...

This particular unit was received by me for customer, prior to sale was to checkout and realign if necessary. Hooked up to power, switch off, - blew fuse! Pulled covers off for look see, as didn't want to return to 'Distributor' if I could fix myself.

"Spare us all" - looked like the Screwdriver Jockey went on vacation to Taiwan. In an effort to be standard to most CB 3-pin power cable as used in the U.S. - jumpered across the plug..... BUT, was done as diagramed below. Suggest that you remove covers from Generic units and check out the power plug area as a precaution.

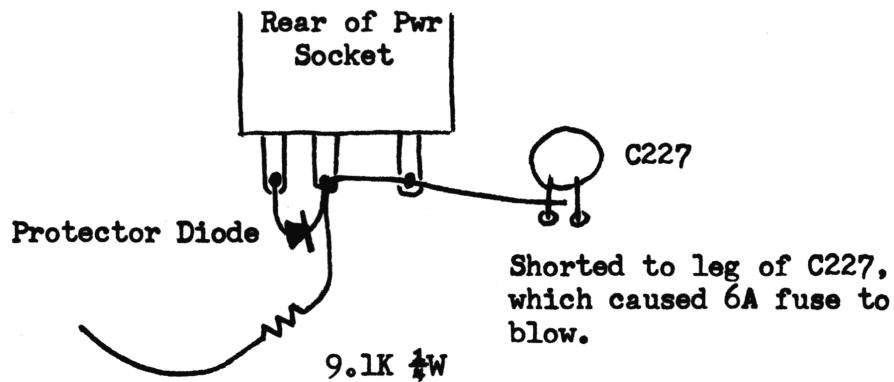

? Used this resistor as piece of jumper, but forgot to cut off the excess leads on both ends, double-check!

Out-of-Box checkout, finally - AM/FM-11W+, SSB-7W Max? Readjusted power to AM/FM-17W, and SSB to 25W (This way unit will coast for a long time and be trouble-free). Also put the extended slide in Vol. 20, page 28; into unit - worked exactly as written. The only major gripe is: not enough adjustment on VR7 even when turned fully CCW.

CORRECTION: Vol. 20, Pg. 40.

GRANT-DX (Fo Mod).

CHANGE: Pin number from 8 to 9, see partial drawing correction.

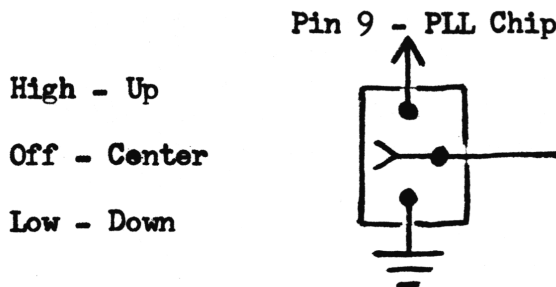

HINTS/KINKS/GOOFS

Information utilized in this column doesn't receive a free volume. But have reviewed all info and that used other places has entitled contributor to a Free-bie!

Power Supply Salvage: Try those old Teaberry Twin-T's, had dual transformers, and very good regulation.

W.A.R.C. ?? someone sent in what this meant. World Administrative Radio Conference. "The AMATEUR community won additional frequency allocations (10, 18, and 24.5MHz) during the 1979 W.A.R.C. These new bands will help to ensure good worldwide communications regardless of atmospheric conditions." T.U. - W.R.

8719 Chassis (Madison): Tx/Rx split on AM mode of operation. "lost a few hairs on this one, as screwdriver jockey almost done me in" Check L-10 alignment, found mis-adjusted.

23 Ch. 02A Chassis: Rx Audio intermittent, Tx Audio O.K.? - Found the problem to finally be C210 1,000Mfd/16V Electrolytic cap.

R.F. coming in on your telephone lines, especially those 'Touch-Tone' "EL-Cheep-0's"? Obtain some ferrite beads - open up phone - find the Green and Red leads - undo from board - wrap a few turns thru the beads!

CHEAP METERS in almost every unit leaves a lot to be desired when they peg out almost all the time; and 'jumpy'... ADD an electrolytic capacitor across the meter terminals... Start out with about 100MF/50V Axial, CAUTION--OBSERVE CORRECT POLARITY ON HOOK-UP!

CORRECTION: Vol. 4, Pg. 10,

Slider for Stalker 101/202

STEP 3... DELETE: ALL ADD: Remove R116, replace with solid buss wire.

PARTS SOURCE

DEMCO BRAND radio parts and linear parts:

Ken's Two Way Radio
2825 Lake Street
Kalamazoo, MI 49001
616/345-4609

DAK PARTS: Scanner City
15757 Crabbs Branch Way
Rockville, MD 20855
301/948-8098

LINEAR PARTS AND TRANSISTORS: RF Parts Company
1320 Grand Ave. Unit 4
San Marcos, CA 92069
619/744-0728

CROSS-REFERENCE

Lafayette SSB 120 and J.C. Penny 6247 - Try SAMS #180, Midland 79-892

J.C. Penny 6248 - Try SAMS #234, same main board as Sears 934.3831

Tram D62 - Try SAMS #179, Cobra 132XLR

Midland 13-893 SAMS 69; interchangeable with Cobra 138A SAMS 57.

Truetone CYJ4732A-77 (23-4732-6C) SAMS 121; interchangeable with Midland 13-830 SAMS 120.

Hygain 2701 (I) SAMS 165; try #120 and #121 - almost identical.

Royce 619 SAMS 254; almost identical to Royce 607 SAMS 238.

Kraco 2320B SAMS 153; almost identical to Hygain 2701 SAMS 165.

Kraco 2310; try Hygain 670B (Hy Range 1) SAMS 115.

CARD-KIT "B", UPDATE

by D.L.

Realistic TRC-414, TRC-421A, TRC-422A:

1. Remove XF (10.7 Filter), solder cable 1 into it's place. White or Yellow wire goes to the side that was connected to collector of Q3
2. Broadband T4 for maximum receive.
3. Remove D-8.
4. Separate the three wires of cable 2: solder Orange to pin 20 of PLL Chip, Brown to cathode side of D8, Red to pin 18 of PLL Chip.
5. Switch epoxy pack to low position, peak receiver: T1, T2, and T3.

Uniden PC-33, PC-55:

1. Remove FT1 (10.7 Filter), solder cable 1 into it's place.
...PC-33; White or Yellow wire is connected to collector of TR2.
...PC-55; White or Yellow wire is connected to L3.
2. Remove R-63.
3. Separate the three wires in cable 2: solder Orange to Pin 8 of PLL Chip, Brown to opposite point that R-63 was connected, Red wire to Pin 1 of the PLL Chip.
4. Switch epoxy pack to low position, peak receiver: L1, L2, and L3.

Uniden PC-77:

1. Remove FT1 (10.7 Filter), solder cable 1 into it's place. White or Yellow wire to L6.
2. Remove D20.
3. Separate the three wires in cable 2: Orange wire to pin 20 of PLL Chip, Brown to cathode location of where D20 was, Red to pin 18 of PLL Chip.
4. Switch epoxy pack to low position, peak receiver: L5, L6.

Gemtronics GTX-44, 02A-PLL
Fo Mod using Delta Tune Switch
 by J.V.

1. Remove Green, Gray, and Blue wires from Delta Tune switch.
2. Delete Gray wire at Pt. 30.
3. Re-route Green wire to where Gray wire was removed at Pt. 30, cut to length and solder to stand-off.
4. Delete Blue wire at Pt. 16.
5. Cut traces to Pin 9 and Pin 10 of PLL chip. Bridge cuts with 4.7K $\frac{1}{4}$ W resistors
6. Wire Delta Tune switch per drawing below: View from trace side of the PCB. If good, can solder to switch without removal from chassis.

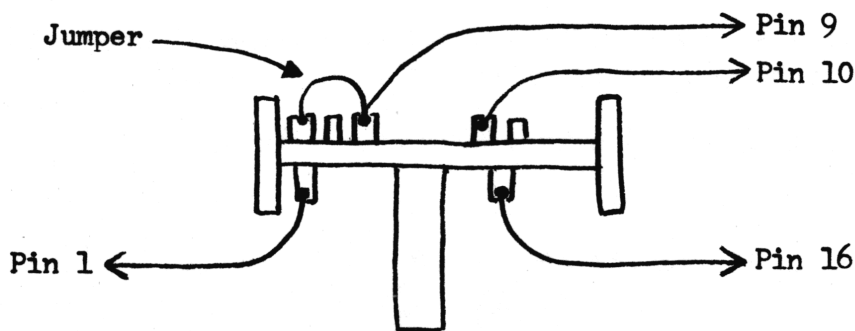

Fo's: - ; 26.755-26.955MHz, selector 10-27.
 0 ; Normal frequencies, selector 1-40.
 + ; 26.435-26.765MHz, selector 1-40.

DAK MK 9; Fo Mod: 26.695-27.010MHz (5's & 0's).
 by M.M.

Wire up two switches as diagramed below, cut etch traces to Pins 6, 10, 11, and 12 of PLL chip.

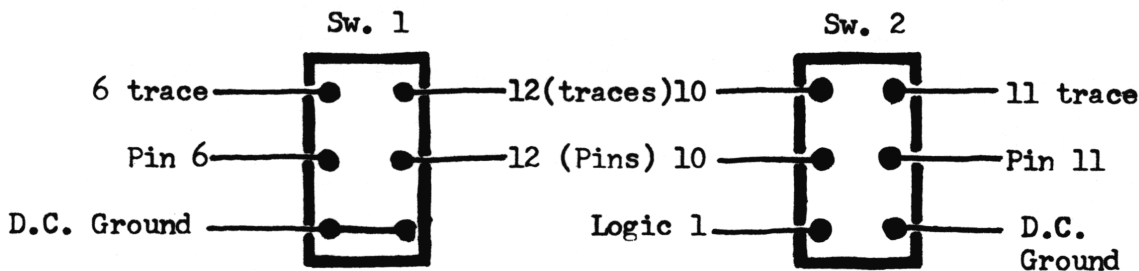

Switch 1 and 2 will give 26.695 to 26.850MHz, selector Pos. 5 - 32.

Switch 1 gives 26.830 to 27.010MHz, selector position 1 - 32.

Cobra 21XIR, 858-PLL
Fo Mod using ANL and Dimmer switches
 by J.V.

1. Remove Purple and Gray wires from ANL switch, delete both.
ANL is now permanently on.
2. Remove Blue wire from dimmer control, delete.
3. Remove Orange wire from dimmer control, re-route to where Blue wire was deleted. Cut-to-length and solder in place. If you want may insert a variable in series and adjust, just be careful to make sure it is insulated.
4. Cut traces to Pins 19, 20, and 21 of the PLL chip. Pin 20 must be completely isolated.
5. Bridge trace cut to Pin 19 with a 4.7K ohm resistor.
6. Bridge trace cut to Pin 20 with a 4.7K ohm resistor. Also solder a jumper from trace (cut side) of Pin 20 to D.C. Ground.
7. Bridge trace cut to Pin 21 with a 4.7K ohm resistor.

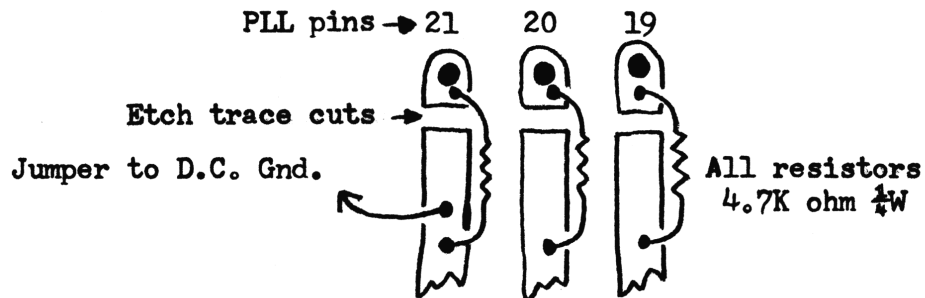

8. Wire dimmer control and ANL switch as shown below: Viewed looking down on trace side of PCB.

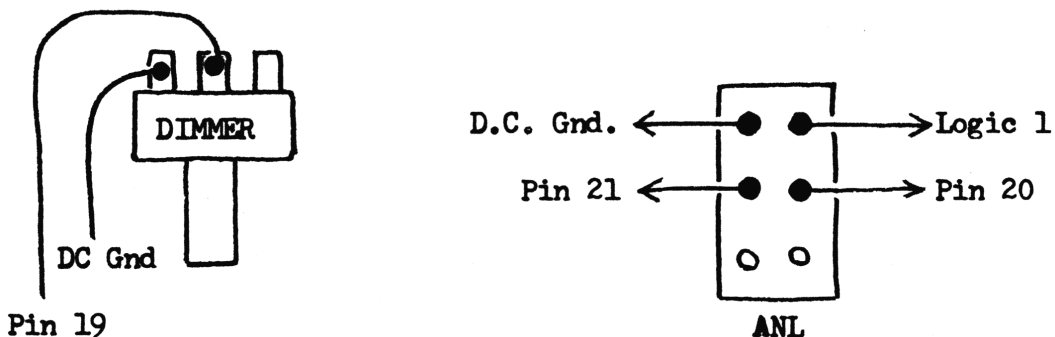

Cobra 21XLR, Fo Mod. (Cont.)

Fo Selection: ANL - On, Dimmer fully CW ... 26.675-26.805, selector 27-40.
ANL - On, Dimmer fully CCW .. 26.815-26.865, selector 5-9
ANL - Off, Dimmer fully CW .. 26.875-26.955, selector 27-35.
ANL - Off, Dimmer fully CCW . Normal C.B. Fo's...

YAESU FT-726R Fo Mod.

by K.T.

Three band: FM/SSB/CW transceiver. Low Power - 10W, with standard 2 Meter Operation. Optional modules cover: 430-440, 440-450, 50-54, and 21-30MHz. This is the 10 thru 15 Meter module.

This 21-30MHz module only covers 21-23 and 28-30MHz as sold. However it can be modified to include 24.5-26.5 for 12 Meters, and also 26-28 on 11 Meters.

Modification of the 10-15 Meter module is very simple and a Service Manual is not required. All that is required is "cutting" - REMOVAL of two diodes: D20 and D21. TX is added to 11 Meter band with D20, and 12 Meter band with D21.

Diodes are located on the PLL board: Remove the 4 small screws that hold the cover on PLL - Locate a vertical style plug and jack that is labeled J0-3, the two diodes are less than half an inch from this jack/plug towards center of board.

SSB Output Power: may be improved somewhat by adding a 2.0-2.2Mfd 25Volt capacitor to the ALC line to DC ground. Use pin 7 and 8 of any of the 11 pin connector jacks (there are 3, and all are paralleled).

Interesting and very versatile unit with Memory and Scan, Automatic Repeater/Simplex Switching, plus - on any of the bands.

FEEDBACK

Vol. 20, pg. 35; Jackson - Trouble-Spot

Disregard the cross-reference to ECG-788A, wrong... Checked the four units I have access to and found all had BA715 chip? So guess this is another cross, as schematic calls out NJM4558S. Cross out second line in Vol. 20.

FEEDBACK

Vol. 18, pg. 16; Yaesu 757GX

Received note on mike wiring of SHURE 526T: Change Black/Shield-7, to Blue/Shield-7...

* * * TALK - BACK * * *

O.K. got feedback on this.. 'To get talk back thru speaker put a 100 ohm resistor or less from ground side of speaker lead to chassis ground.'

Some one called in and said to get talk back on the Jackson-DX Clip D71.

AX/AR-144 Mod with automatic 5KHz drop
by J.A.

1. "Clean Off" Brite/Dim switch by removing R419 and R421 from switch PCB. Also remove ground line from meter lamp (tied next to R421) and reconnect to PCB ground. This 'hard wires' unit to brite mode. Clean out all holes where components removed.
2. Perform conversion from SCB Volume 11, page 17-18, DISREGARD SLIDE PART OF MODIFICATION. Wire Pin 9 through 1N914 to switch side of R421.
3. New Slide Mod: Remove clarifier White lead from main PCB and reconnect to collector of TR35. Remove Brown lead and connect to wiper of a 20K 10-turn trim pot. Connect one arm of trim pot through 1N914 to hole where meter lamp ground line was on switch PCB. (See Fig. 1) Leave other arm of pot loose, no connection.
4. On main PCB, remove D32; change D30 to a 'Super Diode' connecting a 5.6_mh choke in series to cathode side. Replace R122 with a 39K $\frac{1}{4}$ W resistor. DO NOT simply remove R122 with no replacement; as will 'overload' the Varactor and hangs up slider on one Fo per channel-NO slide at all! —This is **PROVEN MISTAKE!**— Clarifier circuitry should now look like Figure 2.
5. With unit in 'Low Fo' mode ('Dim') center up clarifier: L16-AM, L17-USB, L18-LSB. Switch to High Fo's (Brite) and adjust 10-turn trim pot until the frequency is again centered on the 'odd'.
NOTE: If you have moved the main clarifier pot, will have to start over again with this step.
6. L14 may need touching up to get all the Fo's. In some cases will require another 'Super Diode' to make the VCO stretch.

New Fo's: Dim - Regular CB channels
Brite - 27.415-27.855MHz, selector 1-40

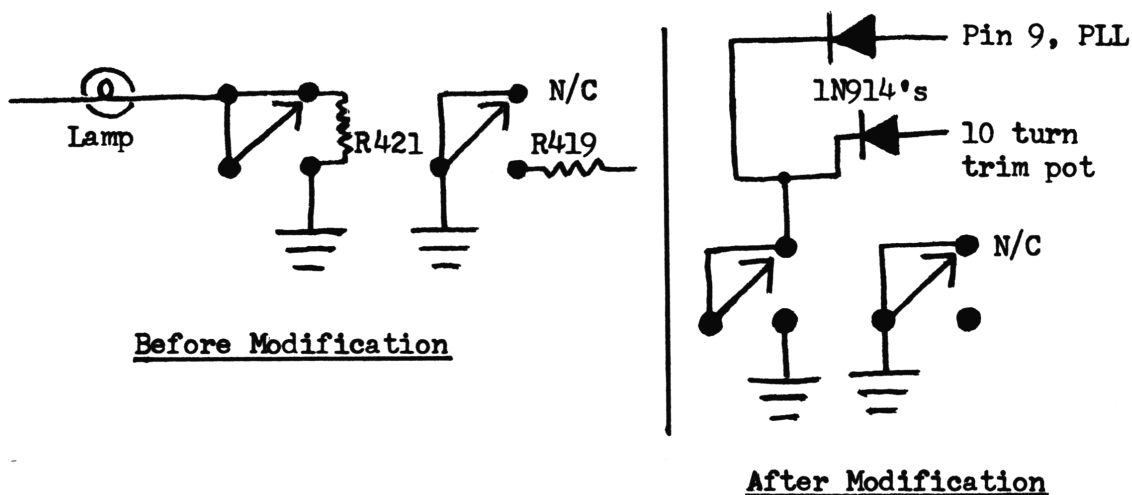
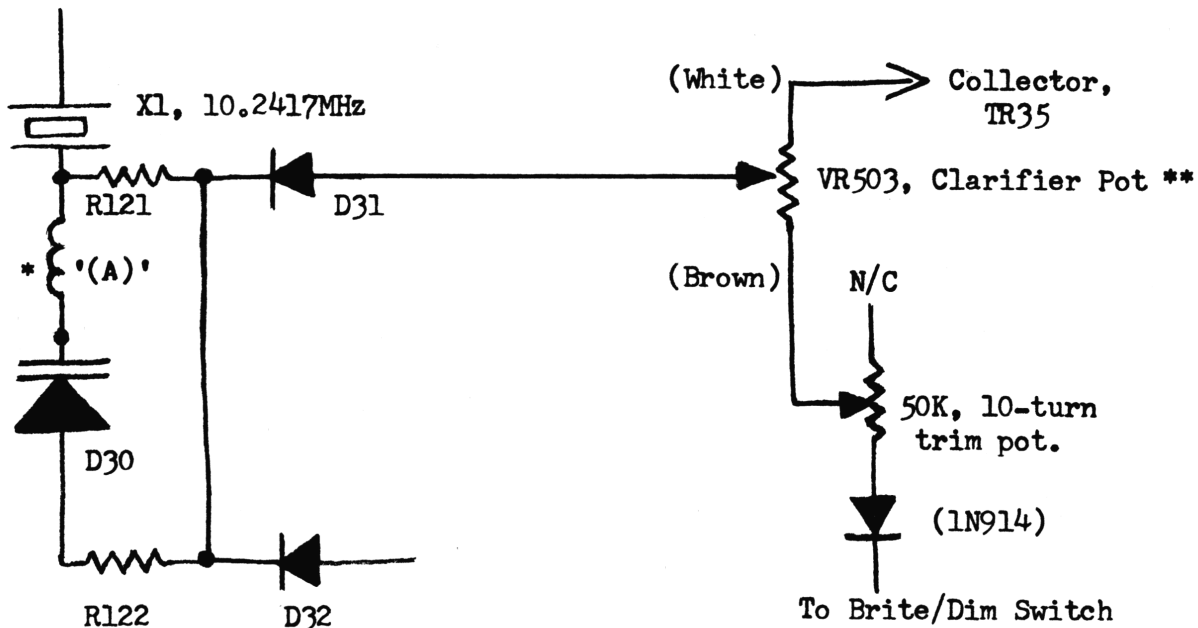

FIGURE 1 - BRITE/DIM SWITCH (BRITE POS SHOWN)

Figure 2, Clarifier Circuit...

(READ ALL NOTES PERTAINING TO CHANGES.....)



'(A)' - Choke added in series, 5.6 microhenry.

D30 - Change to a 'Super Diode'.

D32 - Remove completely from circuit.

R122 - Change to a 39K $\frac{1}{4}$ W.

* - 5.6_mH was chosen to give maximum slide without dumping. TOO MUCH downward slide on rig. R122 was changed to a 39K for same reason. In fact 'prototype' rig (S/N 130019XX) had to almost 'bottom out' slugs in L16, L17, and L18 to center clarifier.

** - Prototype used a 32K Duncan 10-turn pot. A 20K 10-turn pot would possibly work better - no 'dead spot' at ends. Original clarifier pot is a 20K.

TROUBLE SPOT

G.L.

PC66, Cobra 25GTL, and similar chassis: Final Out, replaced-still no output? Checked driver and buffer-OK. Collector voltage on RF Final doesn't pull down to proper level under TX condition. Tune L17 towards top of core (TA7310 mixer output coil). If some power returns-REPLACE L17... Will check good on VOM, but is bad.

5KC Switch for 858 SSB Chassis

by L.J.

Radio must have prior 'slide modification' to + and - 5KC (MINIMUM) of center Fo. "Also will only be exactly on frequency in the mode which was aligned - aligned in LSB, then correct reference is to LSB."

- New parts needed:
- 3 - 10K, 10 turn, PCB mount mini-pots.
 - 1 - 1K linear taper (will replace original 20K clarifier pot, so make sure has identical physical specs.)
 - 3 - 1N4148 or 1N914 diodes*
 - 1 - 3 pole rotary or ON-ON-ON toggle switch.

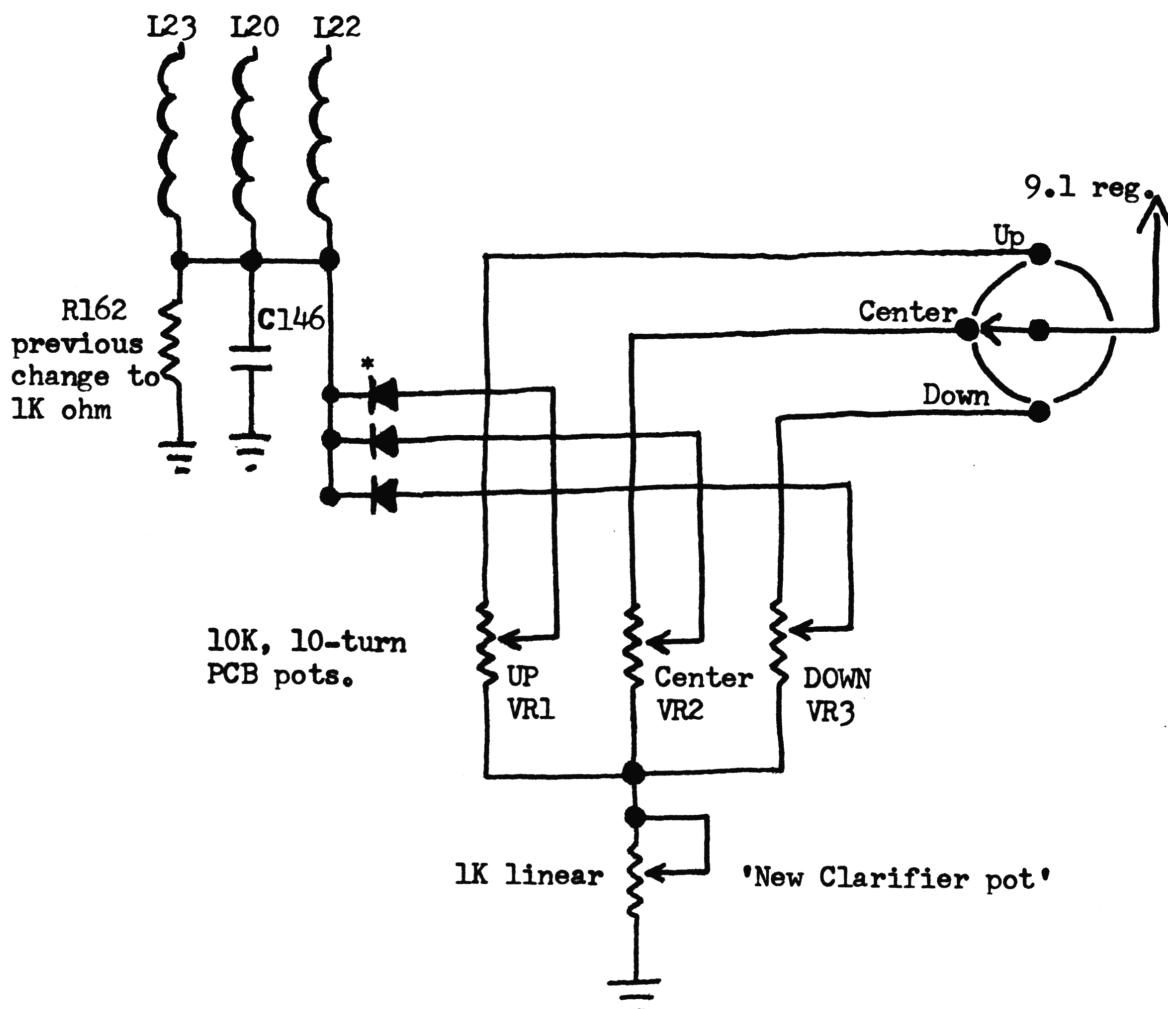

Alignment:

Set new clarifier pot to center position; mode switch to whichever mode you want to 'calibrate'.

Set 5KHz switch to UP, adjust VR1 for +5KHz of center Fo in TX mode.

Set 5KHz switch to Center, adjust VR2 for Center Fo in TX mode.

Set 5KHz switch to DOWN, adjust VR3 for -5KHz of center Fo in TX mode.

RF Gain Control for "858" Grant

by R.M.

1. Disable 'dimmer' control - wire permanently, or do the easy way.
2. Remove pot and wires, re-wire the wiring to new 20K sub-mini trimmer:

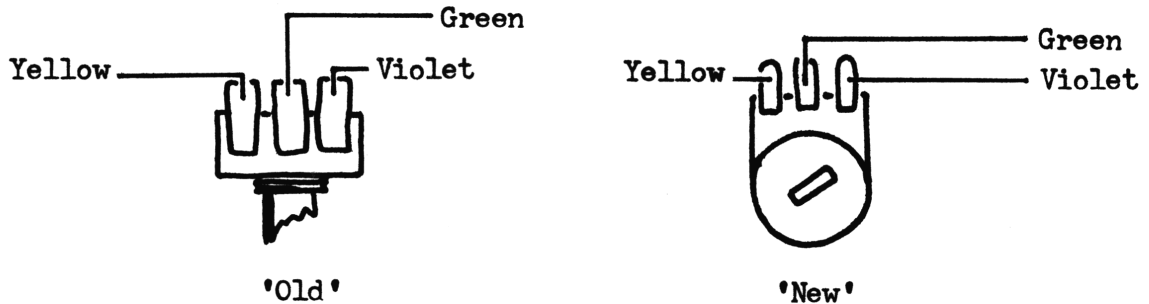

3. Adjust 'new' pot for desired light intensity, sleeve - tie into bundle.
4. Obtain 5K sub-mini pot (check shaft length for fit), and wire up as below:

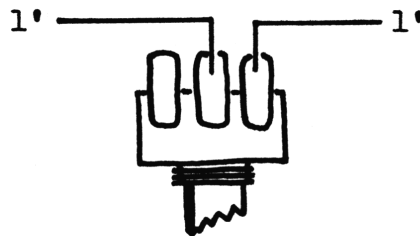

Wires-any color; length 1' minimum; install pot into chassis.
Re-route the wires toward the rear of chassis with the cable bundle.

5. Remove R-14, no replacement.
6. Remove R-12, replace with 100 ohm.
7. Solder wires from pot to each side of R-11.

NOTE: This mod was performed in a unit that had utilized the LOC/DX switch as Frequency Mod. Loc/Dx was already 'hard-wired' in DX.....

Service Information - Partial Solution

Can't find the SAMS? Try TAB BOOKS, they might still have the CB Radio Manuals in print. Circuit board layouts are better than SAMS, in most cases, and schematics are good. (Ed. Note: I have Vol 2 & 3 in my service library - GOOD.)

Factory "Screw-ups" 02A Export PCB's

by R.M.

Following 'screw-ups' are on circuit board # PCMA001S.

Some of the units involved are: Palomar 2400 & 5000; Cobra 148GTL-DA; Mongoose/Falcon/NATO/Thunder 2000; Colt/Lafayette 2400;....etc.

Schematic: 1. C73; should be marked C56 (.047 mfd).

2. RV2; should be marked 300 ohm, not 300K ohm.

3. Q17 (FET); Source and Drain reversed on schematic, correct on etch side of PCB.

Circuit Board: 1. On etch side of PCB there are 2 (two) Q32's?
The one beside Q34 is Q35, not Q32!

2. Both Q33 and Q18 are marked wrong on etch side.
Reverse B (Base) and E (Emitter).

Xtal XCB-71 40 Ch. (TC5080P - Divider!)

Layout for tuning below, as no SAMS available on this unit.

NOTE: Tuning coils I.D.'s aren't marked on PCB. All other components have ID #'s.

VR201-TX Mtr, VR202-AMC, VR101-RX Mtr, VR102-Sq Rng. If additional modulation is needed...D202 is the defeat, look close as hard to find.

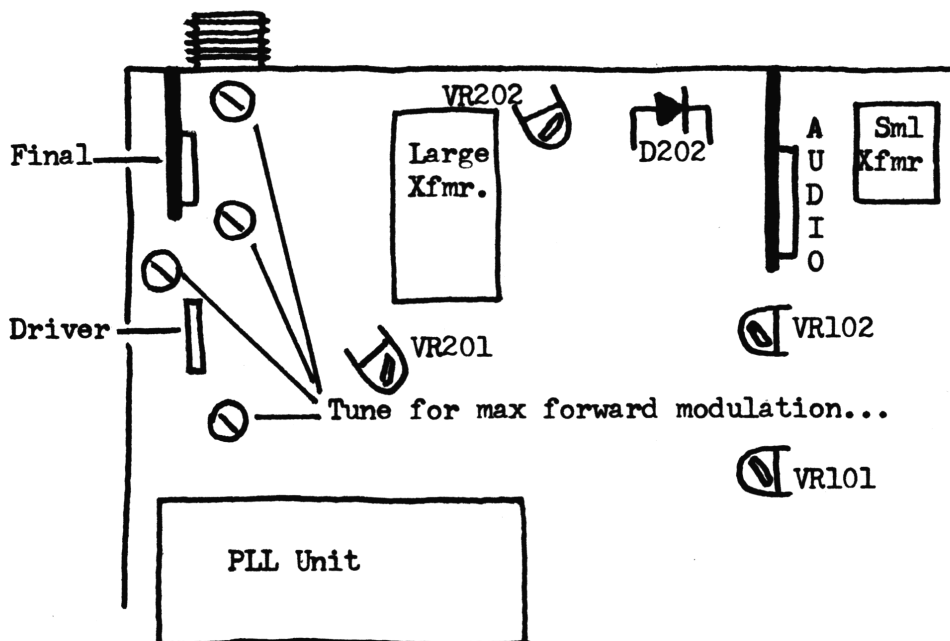

1985 - (UPDATE) SAMS CB MANUALS - Line thru #, denotes: OUT OF PRINT...

~~1~~ 2 3 ~~4~~ ~~5~~ ~~6~~ ~~7~~ ~~8~~ ~~9~~ ~~10~~ 11 12 ~~13~~ 14
~~15~~ 16 ~~17~~ 18 ~~19~~ ~~20~~ ~~21~~ 22 ~~23~~ ~~24~~ 25 ~~26~~ ~~27~~ ~~28~~
29 ~~30~~ 31 ~~32~~ ~~33~~ 34 ~~35~~ 36 37 ~~38~~ ~~39~~ 40 ~~41~~ 42
~~43~~ ~~44~~ ~~45~~ ~~46~~ 47 48 ~~49~~ ~~50~~ 51 ~~52~~ ~~53~~ 54 ~~55~~ ~~56~~
57 58 59 ~~60~~ ~~61~~ ~~62~~ ~~63~~ ~~64~~ 65 66 ~~67~~ 68 ~~69~~ 70
71 72 73 ~~74~~ 75 ~~76~~ 77 78 79 ~~80~~ ~~81~~ 82 ~~83~~ 84
~~85~~ ~~86~~ 87 ~~88~~ 89 ~~90~~ ~~91~~ ~~92~~ ~~93~~ ~~94~~ ~~95~~ ~~96~~ ~~97~~ ~~98~~
~~99~~ ~~100~~ ~~101~~ ~~102~~ 103 ~~104~~ ~~105~~ ~~106~~ ~~107~~ ~~108~~ 109 ~~110~~ 111 ~~112~~
~~113~~ ~~114~~ 115 116 ~~117~~ ~~118~~ ~~119~~ 120 ~~121~~ ~~122~~ 123 ~~124~~ ~~125~~ ~~126~~
127 ~~128~~ 129 ~~130~~ ~~131~~ 132 ~~133~~ 134 ~~135~~ ~~136~~ ~~137~~ ~~138~~ 139 140
~~141~~ ~~142~~ ~~143~~ 144 145 ~~146~~ ~~147~~ 148 ~~149~~ ~~150~~ ~~151~~ 152 ~~153~~ ~~154~~
155 ~~156~~ ~~157~~ ~~158~~ ~~159~~ 160 ~~161~~ ~~162~~ ~~163~~ ~~164~~ 165 ~~166~~ ~~167~~ ~~168~~
~~169~~ ~~170~~ ~~171~~ ~~172~~ ~~173~~ ~~174~~ ~~175~~ ~~176~~ ~~177~~ 178 179 ~~180~~ ~~181~~ 182
~~183~~ ~~184~~ ~~185~~ 186 ~~187~~ ~~188~~ ~~189~~ ~~190~~ ~~191~~ ~~192~~ ~~193~~ ~~194~~ ~~195~~ ~~196~~
~~197~~ ~~198~~ ~~199~~ 200 201 ~~202~~ ~~203~~ ~~204~~ ~~205~~ ~~206~~ ~~207~~ 208 ~~209~~ ~~210~~
~~211~~ ~~212~~ ~~213~~ ~~214~~ ~~215~~ ~~216~~ 217 ~~218~~ 219 ~~220~~ ~~221~~ ~~222~~ ~~223~~ ~~224~~
~~225~~ 226 ~~227~~ 228 ~~229~~ ~~230~~ ~~231~~ ~~232~~ ~~233~~ ~~234~~ 235 236 237 ~~238~~
239 ~~240~~ ~~241~~ ~~242~~ ~~243~~ ~~244~~ ~~245~~ 246 ~~247~~ ~~248~~ 249 ~~250~~ 251 ~~252~~
~~253~~ 254 ~~255~~ 256 257 258 259 260 261 262 263 264 265 266
~~267~~ 268 269 270 271 272 273 ~~274~~ 275 276 277 278 279 280
281 282 283 284 285 ~~286~~ 287 288 289 290 291 292 293

'85 - (UPDATE) SAMS SCANNER MANUALS - Line thru #, denotes: OUT OF PRINT...

~~1~~ ~~2~~ ~~3~~ ~~4~~ ~~5~~ 6 ~~7~~ ~~8~~ ~~9~~ ~~10~~ 11 12 ~~13~~ 14 ~~15~~

The above is new update for '85. - NOTE #'s 219 and 251 are back in print. (I guess there was a large enough demand).....

Have noticed that the price on used volumes (CB) has dropped on the 'flea market', but out-of-print Scanner manuals - no one will part with!

Uniden PC-33; CARD KIT 'B' Installation

by B.F.

Use both diagrams below for installation procedure of Fo Mod., and +5KHz jump switch.

Fo Mod - Cable Hook-ups.... INSTALL AT COMPONENT SIDE

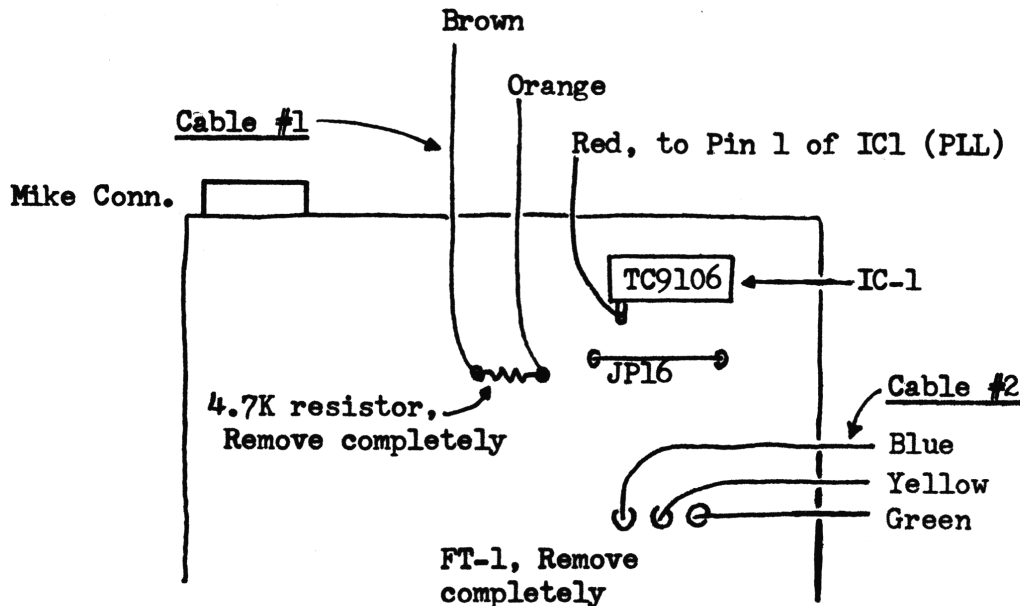

+5KHz Jump Mod - Switch hook-up, or rewire if needed as shown with different type.
ETCH SIDE SHOWN BELOW.

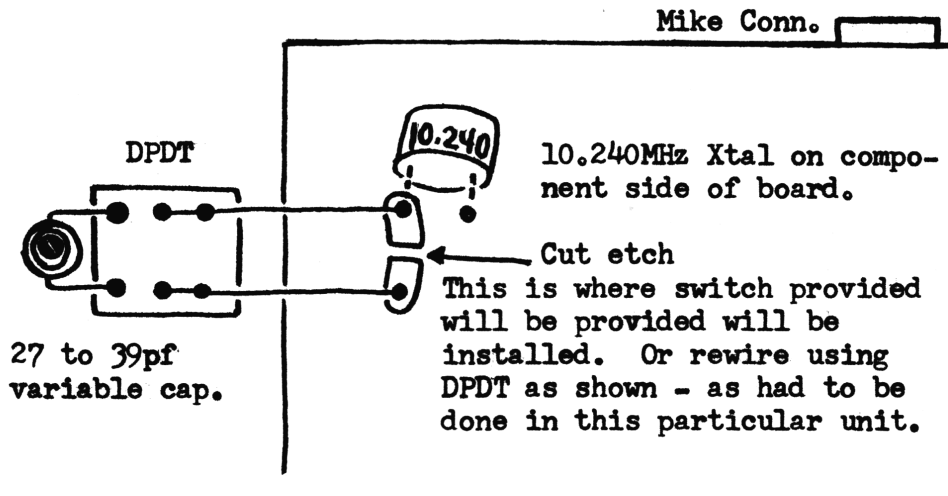

Use Vol. 19, page 40 for realignment/tune-up procedure.

Will give a nice clean operating radio.

SPECIFIC TUNEUPS

New '84 - Realistic TRC-86 (21-1608), 1W/3 Ch. Walkie-Talkie.
Cheap, low-priced walkie-talkie.....Over-priced at \$40 retail. Has no I.F. filtering! VR3-Sq Rng. RX Adj: T1, T2, T3, T4, T5, and T6. Adjust TX with antenna fully extended and use field strength meter. TX Adj; T8, T9, T10, L4, L2. (Canadian models: remove wires going to junction C72/Q13-collector, R61, and R62. Only do this if additional modulation is needed.) R45 may be changed to lower value for power increase.

* * *See page ²⁰~~48~~ for Fo Modification Notes..

New '84 - Realistic TRC-214 (21-1637), 3W/3 Ch. Walkie-Talkie.
Almost, worth the money on this one. Only difference from the other 3 Channel units is the Antenna, Ext. Ant. Jack, Ext. Power Jack, and a different RF Final. This unit does have I.F. Filtering, and is fair. VR3-Sq Rng. RX Adj: T1, T2, T3, T5, T6. Transmit may be adjusted on a dummy load or field strength meter. Suggest dummy load, and doing the final adjustment using the Antenna and field strength meter for T10 and L4. TX Adj: T8, T9, T10, L4. R41 may be changed to lower value for higher power output. If additional modulation is needed remove R60 (15K).

* * *See page 48 for Fo Modification Notes..

Realistic TRC-208 (21-1651), 5W/6 Ch. Walkie-Talkie.
Transmit: Peak in HIGH PWR, using Scope or Field Strength Meter, the antenna should be fully extended for optimum efficiency. May be peaked on dummy load: T6, L3, L6, L7, and VR5. Adjust VR3 for maximum modulation. Switch to LOW PWR: adjust VR2 for max mod. Mod. defeat is R49 (1K), located to right of audio chip on PCB component side. RX Adj: T3, T4, T1, T2, in this order. VR1-Sq Rng. NOTE: R/S part # for new antenna is A-0292 and some \$\$\$....

* * *See page 48 for Fo Modification Notes..

J.C. Penney 981-6221 (uPD861-PLL, 2-Xtal Chassis).
CAUTION: Square holes in some tuning coils...Use correct tuning tool. Transmit: Peak - T701, T702, T703, T704, T705; R708 may be changed to a lower value to increase power. Receive: Peak - T101, T102, T201, T202; DON'T TOUCH T104, unless you are familiar with NB adjustment! Change C211 to 3.3Mfd/50VDC electrolytic to improve noise - be careful as will deter audio; might have to start with a lower value. RTL-S Mtr; RT2-RF Mtr; RT101-RF Mixer Gain; RT102-TX Fo Adjustment. Modulation increase may be achieved by removing D502 and/or Q502 also. Overall performance of unit - fair.

CORRECTION: Vol. 19, Pg. 34.

GRANT-DX, UPPER Fo MOD.

CHANGE: Pin number from 8 to 9, see correct drawing below.



SERVICE NOTES:

Jackson - 2SA473 failure, TR501. Original part specs 10W/3A. Change to an ECG-153, 50W/7A.

Teaberry, President, and Sanyo CB parts: Note-the old President parts have been sold off to following company. Also have the inventory of old Teaberry parts; and the SANYO built units. Any unit with the following PLL Chips is a SANYO unit: LC7110, LC7113, LC7120, LC7130, LC7131, LC7135, LC7136, LC7137.

B.C. Electronics
4403 W. Franklin Road
Indianapolis, Indiana 46226
(317-549-2035)
Attn: John Brown

DON'T ASK WHY?

....148GTL-DX (Late)....

Customer didn't like clarifier set-up as it came, couldn't understand dual controls.

"Wanted a different type like regular C.B. that had been changed over, and one control knob".

So; modified to his wishes with +5KHz of swing; and kept old pot/knobs as part of the deal.

1. Remove the Yellow wire from original dual pot, (front pot, middle).
2. Remove all existing wires remaining on original pots at PCB, put old pot/knobs/knob retainers in the 'goodie box'.
3. Obtain 20K linear taper pot, and rewire as below - then realign.

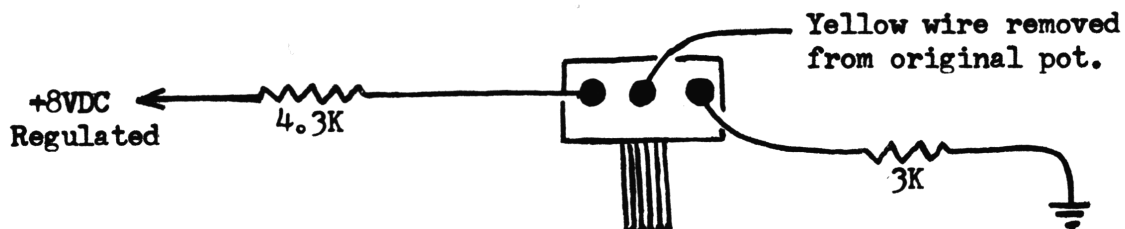

"Seems like I get all the odd-balls and old units into my shop for repair, and this was no exception. No Sams or schematic! Almost turned it down for repair, but it turned out a lot better than I thought."

Unit has a 2SC1816 RF Final, (16W, 4A); mica insulator - but no heat sink compound?

Tuneup: VR202 - AMC, VR203 - TX Mtr, VR101 - Sq. Rng., VR102 - RX Mtr,
Tune L203, L204, L205, TC202, T203, T205, and T206; for max forward.

Fo Conversion: 26.055 - 27.405MHz.....

1. Remove Gray wire from channel selector; wire to SPST as shown below; also run another wire from switch back to where original wire was removed.

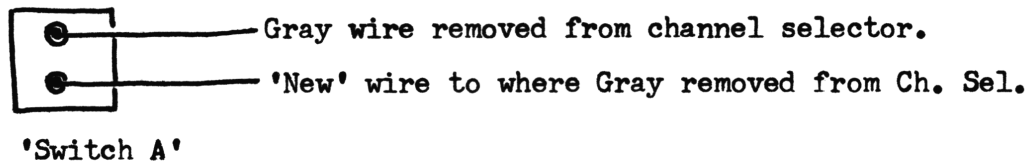

2. Remove Purple wire from channel selector; wire to SPST as shown below; also run another wire from switch back to where original wire was removed.

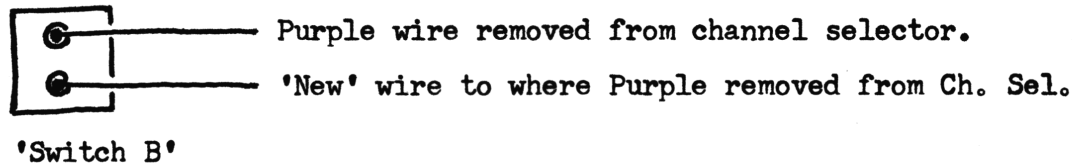

Fo's.... A and B OPEN: 26.055-26.315MHz, selector pos. 5 - 27
A OPEN: 26.325-26.685MHz, selector pos. 1 - 32
B OPEN: 26.695-26.955MHz, selector pos. 5 - 27

VCO will have to be re-tuned for full Fo Range. Remove top from PLL cage. There are no Parts I.D. #'s in PLL circuit. See drawing below:

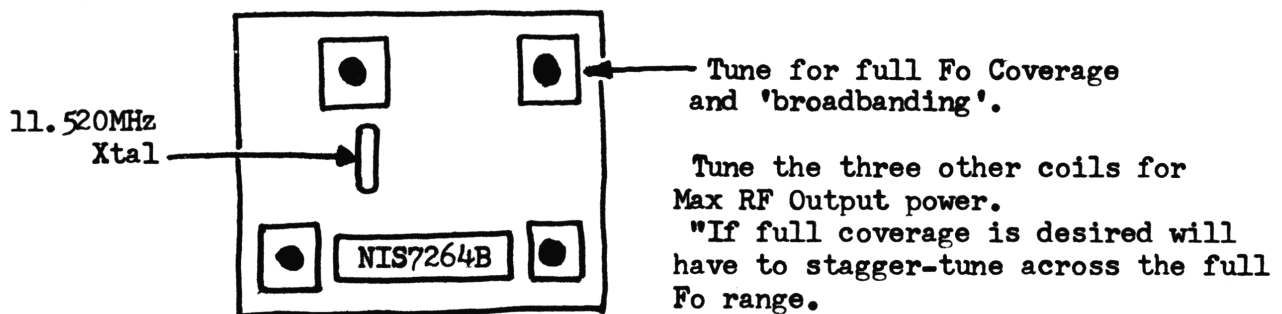

Final results on initial unit: 4W-26.055; 5W-26.315; 6W-26.685;
6.5W-26.955; 6W-27.205; 5W-27.405.....

Channel rejection was fair-good; if more needed; see prior SCB #19.
Forward swing was good on all Frequencies after modification.

Preventative Maintenance/Repairing those Top-Loaded Whips
by B.W.

Most of the so-called 'Economy Whips' have one common fault. They are epoxied into the base and come loose after being flexed back and forth. I have seen antennas go bad in a week, and people throw them away.

The 'braid' busts after epoxy loosens up and the antenna comes apart. Solution is easy and doesn't cost anything in most situations. Drawing below is for example only -

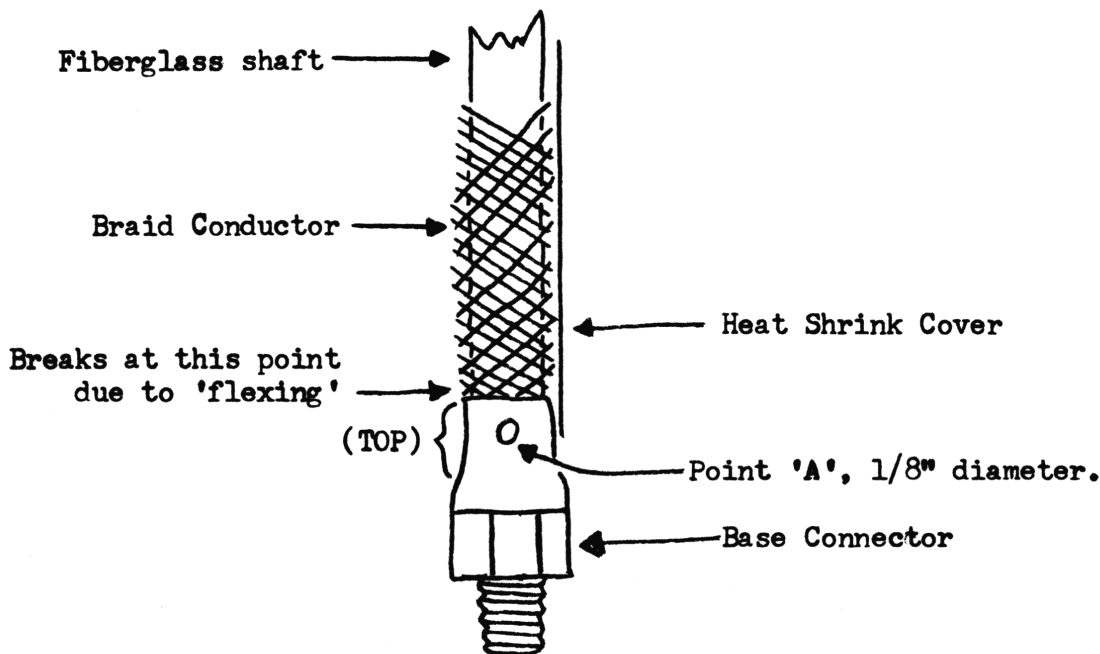

To prevent this flexing movement, drill 1/8" hole in top section and install a roll pin. Will have to file flush with connector, and seal with a rubber sealant compound. THIS IS PROVEN, as do this to every case of antennas I get in.

If whip has come apart, no problem - as long as you have both parts. Follow directions below to the letter and fix it in less than 5 minutes.

1. Strip away about 3" of shrink cover from where rod came out of the base.
2. Obtain 6" of 1/2" diameter heat shrink, slide all the way up rod toward load and tape it temporarily out of the way.
3. Use file and rough up base connector (top section) so solder will adhere readily. Don't forget to clean out the inside also.
4. Obtain 3-4" of outer braid from piece of RG/8 (easiest to find). Don't pull tight, as must be opened up even further to fit over top portion of base connector. When opened up large enough to fit-slide up shaft and secure with tape.
5. Slide rod into base connector, bottom out - drill hole, and insert the roll pin. Don't forget to file flush with base.

P.M./Repair of Ant. (Cont.)....

6. Slide 'new' braid down shaft per drawing and 'solder' in place after stretching tight — a small propane torch may be used to solder with CAREFULLY! See illustration below:

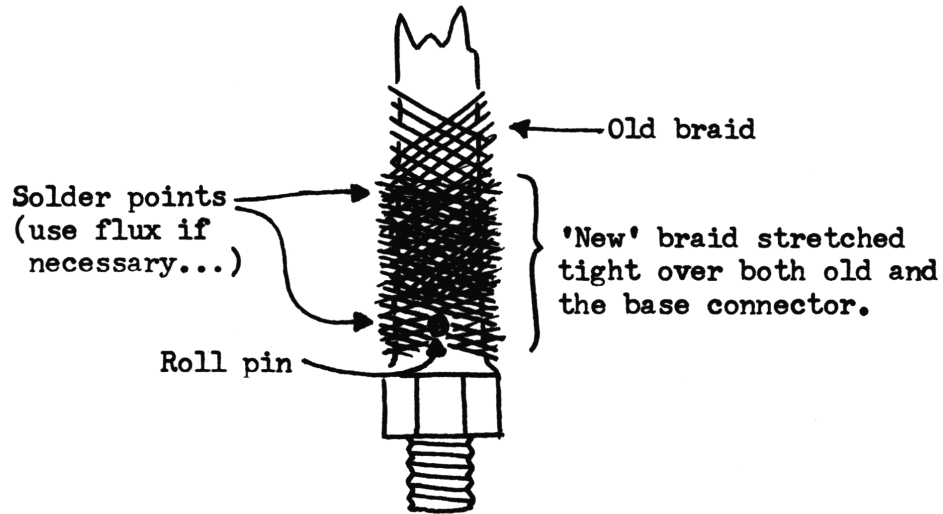

7. Let COOL, - carefully separate a few strands of new braid at junction of base connector and rod. Run a few drops of "Super Glue" in the crack. CAUTION-WATCH OUT YOU DON'T GET ANY ON FINGERS. Look funny walking around with an antenna glued to your thumb!
8. Slide down the heat shrink and cover/shrink the entire repaired area. NOTE: If you haven't cleaned up all the rough edges will split the shrink!

Repairing these sounds like a lot of work, but really isn't! I usually wait until I get 5 or 6 antennas together and do them all in $\frac{1}{2}$ hr. 'Repaired' this way are perfect for motorcycles, as they will mess up one of these in short order-if not 'modified'.

TROUBLE - SPOT
AZDEN PCS2000 (2 Meter Rig)
by M.M.

Trouble: TX Fo off by 100, 200, 300, 400KHz at different frequencies..?
Solution: The 4015 CMOS Shift Register chip in Control Head.....

ICOM 720A; Tx from 1.7 - 30.0MHz
by G.S.

1. Remove top from radio.
2. The board on the middle left side... There is seven modular plug-in's going around board.
3. Second from left plug-in, next to R126 is Blue Wire.- Cut! Radio will now transmit across range.

T R O U B L E - S H O O T I N G

TRC-458 (858 SSB Chassis): No AM TX, on SSB TX the relay sounded like a machine gun. After checking everything I could think of, gave it the old 'Smoke Test'.. (Hooked up to a 20A Power Supply; and keyed down in SSB). Results: FAST - No Smoke; but a H___ of a BANG; pieces of C179 all over the place! AM and SSB Tx came back with no problem..... "C179 is a small Blue Tantalum Electrolytic capacitor; 2.2Mfd/25VDC; in this case was breaking down when voltage put to it." SUGGEST: Replacing in all chassis with 2.2Mfd/50VDC electrolytic - don't use another tantalum! Remember these units are getting a few years on them now....

Pres. Adams (858 SSB Chassis): No TX in both AM/SSB.....

Traced signal back to FET 7, had prior to that point. So changed part - had no effect? Re-checked all voltages in RX/TX, still no problem found. Changed FET 6 to see if was opening up under load, and it was! Weird problem.

Pres. Adams..ERRORS

SAMS CB 176; error on page 107 (President Adams): Schematic shows two C-102's; only one is in the circuit/PCB. Located to right of VR8. This capacitor does give problems; advise changing to 330Mfd/25VDC minimum - electrolytic.

Adams PCB marking error (Ref: S/N:03000163): two (2) TR29's are marked on the PCB, error is on board marking. Correct locations and markings are below. SAMS CB 176 is correct as to location of correct parts.

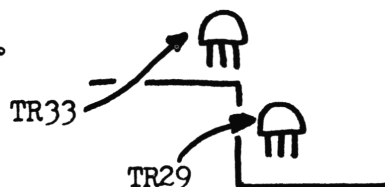

Jackson: Audio "Distortion/Blaring"
by R.M.

At close range the Jackson has the problem of receive SSB audio being distorted, the RF Gain has very little control over this.

By removing/changing the following parts can be cured:

1. Remove C-31 (0.47Mfd/50VDC electrolytic), no replacement.
2. R-43 (10K); change to 1.5K.
3. R-41 (150K); change to 270K.
4. R-47 (1.5K); change to 3.9K.

See partial schematic below of components to be changed: (*)

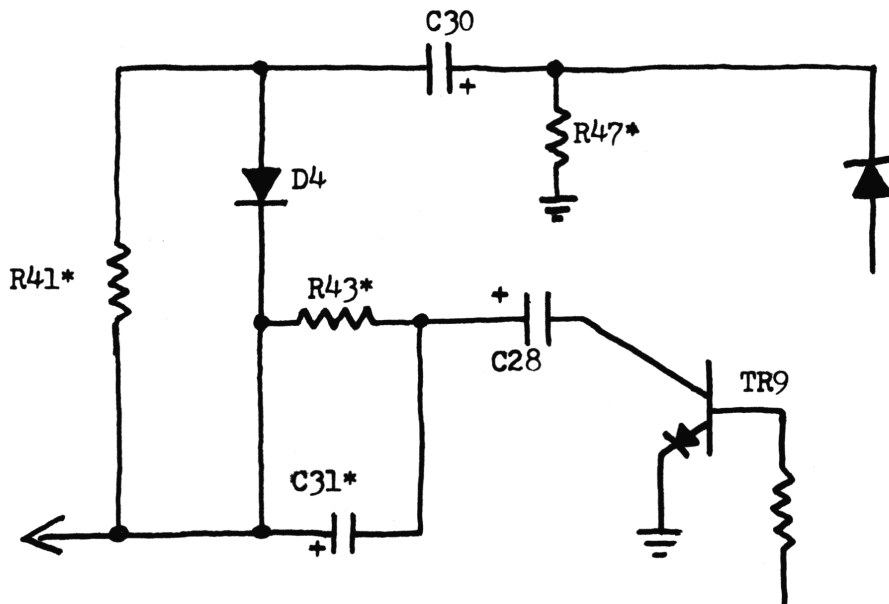

Pacific 800 SSB - Feedback

"C-Team" had this in their files: IC1 - SL1611C can be obtained from Dynascan (Cobra). Reference is IC512, P/N: 307-152-9-011 (Fo Cntr. Circuit.); of the 2000GTL.

IC2 - SL1612C can be obtained from Pathcom (PACE), while supplies last. Reference is IC2, P/N: IP20-0427; Pace Mdl. 8093.

Grant-DX, Clarifier Mod.
by B.W.

Had unit sent to me for clearing up the clarifier modification that everyone is still having problems with. THIS WILL BE THE LAST CLARIFIER MODIFICATION PUBLISHED ON THE GRANT-DX!

Out-of-the-box (S/N: 43006320). RF Driver and Final - both have thick insulators - change to thin mica insulators at your 1st opportunity.

CAUTION: Unsolder transistors before changing the insulators.

AM/FM - 5W, 50%+ modulation on AM.
SSB - 8.5W, at max mike gain

Turned up AM/FM to 8.5W - Deadkey, Modulation to 85% + . SSB was turned up to about 17W, at max mike gain.

Clarifier Mod:

1. See drawing below, remove the clarifier pot wires from the small push button PCB. Observe the colors!

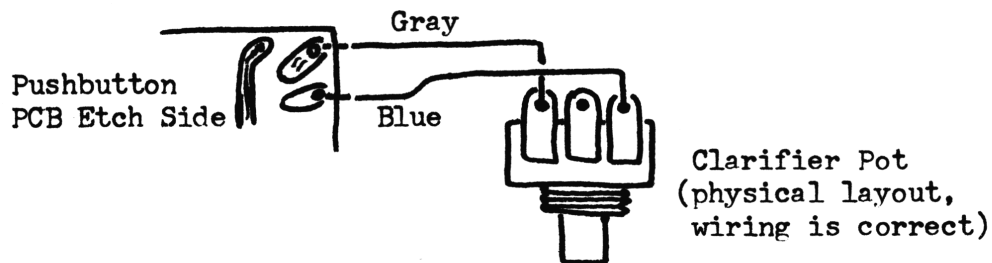

2. Route wires to etch side of main PCB, and solder carefully where indicated. **CAUTION:** Check with VOM to make sure that you have the correct places! A - D.C. Ground, B - 8.5 VDC (non-switching). Location is left front of the PCB.

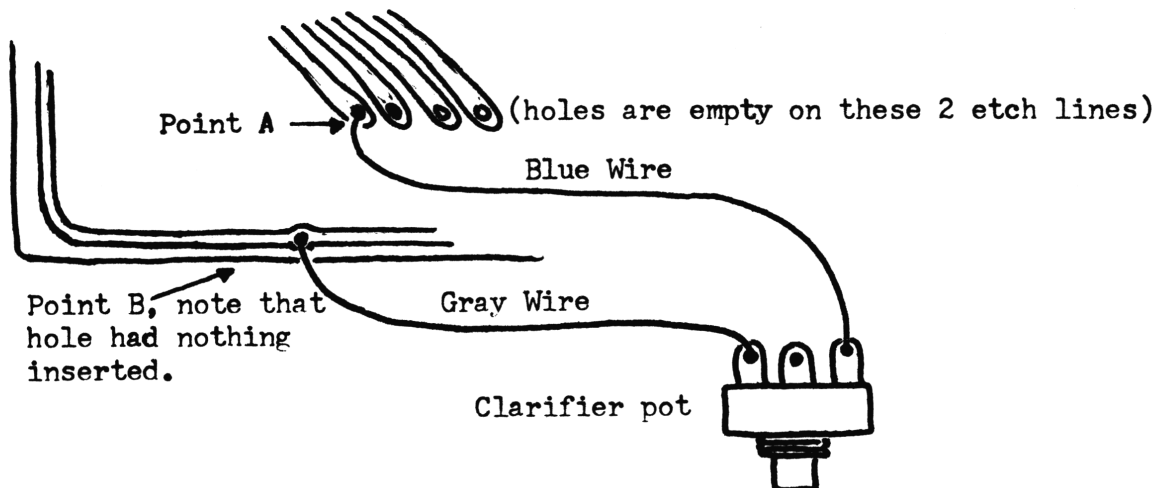

Grant-DX, Clarifier Mod. (Cont.)

3. Remove D45, no replacement.

Remove D79, replace with solid buss wire.

Check out 'slide' with present varactor diodes. Test unit - reference:
27.205MHz no adjustment to circuitry. -2.2, +2.6KHz.

4. For additional range of 'slide', perform the following exactly as written!

Remove D44 and D40; clean out the holes where components removed on PCB.

Use drawing below, install the jumper and 'Super Diode'.

Test unit - reference: 27.205MHz no adjustment to circuitry, -4.1,
+5.8KHz.

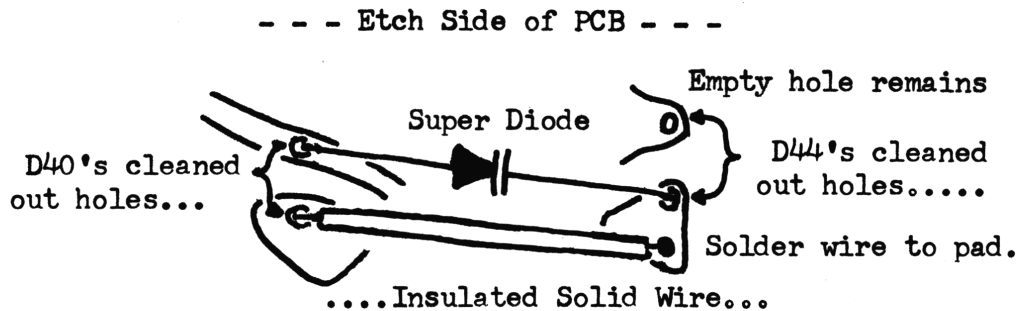

5. Leave channel selector at 20 for remainder of line-up. All frequency readings taken from dummy load in TX condition.

A. Mid Band - AM, clarifier knob centered. Adjust L25 for 27.205MHz, check shift for even plus/minus balance. L28 may be adjusted for balance if needed. Check High Band for 27.655MHz at knob center.

B. Low Band - AM, knob centered. Adjust L22 for 26.755MHz, check shift for even balance. Don't adjust L28 again or will have to realign Steps A and B.

C. Mid Band - USB, knob centered. Adjust L26 for 27.2065MHz, check shift for a minimum of plus another 5KHz upward. If needed adjust L29. Double-check that can shift below center frequency by at least 2KHz. High Band should read 27.6565MHz at knob center.

D. Low Band - USB, knob centered. Adjust L23 for 26.7565MHz, check shift for a plus 5KHz additional. Also a minus 2KHz below the center frequency. IF NEEDED; L29 may be re-adjusted; but will then have to realign steps C and D.

Grant-DX, Clarifier Mod. (Cont.)

- E. Mid Band - LSB, knob centered. Adjust L27 for 27.2035MHz, check down shift for a minimum of 5KHz. Up shift should be at least 2KHz above center frequency. IF BALANCE ADJUST NEEDED: Adjust L30 while checking for dropout on the low end. Check High Band for 27.6535MHz at knob center.
- F. Low Band - LSB, knob centered. Adjust L24 for 26.7535MHz, check for down shift of 5KHz minimum. Up shift of 2KHz above center frequency. DON'T ADJUST L30 UNLESS ABSOLUTELY NECESSARY!
6. O.K., now for 'alignment' in #5. I usually set all "Export" rigs for: -1.5KHz in LSB; center Fo in AM/FM; and +1.5KHz in USB.
- Reference to the 'Clarifier' knob at dead-center, "12 O'clock".
- (U.S. units are usually set for \pm 1KHz offset in the sidebands).
7. The only other thing I changed was C76 (1MFD/50V Electrolytic), and replaced with 3.3MFD/50VDC electrolytic. NOTE: + goes to D.C. Ground!
8. The 455KHz filter could stand 'doubling/tripling' up in series, as the rejection isn't that good!
-
-

DE-BEEP

Superstar 3600FM:

Find jumper 'J-9', remove/replace with a switch. Or just hardwire the Ch. 9 sw. and use it.

Colt 160DX (Excalibur) - Export Mdl. 02A Chassis.

Locate Purple wire from microphone jack to beep board, remove at board. Solder a new wire to point '4'. Solder a new wire to point 'P', Remove the two wires on N.B. switch and hardwire permanently ON.

Use diagram below and solder wires to N.B. switch:

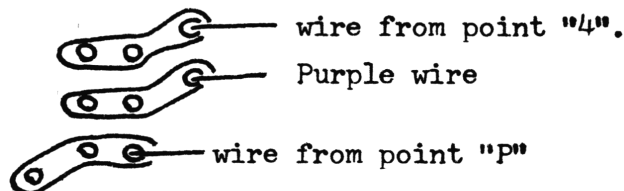

Wired up as above will give: Beep when NB is ON, none when OFF.

UPDATE: HORIZON 29A, Schematic Change

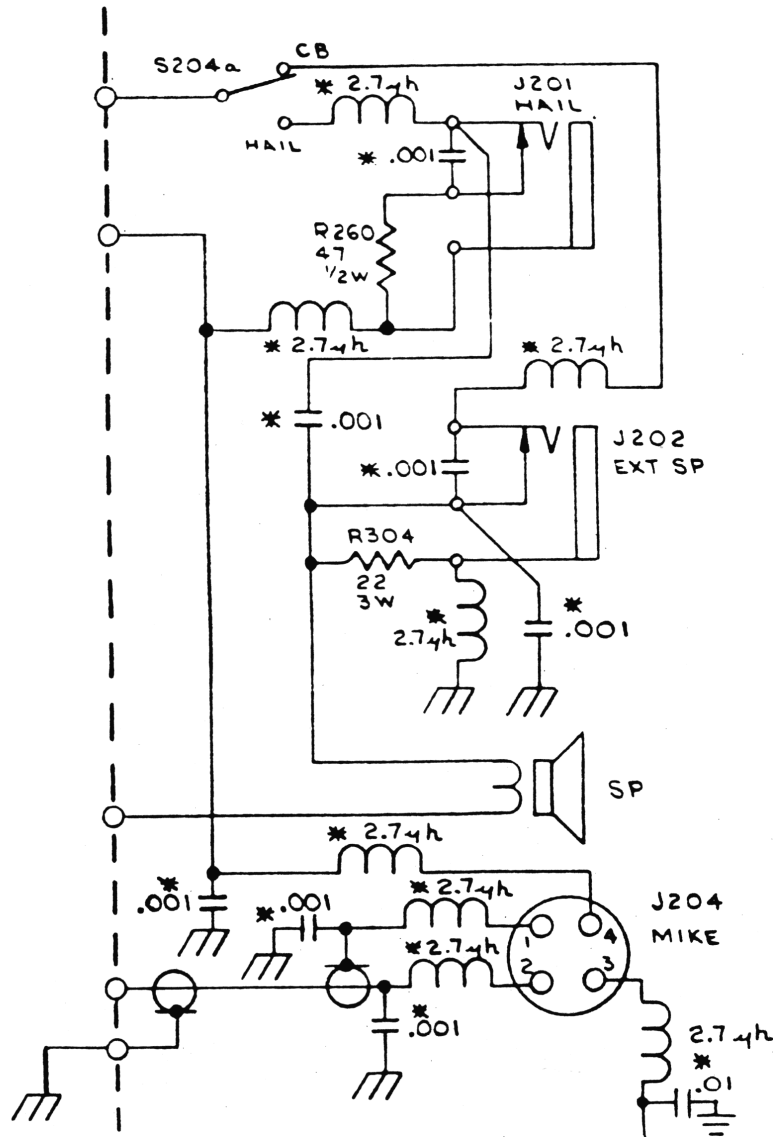

Above diagram shows revision to mike and speaker circuit for the Horizon 29A. Check against your original schematic or SAMS. Parts added are indicated with an asterisk (*).

SALVAGE THOSE BATTERY-OPERATED IRONS

Replacement batteries for the battery-operated irons are hard to come by; and if you do find are \$\$\$\$. Use the schematic diagram and theory in SCB 17 pgs. 49-50. (As a guide - as the circuit doesn't provide enough current!) Ideal specifications are 2.5VDC at 2.5Amps; this way will save on tips also. Just remove old batteries and hook up the new power source to connections.

DNT HF-12/3 (FM Walkie-Talkie)
by B.W.

Received a pair of these in the mail for checkout. NOT the units that have been looking for - but! These little units have a definite use for 'Short Range Communications'

3 FM Channels, Call Tone, and Squelch Control; all take this out of the TOY realm. Excellent little unit for it's intended purpose. Owners Manual has schematic/parts layout/parts list.

Note: Errors on parts list... Tx Ch 7 - 13.8306MHz
Tx Ch 14 - 13.8653MHz
Tx Ch 19 - 13.8905MHz
Rx Ch 7 - 27.20625MHz
Rx Ch 14 - 27.27625MHz
Rx Ch 19 - 27.32625MHz

Serial # on these units: V-1 20 (13781) and (11889). Case cover states that unit is 2W. But upon checkout found them to be putting out a maximum of .3W on dummy load.

Use diagram below for TX alignment; with antenna fully extended; peak for max signal on RF Strength Meter.

Component Side of PCB

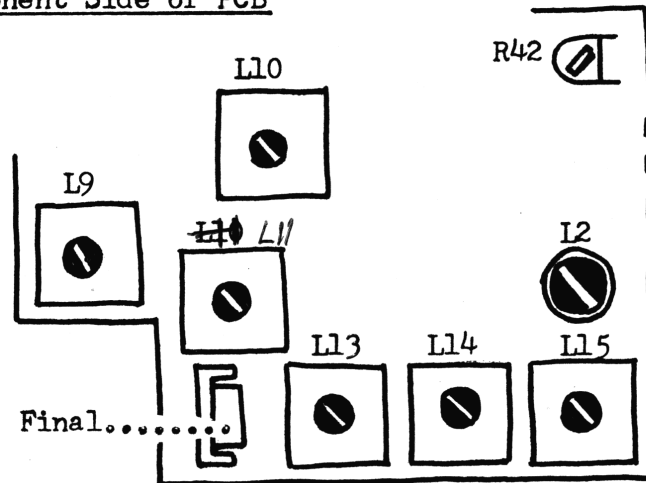

R42 - FM Insertion adjustment, have found that almost fully CCW is about best position. Adjust for best RX using another unit.
L10, L11, L13, L14, L15, and L2 - adjust for max RF.
L9 - Carefully adjust for max signal, if adjusted wrong the Call Tone and RF will drop out.

For the price is hard to beat, perfect for Camping/Hunting/etc.

ARGO-300 SCHEMATIC

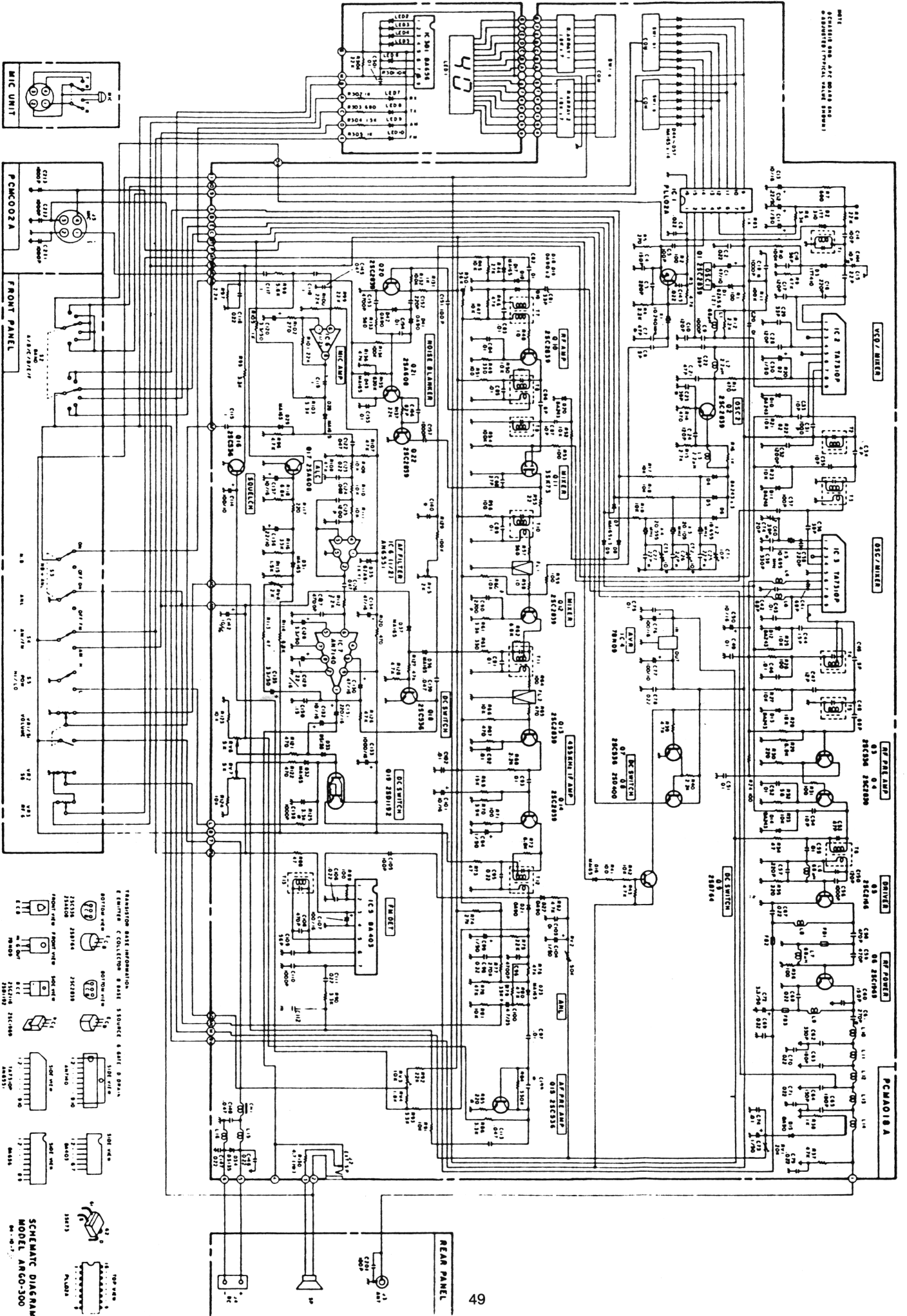

ARGO 300 (Export)

"No Name" on box, manual, microphone, or unit. Some come with a schematic and frequency list.

A "NEW" 02A PCB for AM/FM; PCB# PCMA018A. Everything is on the one board now. It isn't completely stuffed, and some markings indicate that it has 'Roger Beep' circuitry etch on it - BUT not in this unit.

Out-of-the-Box:

<u>Frequency</u>	<u>Power: Low-High</u>	<u>Modulation was 50%+</u>
26.065MHz.....	3.0 - 5.0	
26.515	3.4 - 5.6	
26.965	3.8 - 6.0	
27.415	3.8 - 6.1	
27.865	4.1 - 6.7	
28.315	4.0 - 6.6	
28.755	3.8 - 6.3	

Overall - out of box wasn't bad! Unit does need tune-up and some circuitry changes.....

ADJUSTMENTS: RV1 - TX Lights adjustment (suggest changing to 100K, as the present 20K doesn't give enough adjustment when in high power mode).
RV2 - RX Lights adjustment.
RV3 - Squelch Range
RV4 - AMC, defeat if needed is C135 (3.3Mfd/50VDC electrolytic).
RV5 - FM Deviation adjustment. NOTE: I realize that not everyone has FM equipment for test/alignment. Adjust for best reception on another unit in TX mode.
RV6 - RF Output, AM. Don't exceed 10W DEADKEY!
RV7 - RF Output, FM. Don't exceed 12W DEADKEY!

NOTES: RF Power.... The Low power is determined by the amount of R125, which is 3.3K. By varying this resistance can change the proportion of low to high power. Example: In test unit 3.3K was replaced with a 1.2K; this gave almost half of whatever the High Power was in the Low Power position. Remember that AM and FM power levels can be individually set in this unit. Also this unit uses the 2SC1969....

Heat Sinking.... Is as usual, done with the thin plastic wafers? Q19, the DC switch was not a 2SD1192 as schematic indicated, 2SD837. C138, 1000pf was not in circuit. Unit also had a 2A AGC fuse, will probably blow if you turn power up to 10W - replace with a 3A AGC (Don't exceed 4A!).

TUNE-UP: RX - T7, T8, T9, T10, T11, and T12. Carefully.....
adjust for overall frequency range clarity/strength.
TX - T2, T3, T4, T5, T6, and L10 (Schematic doesn't show as a variable but is!) Adjust for linear power across entire frequency range.

ARGO 300 (Export)... Cont....

NOISE LIMITER: Noise Limiter is good in this unit but can be improved some. R81 (10K) can be changed to a 1K for normal operation and be useful without the Noise Blanker being turned on. The value of C100 may be changed to a higher value; but be careful as audio will fall off; if a much greater is used. Tantalum capacitor is O.K.; instead of electrolytic; also the positive lead goes toward ground side (switch side-R81).

REJECTION: ??, this unit definitely needs some work done in this area. Use SCB Vol-19, Pg. 61 as a how-to guide. Remove FL-2 and replace per diagram below:

VIEWED AT THE PCB

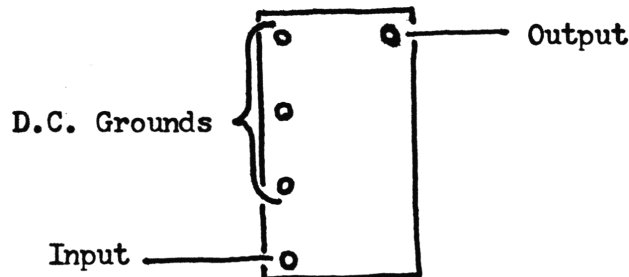

Realistic TRC-414, 421A, 422A

Receive Broadband Modification

Use diagram below for Rx modification of T-4. Is needed if installing Card-Kit B into these units.

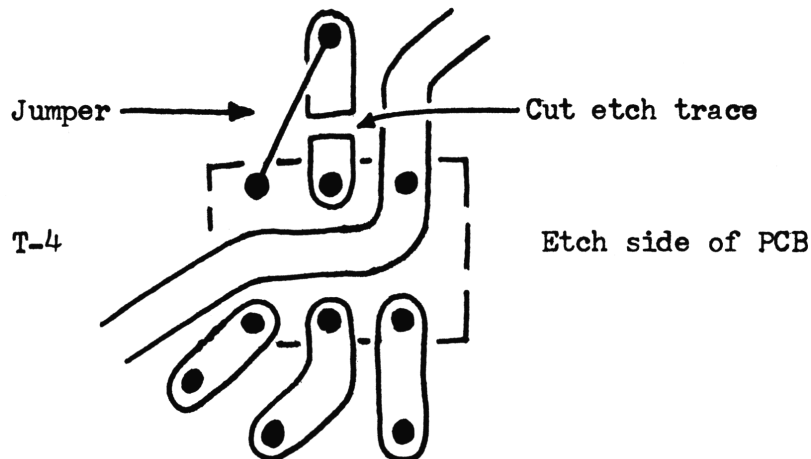

Stalker "ELITE" (Re-manufactured Stalker 9FM)

by B.W.

O.K., I got ahold of one of these units to see what it really is! (Swapped a TRC-457 even up!)...

Here are the specs: Xtal and Logic switching; 25.915-28.015MHz; "No misses". Plus and minus 10KHz switch; slide and 'HOT' receive/noise circuitry. Power minimum across band: 5.8W-AM/FM, 10W-SSB. S/N on this particular unit 13006123.

Xtal/Logic switching: 2 external switches are used; one on bottom (2 pos.); other on side (3 pos.). These 2 switches in conjunction with High/Low Band and Channel Selector, do the Fo selection. (PA/CB switch is also modified as plus or minus 10KHz switch: -10KHz on Hi Xtal, and +10KHz on Lo Xtal.)

Receive and noise circuitry are modified and very sensitive! No dropping off on the receive quality on ends of Fo band.

Slide: On Lo Xtal -5.5 to +1.6KHz; Hi Xtal -3.5 to 4.6KHz.

Power across the whole band was: AM/FM-25.915 (5.8W), 28.015MHz (6.7W). SSB-25.915 (10W), 28.015MHz (15W).

Overall - Good unit, but really have to study the Fo Chart if you don't own a Fo Counter.

(NOTE: I am not certain, but think the modification write-up will be available through Selman Enterprises. Will not be published in SCB, catalogue item only.)

Major M-120 'ALPHA'; Marko CB-444 'ALPHA' (Re-manufactured Units)

by B.W.

These units are basically the same; however the "Custom Conversion" write-ups are different; to make up for the circuitry differences. These are new catalogue items for Selman Enterprises.

Present Fo range of units is 26.965-28.305MHz, AM/FM. The conversions go into rejection, VCO, receive, and Fo expansion. No new switches are used, only existing. Complete line-up and Fo Chart is included. The new Fo range on units is: 25.685-28.305MHz for a total of 234 channels. (NOTE: A 'Super Diode' is required in conversion of these units to ALPHA.)

TROUBLE SPOT

MIDLAND 77-104's: Had a bunch of these come in for repair, all with the same problem. Transmit power good; receive O.K.; but no modulation. Found ALL with bad connection inside the mike plug. Requires replacing of entire plug due to it being a molded unit. (J.V.)

COLT 870 SCHEMATIC

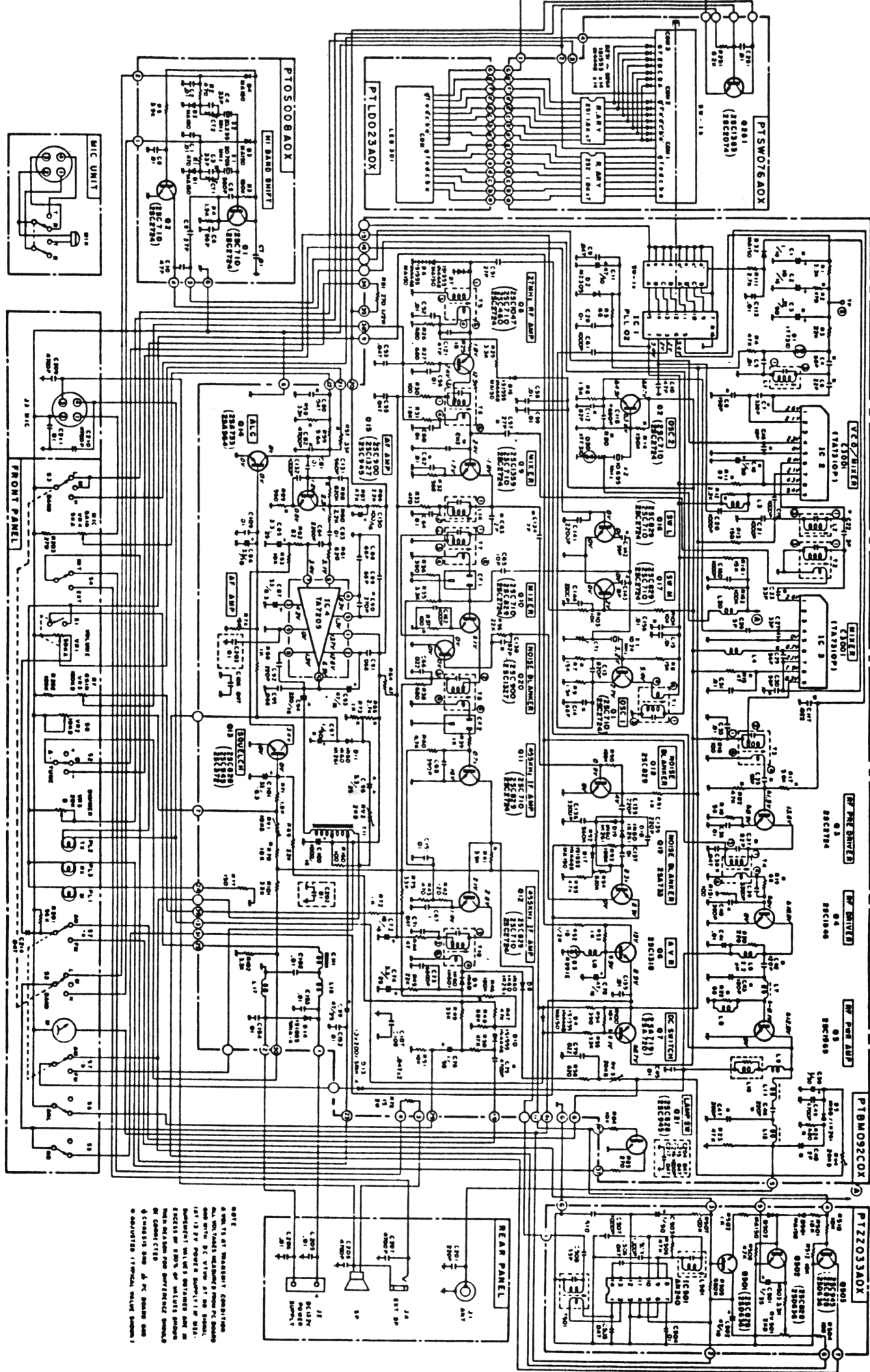

NOTE:
 1. UNLESS OTHERWISE SPECIFIED, ALL RESISTOR VALUES ARE IN OHMS.
 2. UNLESS OTHERWISE SPECIFIED, ALL CAPACITOR VALUES ARE IN P.F.
 3. UNLESS OTHERWISE SPECIFIED, ALL CAPACITOR VALUES ARE IN MICROFARADS.
 4. UNLESS OTHERWISE SPECIFIED, ALL CAPACITOR VALUES ARE IN MICROFARADS.
 5. UNLESS OTHERWISE SPECIFIED, ALL CAPACITOR VALUES ARE IN MICROFARADS.
 6. UNLESS OTHERWISE SPECIFIED, ALL CAPACITOR VALUES ARE IN MICROFARADS.
 7. UNLESS OTHERWISE SPECIFIED, ALL CAPACITOR VALUES ARE IN MICROFARADS.
 8. UNLESS OTHERWISE SPECIFIED, ALL CAPACITOR VALUES ARE IN MICROFARADS.
 9. UNLESS OTHERWISE SPECIFIED, ALL CAPACITOR VALUES ARE IN MICROFARADS.
 10. UNLESS OTHERWISE SPECIFIED, ALL CAPACITOR VALUES ARE IN MICROFARADS.

Heath Battery Eliminator Model IP-2715
Voltage Conversion/Reversal Protection
 by B.W.

This is a good unit; IF time was taken to assemble neatly!
 For a KIT is exceptional - But; there are a few faults.

1. No protection for regulator circuit if a device is hooked up backwards. Regulator board has 22 ohm resistor that will open up and show 25+ volts output, pegging the meter at same time.
2. Current meter is marked 25A, so everyone puts in a 25A fuse! WRONG, 20A Fast Blow is correct fuse.
3. No heat sink for Regulator I.C. - suggest mounting on rear chassis case and run wires to PCB. (Note: I haven't had any go bad due to suspect heat problems, just a precaution.)

Protection Modification:

Insert ECG-6022 Rectifier in series from center of Load Sw. to the positive output terminal. Drawing below is after modification.

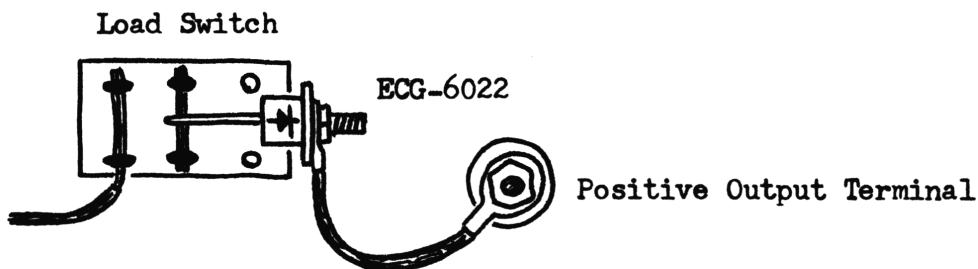

Voltage Modification: (*)

1. Remove R9 (1.3K $\frac{1}{2}$ W 5%) from adjust pot to meter. Replace with a 100 ohm $\frac{1}{2}$ W 5%, DON'T solder end to pot yet...
2. Exchange R8 (2K variable) with a 5K variable - wire up exactly as old pot wired. Solder new 100 ohm resistor to new pot.
3. Turn R8 (Voltage Adjust) fully CCW before turning unit on. When adjusting be careful not to exceed meter's range.

(*) Suggest replacing Voltage Meter with 30VDC unit, as new voltage output specifications are: 1.5-28.5VDC approx.

SPECIAL NOTE: Unit will power the Yaesu 757 with no problem!

02A "Export" Chassis

Everyone asking for schematic of PTOS011A0X PCB, see below:

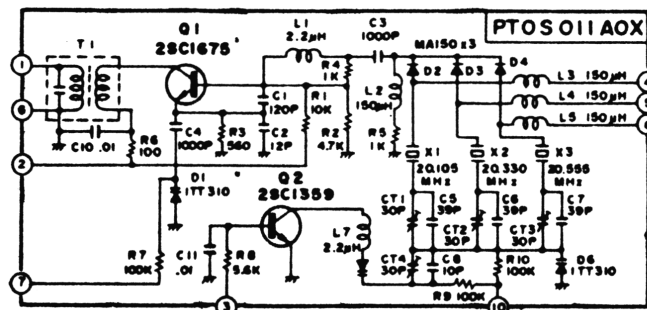

SUPER STAR 2000 SCHEMATIC

ALL VOLTAGES MEASURED FROM PC BOARD GROUND WITH DC VOLTAGE NO SIGNAL. ALL CURRENTS MEASURED WITH RESISTOR VALUE SHOWN. WHEN REASON FOR DIFFERENCE SHOULD BE CONTACTED FOR ASSISTANCE. * PC BOARD AND * ADJUSTED TYPICAL VALUE SHOWN.

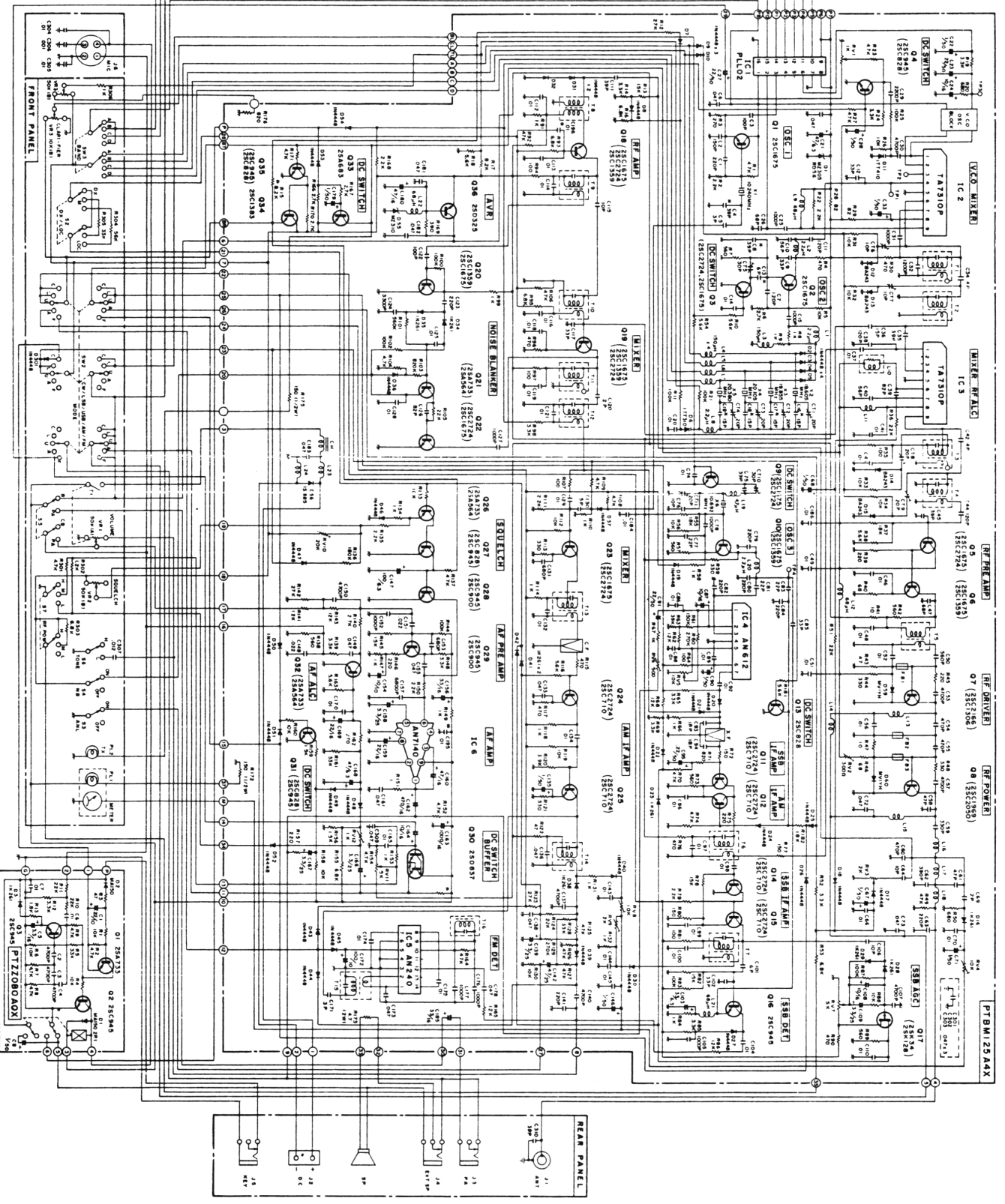
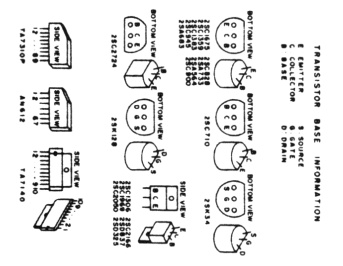
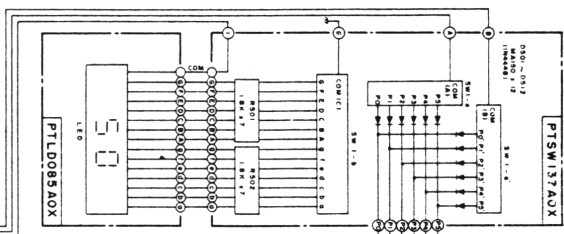

OAK CATV EQUIPMENT - CABLE TV "UNSCRAMBLING"

Some facts and fiction about OAK brand CATV equipment: OAK models N-12, M35B, TC35/TC35B, TC56/RTC56, V-26, KDM-400/RKDM-400 are all designed to use on what is known as SINE WAVE SCRAMBLING. A sine wave signal 270° out of phase with the horizontal sync pulse signal is modulated over the video signal to reduce the effective height of the horizontal sync pulse about 6 DB. This suppresses the sync pulse so that a TV tuned to this scrambled signal cannot lock its horizontal oscillator to the picture, making an unwatchable result on the screen. A variation of this system is known as VARI-SYNC SCRAMBLING: instead of only a 15,750 HZ signal being used as the scramble waveform-a randomly switched sinewave of either 15,750HZ or 31,500Hz is used to scramble the picture.

The converter box has a circuit to pick a correction waveform off the sound carrier of a given channel and apply it to the AGC of the converter and thus restore the video waveform to its original strength and make the horizontal sync pulse amplitude normal for the TV to utilize it.

Models TC35/TC35B, TC56/RTC56, and KDM400/RKDM400 are computer addressed by the CATV company to turn off the converters operation and descrambling ability if switched to channels not paid for. Many CATV companies perpetrate the false notion or rumor that they can tell the operation of the converter from their control center. While they do this to try to prevent tampering with their equipment-this is not true-the addressibility is strictly one-way--the CATV converter does not send back any signals to their computer controlled scrambling equipment! Any TOTAL CONTROL series OAK CATV equipment will function anywhere in the city its digital code appears in. Yes, your CATV converter will work at your neighbors or at a theifs house until you report it stolen or fail to pay your monthly cable bill!

Some CATV companies utilizing TOTAL CONTROL series model converters use what is known as PSEUDO-SCRAMBLE switching to prevent the use of modified unauthorized equipment that customers may buy mail order. This means that jumped-on decoders will scramble basic channels and descramble premium channels only part of the time. Authorized boxes receive signals to tell the boxes descrambling circuit to switch on and off as necessary to function.

The ASM series modules receive the signals telling the box to turn on or off the descrambler for the channel switched to while ignoring the digital code that tells the box if it is supposed to function on the channel it is tuned to. Thus a box with the ASM switching module installed will function on all standard and premium channels offered in the CATV system it is connected to.

Oak Model M35B units with Vari-Sync and ASM-2C modifications will function wherever the TC35, TC56 and KDM400 models are utilized by the CATV company. When furnished equipment is N-12, V26, V31 or M35B (or numerous other OAK discontinued models) the M35B-VS-ASM2C may need a manual control toggle switch because such systems may not have the computer control signals to tell the unit whether or not a given channel is scrambled. Occasionally CATV companies install channel traps that look like a coax jumper on one premium channel. This results in weak, snowy, black & white signals on the trapped channel and sometimes washed out pictures on the adjacent channel.

OAK CATV EQUIP. 'MOD.'

OAK Multicode M35B bottom (foil side) of main compartment

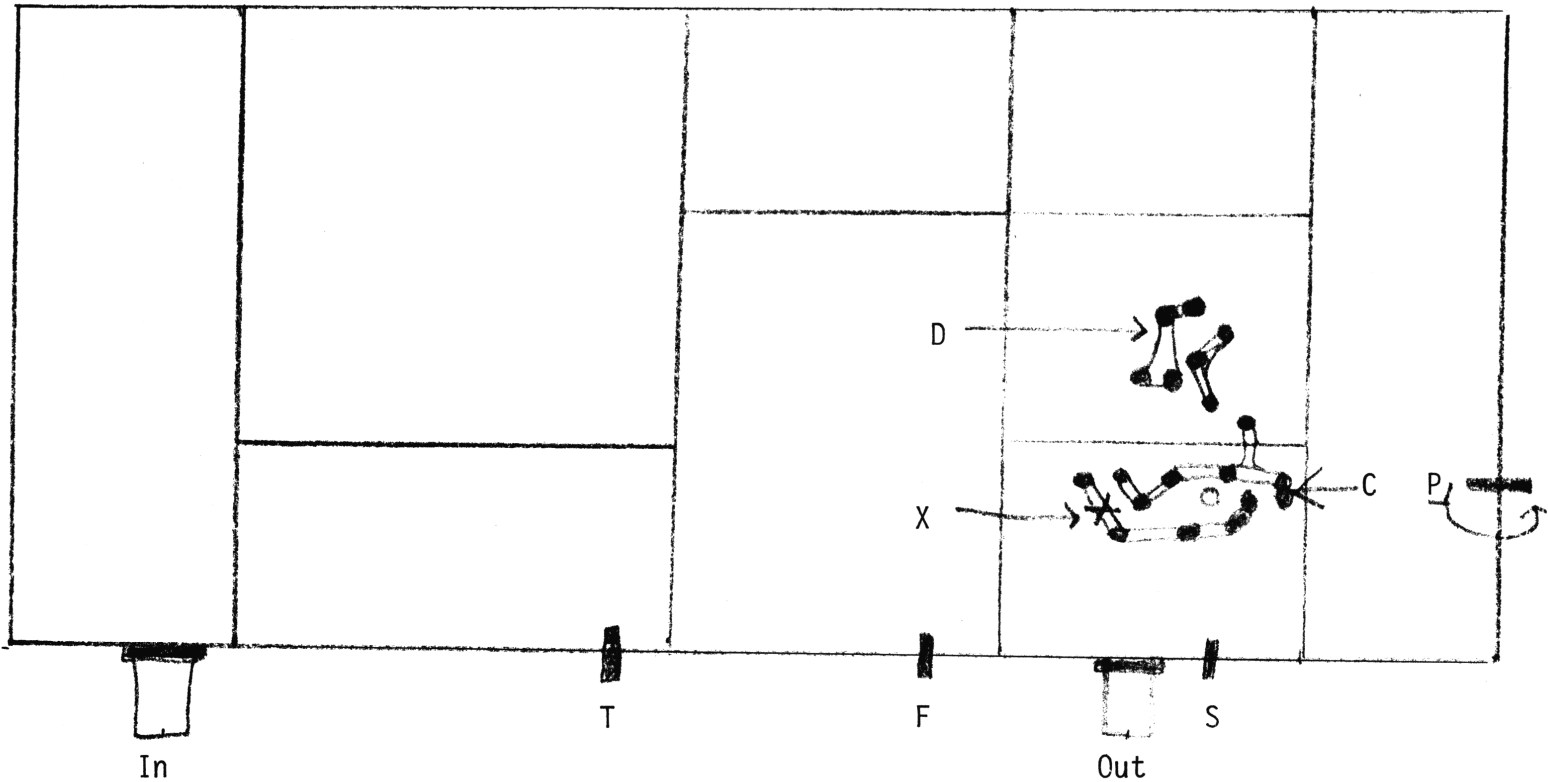

OAK CATV equipment uses "Sine-Wave" scrambling techniques. Model M35B has channels 2-13 plus channels A thru W. Channels A thru W are shown as 14 thru 36 on digital readout models of TV converter/descrambling equipment. Model M35B "Black Box" can be used when CATV furnished equipment is OAK models V-26, V-31, M35B, TC-56, RTC-56, KDM-400, or RKDM-400. Model M35B "Black Box" needs to have a vari-sync modification if being used in place of TC-56, RTC-56, KDM-400, and RKDM-400. The "Black Box" can also be used in place of OAK N-12 Mini-Code descramblers as well as TC-35, RTC-35 RPM-35 and other OAK models.

VARI-SYNC MODIFICATION

Vari-Sync modification is required if the encoding equipment switches between 15,750 Hz and 31,500 Hz scrambling signals. Refer to drawing above: Cut circuit foil at "X" as shown. Solder tuned circuit "Vari-Sync" Kit Parts across the cut in the illustrated foil trace.

Descrambler Turn-On Modification

Model M35B units have a channel selector switch which CATV companies program connections on to select which channels function for descrambling and which channels work only as standard-non-premium channels. Refer to drawing above: Point "S" is a feedthru cap with a (usually green) wire leading to the channel selector switch. To enable the user to manually select decoder operation simply cut this (green) wire and install a SPST switch (Vanco SM-25) in series across the cut wire. When the switch is ON the box will be in the "standard" mode. If the switch is OFF the box functions in the "premium" mode.

ASM-2B Automatic Switching Module Installation

ASM-2B is designed to fit vertically behind the front panel in front of the individual channel tuning pots. "T" is the testpoint for tuning voltage for channel alignment. "F" is the AFC testpoint which must be shorted to ground before attempting channel alignment. "P" is +24VDC to connect to "+" of module. "C" is the collector of Q353 and hooks to module output. "D" is D351 cathode for module input. "-" lead is ground and can be soldered to chassis. No connection to test points of module.

Bottom View of Blue potted Module of OAK TC-56 & RTC-56

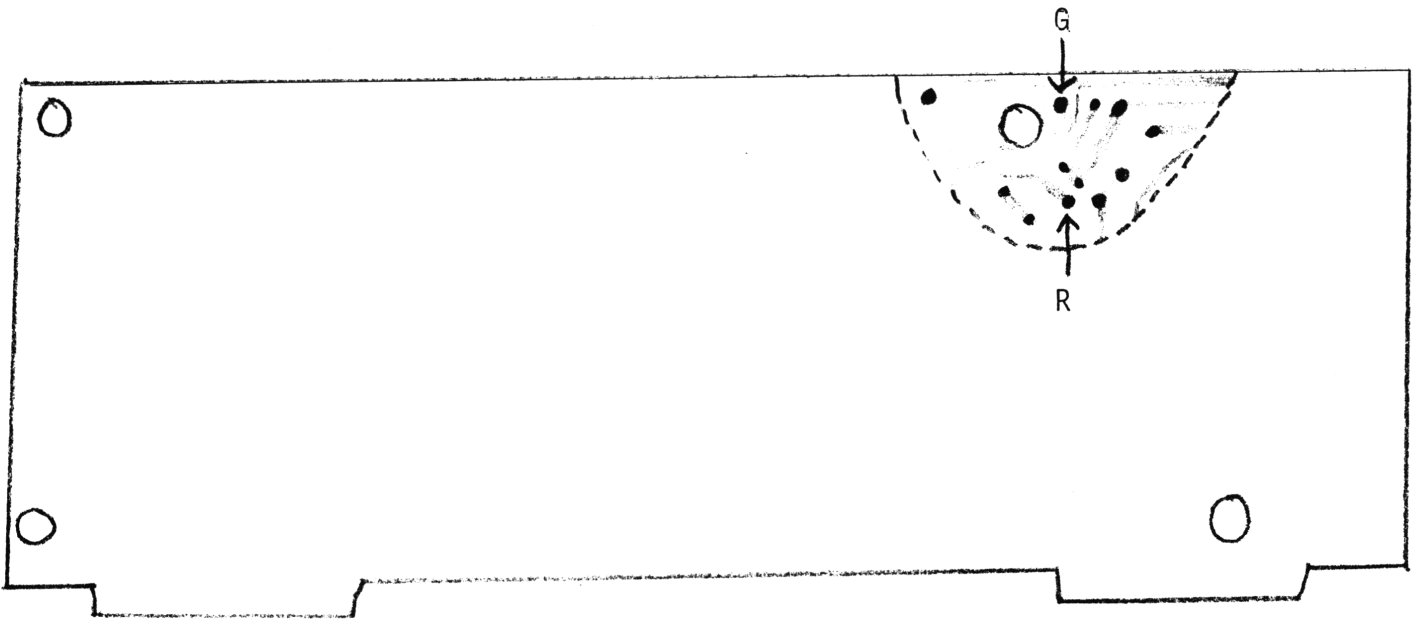

To turn on this model OAK TOTAL CONTROL computer tag addressed converter/descrambler requires chipping away some of the blue epoxy as illustrated in figure above. Add a 33 ohm 1/4W or 1/2W resistor from point R to point G (ground) as shown. Turn blue module back right side up and find 7 pin plug going to main circuit board. One of the seven wires is blue-this blue wire needs to be cut in two or pulled out of its plug. Also on the top of the blue module are a pair of coax leads with RCA plugs, a small 1K white pot, and 2 IF style cans. The white pot needs to be turned to its extreme clockwise position. Do not tamper with the tuning cans as these peak the 15,750 and 31,500 correction signal sine waves. Next to the shorter coax is a coil labeled L216 on the main circuit board. The end of L216 next to the jack this shorter coax plugs into is the point for "O" (output) of the ASM-1B. (This jack will be labeled J-5 AGC IN.) Underneath the blue module is a small circuit board with 3 IC's mounted on short plastic snap-in standoffs. Pin 7 of U901 (MC14538B) on this small board goes to "I" (input) of the ASM-1B. A red wire labeled "+5V" is the "+" source for the ASM-1B and a black wire is the "-" (gnd.) source for the ASM-1B. (The red "+" and black "gnd" wires are on the small board containing U901, U902, and U903). Model ASM-1B comes with a red LED between "+" and "L" on it.

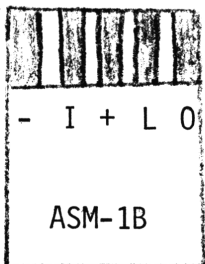

Model ASM-1B
automatic
switching
module for
OAK TC-56

Model ASM-2B
automatic
switching
module for
OAK M35B

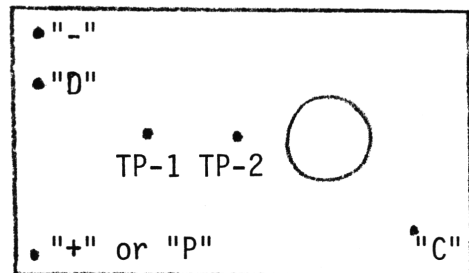

The reason model ASM-1B and ASM-2B were developed is because many CATV companies use "pseudo-scrambled" techniques to "jam" the customer owned equipment and try to make it useless. These automatic switching modules decide whether the box should be in the standard or premium mode at any given instant. These modules switch practically instantly preventing the loss of any program scenes due to the efforts of CATV companies to make the use of customer owned equipment impractical. These modules work only on the OAK models that hookup instructions are given for and will not function with other brands of CATV equipment.

SHARP CB-2460: Vol. 11, pg. 17 is correct as written for 4PDT relay.

For DPDT relay use the wiring diagram below may be used.....

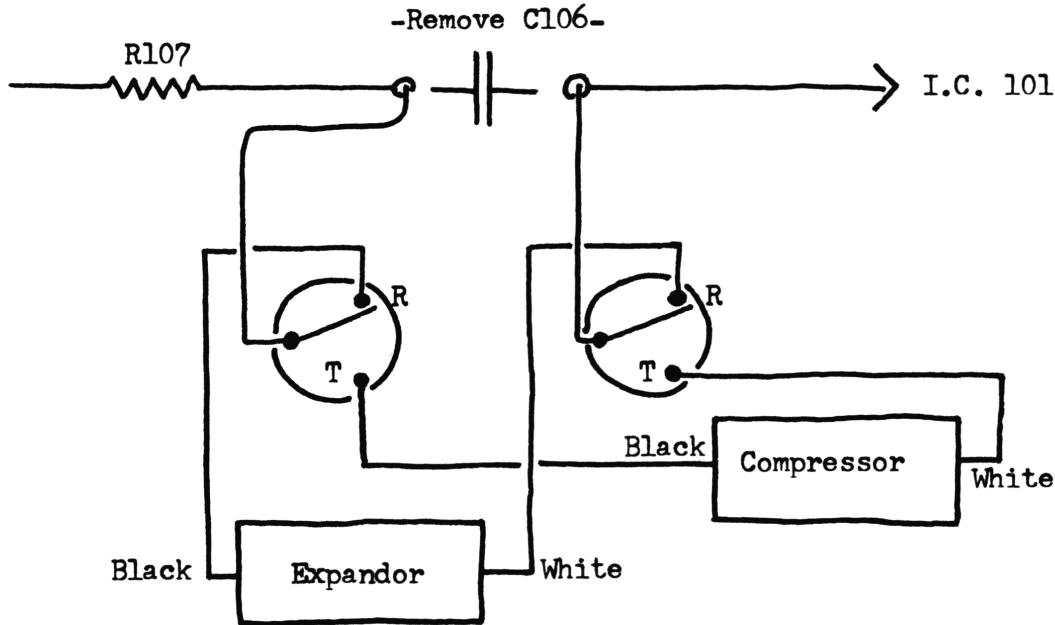

Wire the relay up as shown above, keying line below:

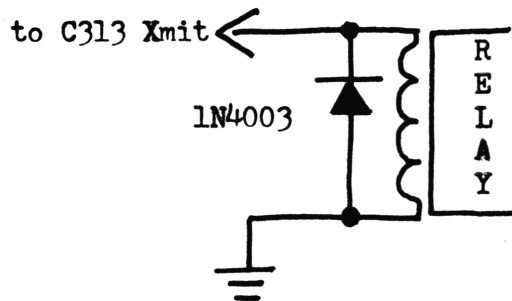

SPECIFIC TUNEUPS

Sears 23, 934-3671160: RT1-RF Gain, RT2-RX Mtr., RT3-TX Mtr.
Tune T1, T11, T12, T13, T15 for max forward. AMC disable is D7.
If final goes bad, don't replace with same 2SC1909! Use a 2SC1306.

Sears 663-38030050, TC9109BP-PLL: VR1-RX Mtr., VR2-Sq Rng, VR3-TX Mtr.
Has 2SC2028 Driver, 2SC2029 Final, with mica insulators. Rejection is very good. AMC defeat is D7.

G.E. 3-5816A, TC9109BP-PLL: RV1-TX Mtr, RV2-RX Mtr, RV3-Sq Rng, RV4-AMC.
Coils L5, L6, L7, and L8 are not tunable - spread or compress for max forward output.

U.S. Versions - MB8719/MB8734 PLL Chassis

We keep getting additional "break thru modifications" all the time???

But nothing new - as is 're-hash' of old printed material from prior issues. The most complete material may be found in volumes that had the radios featured which contained the PLL chip.

Units which contain the MB8719 or MB8734 PLL chip are listed for reference - all known at present time.

Realistic: TRC-450, TRC-490
Teaberry: Stalker IX, XV, XX
Tram: D-80, D-300
Courier: Galaxy
Cobra: 140/142/148/2000GTL,
46/47/50/55XLR.

Robyn: SB505D (late version)
SBE: LCMS-8
Midland: 63-445, 79-900
President: NEW* Grant, Madison,
McKinley, Washington.

8719/8734 Modification Information

Different types of switching methods and frequencies obtained may be found in the following volumes: (U.S. Versions ONLY)..

<u>Volume</u>	<u>Page</u>
5	20, 24-27
6	1-2, 64
7	15-22, 49-50
8	12-13, 15-16, 33-37
10	25-31, 35, 39-40
11	15
12	14-15, 19-20
13	21-22, 32-33
14	11-17
15	25-28, 55-57
18	22-23, 47, 68

TRC-413 (21-1507) 40 Ch. Mobile.....(IC7132-PLL).

TX adjust in order: T10, T11, T12, L3 and L6. RX adjust in order: T1, T2, T3, T4, T5, T6, and T7. If you have to, try R85(10K) for the AMC disable. Pwr increase: decrease value of R110 to about 2 ohms. For better rejection, remove CF1 (455KHz filter) and replace with 2 or more of the same type in series. VR2-Sq Rng, VR5-Rx Lights, and VR6-Tx Lights.

PC244 SCHEMATIC

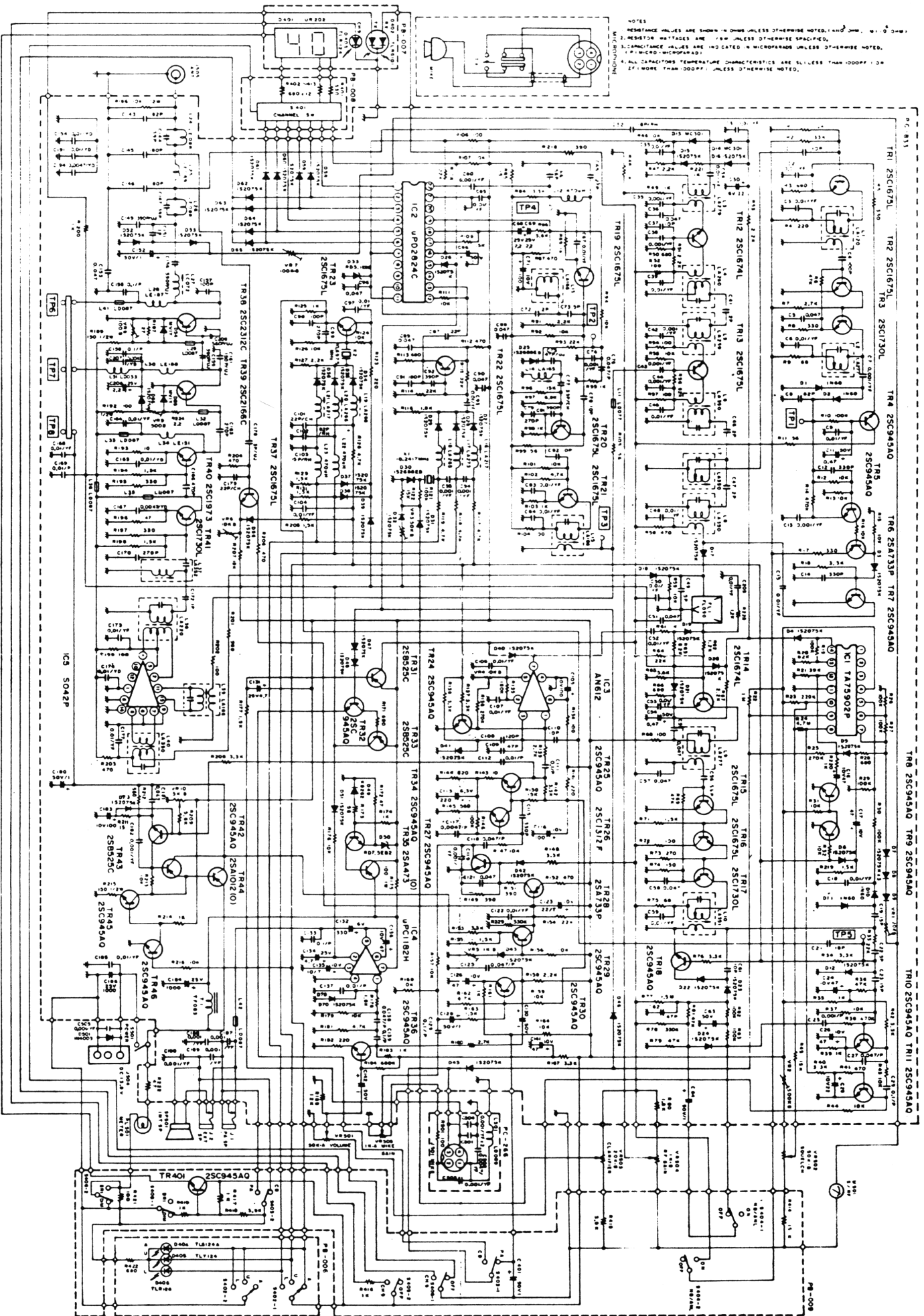

NOTES:
1. RESISTOR VALUES ARE SHOWN IN OHMS UNLESS OTHERWISE NOTED. 1K = 1000, 10K = 10,000, 100K = 100,000, 1M = 1,000,000.
2. RESISTOR RATINGS ARE 1/4W UNLESS OTHERWISE SPECIFIED.
3. CAPACITOR VALUES ARE IN MICROFARADS UNLESS OTHERWISE NOTED.
4. MICROFARAD = 10⁻⁶ FARAD.
5. ALL CAPACITORS TEMPERATURE CHARACTERISTICS ARE UNLESS STATED OTHERWISE.
6. IF MORE THAN 100PF, UNLESS OTHERWISE NOTED.

COBRA 146GTL SCHEMATIC

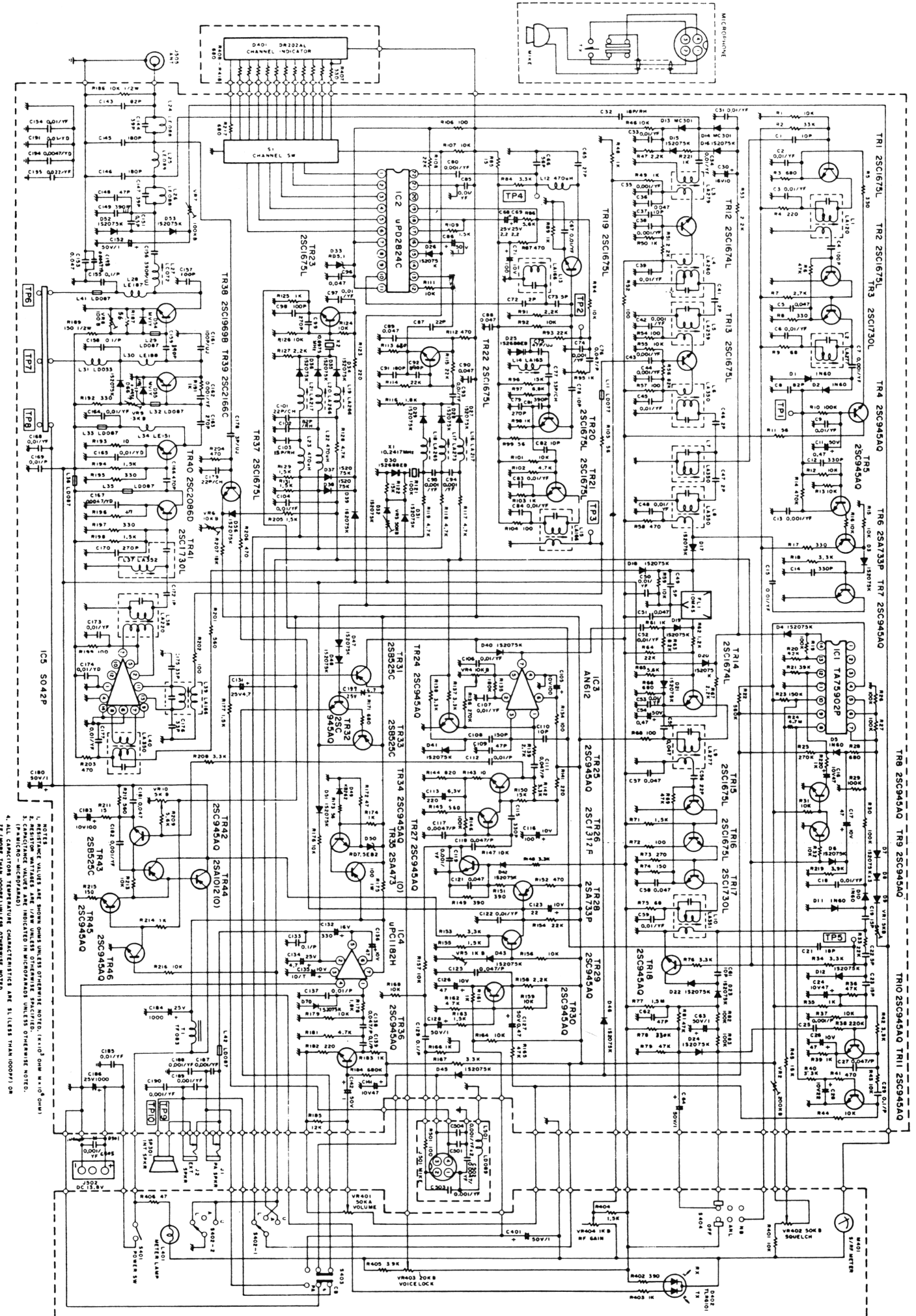

NOTES:
 1. RESISTOR VALUES ARE SHOWN OHMS UNLESS OTHERWISE NOTED. (K=10³ OHMS, M=10⁶ OHMS)
 2. RESISTOR VALUES ARE /W UNLESS OTHERWISE SPECIFIED. OTHERWISE NOTE.
 3. CAPACITANCE VALUES ARE INDICATED IN MICROFARADS UNLESS OTHERWISE NOTED.
 4. ALL CAPACITORS TEMPERATURE CHARACTERISTICS ARE 5% (LESS THAN 100PF) OR 20% (IF MORE THAN 100PF) UNLESS OTHERWISE NOTED.

SECRET CB INDEX - VOLUMES 1 THRU 20

CODES: A - ALIGNMENT PROCEDURE; C - CONVERSION; FC - FREQUENCY CHART; M - MISCELLANEOUS INFORMATION;
S - SLIDE; SC - SCHEMATIC; T - TUNE UP.

VOL/PG	VOL/PG	VOL/PG	VOL/PG
MISCELLANEOUS:	BROWNING	COBRA (cont.)	CRAIG
Conversion tips for all SSB Radios.....9/7	BARON...S-15/15-17;M-19/52	148GTL-DX.....C-15/20-24	L101.....T-6/20;11/42
"A" Channel Mod. for all SSB Radios.....9/16-17	MARK III.....C-6/28C-16/50-51;17/47,54	L102.....T-6/20
Cybernet Freq. Mod....8/18	MARK IV....C-6/29-30;7/8-14	...C-18/13,17,23;19/37,46	L131....C&S-9/12-14;T-10/59
Uniden MB8719 Mod.....8-15	MARK IVA....C-7/8-14;14/5-6	..SC-19/27-28;T-16/43-49	L132....C-9/12;10/47;11/10
MB8719 Mod...10/25-26;18/68	SABRE.C-1/27;T-14/42;M19/52	.A-17/55-58;M-18/26;19/68S&T-9/12;10/47
MB8719 w/11.1125 Mod..11/15	CHANNEL MASTER	150GTL.....T-17/42;M-19/31	L231.....C-9/12-14;T-10/60
Update.....14/11-12	CB6830.....C-14/41;T-16/55	1000GTL.....T-6/18;14/42S-9/12-14;12/3
PLL Q1A Mod.....9/15-17	CB6834.....T-14/44	2000 (C.A.P.).....C-6/23	L232.....C&S-9/12
PLL Q2A Mod.....3/13-15	CB6835.....T-6/18	2000GTL.....C-5/20;7/15-17C&S&T-10/47;11/10
PLL Q2A Mod...4/54-55;18/56	CHRYSLER	...C-18/29;C&S&T-15/25-28	L321.....C&S-14/12
O2A Truth Table...15/12-13	4048076/8077.....T-6/18S-12/20;13/40	4102.....T-16/32
23 ch. O2A AM conv....12/32	CLARION	COLT	DAK
Tech Tips on the 858	DMA066.....T-3/45	SX33.....C-3/4-7	MARK II.....T-10/60
Chassis.10/55;19/59,60,67	JC202E.....T-3/45	222.....T-6/20	MARK V.....T-12/34
Uniden 858 Update...9/8-11	RCJ003.....T-3/45	290.....C-3/4-7;T-3/4	MARK IV...C-5/21-23;9/18-19
How to get on 28 & 29 MHz	TC203E.....T-6/18	320FM.....A-19/48-51	MARK X...C-4/39-46;S&T-4/45
w/uPD858 PLL.....11/4-7	COBRA	350.....T-14/46	DEMCO
uPD858 AM Conv.....11/35	CAM89....C-14/45-46;T-14/45	355.....T-18/19	STAR II.....C-5/60
Receiver Widebanding for	18LTD.....T-20/36	390.....C-3/4-7;T-3/4	SUPER SATELLITE.....C-5/60
858 Chassis.....13/34	19.....T-7/51	480.....C&S&T-3/8-15	EVERSONIC
Thumbwheel conv. for	19GTL.....T-12/34C-5/39;T-3/58	DK-222.....T-19/42
858 Chassis.....13/35-37	19XS.....T-18/51	485.....C&S&T-3/8-15	FANON
How to increase ANL	20LTD.....M-20/42C-4/49;T-6/19	10-40.....T-6/20
efficiency 70%.....11/8	21(23 ch).....T-20/36	510.....A-18/44-45;SC-17/45	FANFARE 125F.....T-3/45
Ham Radio Crystal	21GTL.....T-3/41,58T-17/42,45	FANFARE 182F.....T-3/41
Selector.....12/24	21XLR.....T-1/20;10/58	800....C-3/4-7;T-3/4;10/58	FANFARE 184DF.....T-3/47
SM5104 AM Chassis..18/20-21	25GTL.....T-3/41,58	1000....C&S&T-3/8-15;T-3/58	FANFARE 185PLL.....T-3/46
SM5104 SSB..6/26-27;9/20-22	25LTD.....T-17/35	1200.....T-9/30-31;16/55	FANFARE 190DF...T-3/47;7/51
For most 23 ch. radios	29GTL.....S-13/57;19/40	COMMANDO	FANFARE 350F...C-5/57;S-5/55
see crystal cross ref.T-3/45;14/42	2340.....T-1/21T-3/47;13/12
guide.....1/6-18;2/5-13	29LTD.....T-13/59	COMMTRON	GEMTRONICS
Phase Lock Loop Xtal	29XLR.....T-1/20	XII.....A-18/44-45;SC-17/45	GTX-23.....T-15/61
Cross Ref. Guide...6/1-2	32XLR.C-4/47;M-19/52;T-3/58	CONVOY	GT44.....T-2/42
AIR COMMAND	45XLR.....C-18/67;T-12/34	CON-400.....T-3/58	GT55.....T-3/48
CB-640.....T-5/38	46XLR.....T-3/43	COURIER	GTX66.....T-6/21
ALARON	47XLR.....T-3/45	BLAZER 40D.....T-3/58	GTX77...C-5/39;S-4/49;T-6/21
B-4075.....T-9/30	50XLR.C-16/53,18/22;T-3/43	CARAVELLE.....T-18/65	GTX2325.....C-15/29
B-4900.....T-9/30	55XLR..C-16/53,18/22;T-3/43	CENTURION.....S-1/61;5/55	GTX3323.....T-17/59
B-5050A.....T-9/30	66GTL.....T-10/58	CENTURION PLL.C-1/31,61-62	GTX4040.....T-3/48
B-5200.....T-3/41	77X.....T-9/30C-5/57	GTX5000.....T-3/42;13/60
AMERICAN MOTORS	78X.....T-4/49;6/19;8/44	CENTURION 40D...C&S&T-10/53	FIELDMASTER
3221847/48/49/50....T-12/34	85.....T-15/61T-13/10	MICRO MINI 40.....C-11/37
AUDIOVOX	86.....M-19/52	CHIEF 23.....T-18/65A-20/39;SC-20/58
MCB750.....T-3/41	86XLR.....T-3/45	CLASSIC II.....T-18/65	TR-40.....C-15/63
MCB5000.....T-11/42	87GTL.....T-6/19	CLASSIC III.....T-18/65	GENERAL ELECTRIC
MCU6000.....T-6/18;15/60	87XLR.....M-19/52	CLASSIC PLL40..T-3/43;10/59	3-5800A.....T-3/50
AUTOMATIC	89GTL.....T-6/18	COMET 23.....T-18/65	3-5801A.....C-16/33;17/39
CBH2265.....T-3/41	132-A.....S-1/28	CONQUEROR.....T-18/65	3-5804B.....T-6/21
BETA	132-B.....C-1/53	GALAXY.....C&S-7/18-22	3-5804F.....T-10/61
23 Deluxe.....T-16/32	132XLR..C-4/47;T-3/45;16/39	GLADIATOR PLL..C-1/31,61-62	3-5804G.....T-12/35
BOWMAN	C-19/52;S-10/45-46;15/15-17S-1/61;5/55	3-5805A.....T-9/31;10/61
CB555.....T-3/44	135-A.....S-1/28	NIGHTRIDER 40D.....T-3/46	3-5806.....T-18/65;19/64
CB750.....T-2/43	135-B.....C-1/53;S-1/29	RANGLER 40D.....T-3/58SC-19/65
CB755.....T-14/44	135XLR...C&S-4/38;10/43-46	REBEL 23+.....T-18/58	3-5811B.....T-9/31;10/61
CBH900.....T-3/44	C-18/40-41;S-8/38;15/15-17	REDBALL.....T-1/21	3-5812A.....T-10/61
CB910.....C-11/41;13/58	M-19/52;T-3/45;4/38;16/39	RENEGADE 40.....T-3/46	3-5813A.....C-14/41
.....T-1/21;3/44	138.....S-1/28	ROUGE 40.....T-3/43	3-5813B.....T-18/34
CB920.C-14/43;T-1/21;14/43	138XLR.....C&S&T-1/20-23	SPARTAN....C-5/30,53,55,57	3-5814B.....T-6/21
CB930....C-3/21;T-1/21;3/44	139.....S-1/30;T-1/20	...C-1/61-62;S-1/61;5/55	3-5817A.....T-7/51
CB950..C-5/39;S-4/49;T-3/43	139XLR.....C&S&T-1/20-23	TRAVELLER II.....T-18/65	3-5818A.....T-2/42
CBH990.....T-5/43	140GTL...C&S&T-4/50;S-6/64	COYOTE	3-5819A.....T-11/42
CBR9600.....T-2/42;3/41C&T-3/19-20;T-3/58	23.....T-16/32	3-5821A.....T-9/31
CBR9940.....T-3/44C&S-10/28-29	CPI	3-5821B.....T-3/54
CBR9950.....T-10/58	142GTL...C&S&T-4/50;S-6/64	300.....C-8/21	3-5825A.....T-9/31-32
BRISTOL	...C&S-10/28-29;S-8/35-37	400.....C-8/21;T-10/59	3-5825B.....C&S-20/55
BCB-2271.....T/16/41	146GTL.....C&S-11/17-18	2000.....C-3/25	3-5826A.....S-20/54
C-15/18-19;S&T-10/41	2000 LOW.....C-9/23	3-5830.....T-3/42
	148GTL....C&S-8/16;C-18/29	2500.....C-5/37-38;S-5/37	3-5869A.....C-14/41;T-2/42
T-6/19		3-5871A.....T-13/60
	148GTL-B..C-17/40-43,19/60		
SC-17/43;T-16/55		

VOL/PG
GENERAL ELECTRIC (cont.)
 3-5871B.....T-3/46
 3-5875A..C&S&T-10/48;T-9/32
 3-5900A.....T-12/35
GENERAL MOTORS
 CBD-20U.....T-12/36
 CBD-203.....T-3/48
 DELCO AM/FM/CB..C-11/38-40
 70BFMC3.....T-2/43
 80BCB2.....T-6/20
 90BCB1.....T-10/60
 90BFMC1.....C&T-12/26
 90BFPC1.....C&T-12/26
 90BFTC1 AM/FM/CB...T-10/60
 91YFMC1.....C&T-12/26
 4120.....T-3/46
 4145.....T-9/32
 4175.....T-3/46
GLOBEPHONE
 GS-480DX.....C-20/36
A-20/39;SC-20/58
GREAT
 K605.....T-16/32
 GT818.....T-16/32
 GT838.....T-18/65
HALLICRAFTER
 HCM271.....C-5/50-51;6/39
HAM INTERNATIONAL
 CONCORDE II.....A-19/48-51
 MULTIMODE 3.....SC-20/52
HYGAIN
 I-A.....C-1/22
 PLL.....C-1/32
 II.....C-8/20
 IV 673.....T-18/34
 HY-RANGE V.....T-18/51
 V.....S-11/11
 V-EXPORT.....A-19/48-51
 VIII.....T-3/59
 623.....S-1/33
 674A.....S&T-4/60
 V-674B.....T-1/21
 2701.....T-2/42
 2702.....T-3/48
 2703.....T-3/48
 2716.....T-12/36
ITT
 CB-4000M.....C&T-13/61
 CB-4400M.....C&T-4/17-18
JC PENNEY
 PINTO SSB.....S-1/44
 6241.....T-18/51
 6246.....C&T-13/61
 6247.....S-13/13
 6248...C-8/24;S&T-13/14-15
 981-6203.....T-15/30
 981-6204.....T-9/32
 981-6225.....T-14/47
 981-6235.....T-19/42
 981-6331.....T-20/41
 981-7461.....T-9/32
 981-8360.....T-10/61;18/51
JIL
 615CB.....T-11/42
JOHNSON-MESSENGER
 40.....T-12/36
 50.....T-7/51
 80.....T-7/51
 123A.....T-1/21
 132.....T-19/42

VOL/PG
JOHNSON-MESSENGER (cont.)
 352-VIKING.....S-1/34
 4120.....T-3/47
 4125.....C&T-13/61
 4135.....T-3/48
 4140.....C-15/31;T-3/54
 4145.....T-3/54
 4170.....T-3/47;11/43
 4174.....C&T-13/61
 4175.....T-3/47;11/43
 4250.....T-3/48
 4730.....C&S-10/49-51
 VIKING 200.....T-12/36
 VIKING 260/270.....T-3/49
 VIKING 4330/4360...T-11/43
 VIKING 4740.....C&S&T-11/12
KENWOOD
 TS-120S.....C-12/22
 TS130.....C-12/23
 TS-430S.....C-18/24-25
 TS-530S.....C-15/32
 TS-820S...C-14/7-8;15/32-34
K-40
 K-40 AM.....T-15/60
 K-40 SSB.....S-20/61
KRACO
 KCB1401.....T-18/57;19/42
 KCB2320.....T-20/36
 KCB2330A.....C-9/15
 KCB2340.....T-2/42
 KCB2345.....T-18/34
 KCB4000.....T-11/43
 KCB4003.....T-3/42
 KCB4005.....T-9/38;11/43
 KCB4020.....T-3/49
 KCB4030.....T-8/44
 KCB4045.....T-14/47
 KCB4080.....T-3/50
 KCB4090.....C-19/52
 KCB4095.....C-19/52
 KCB4806.....C-15/59
 KCB4088.....T-3/50
KRIS
 XL25.....T-2/43
LAFAYETTE
 COMSTAT.....T-11/45
 DYNA-COM 40.....T-11/44
 CHB740.....T-15/60;16/55
 HB640.....T-2/43
 LM-100.....T-12/36
 LM-300.....T-12/37
 MICRO-723.....T-19/42
 SSB75.....C&S&T-14/9
 SSB140.....T-11/44
 TELESTAT 1240.....T-5/14
 2400 FM.....M-19/59
LAKE
 400.....C-16/52;19/33
 410.....T-12/37
 450.....T-12/37
 600.....T-12/37
MAJOR
 MI20...SC,T,FC-19/23,29,43
MARCO
 CB-444...SC,T,FC-19/21,30,43
MECCA
 BCB-6 (23 ch).....T-20/41
MECTRON
 ME400.....C-17/34
 ME502.....C-14/41

VOL/PG
MEDALION
 63-240.....T-3/50
MIDLAND
 CAP 858.....C-5/30
 100M.....T-10/67
 102M.....T-14/42,17/59
 103M.....T-17/65
 150M.....T-7/52
 13-857.....C-11/36
 13-858.....T-14/42
 13-862.....C&T-14/48-49
 13-863B.....T-20/41
 13-867.....T-13/62;19/42
 13-879.....T-14/50
 13-881.....T-15/61
 13-882C.....C-13/62;15/35
T-13/62
 13-883B.....C&S-12/4
 13-892..S-4/48;11/13;T-4/48
 13-893.....S&T-4/51
 13-898.....S-1/36
 13-898B.....S-1/35
 63-445.....T-11/45
 76-858...C-16/21-24;T-3/49
 76-860.....T-14/51
 76-863.....T-3/50;9/33
 77-101B.....T-8/44
 77-101C.....T-12/38
 77-808.....T-18/51
 77-821.....T-3/42
 77-824.....T-8/44
 77-824B.....T-12/38
 77-824C.....T-12/39
 77-830.....C-20/56
 77-838.....T-9/33
 77-849.....T-3/50
 77-853.....T-16/55
 77-856.....T-11/45
 77-861...C-12/26;T-3/50
 77-861B.....T-11/45
 77-865.....T-9/33
 77-899.....T-9/33
 77-963.....T-3/42
 78-574.....C&S&T-14/10
T-9/38;12/39
 78-999.....S&T-12/5
 79-891.....S-12/6;T-12/5
 79-892.....C-15/36-38
S-11/14;T-3/49
 79-893.....C&T-2/20
 79-900...C-5/47;18/62
S-5/47;T-9/33-34
 1001.....T-17/65
 2001(Export)..SC&T-19/26,29
 3001.....T-12/37
 4001.....T-7/52
 5001.....T-12/37
 6001...C-11/16;16/60-62
S&T-11/16
 7001...C&S-8/21;C&S&T-11/16
C-16/60-62
 7001(79-007)....T-11/45-46
MOPAR
 4094173.....T-3/51
 4094176.....T-3/51
 4094177.....T-3/49
 4094178.....T-3/60
MORSE
 2001.....T-14/42
 3005.....C-2/27
MOTOROLA
 CB555.....C&S&T-12/7
 CC975AX.....T-16/40

VOL/PG
MOTOROLA (cont.)
 CF925AX.....T-11/46
 CM540.....T-18/27
 MOCAT 40.....T-11/46
 T4000A/05A/10A/20A...T-3/50
 T4025A.....C-10/46
MULTIPLEX
 Same as PALOMAR 2400
NESCO
 1249.....C-6/38
N. D. I.
 PC-102.....T-11/46
 PC-200.....T-7/52
 PC-201.....S&T-12/8
OMNIVOX
 CB-1000.....T-18/66
PACE
 CBI44.....T-14/42
 CBI66..C&T-15/42&60;T-19/42
 1000.....S-1/37-38
 1000MC/1000BC...C-15/39-41
 DX1023B.....S-1/39
 2300C.....C-19/33
 8003.....T-11/47
 8008.....T-2/43
 8010A...C-15/43;17/60-61
 8015A...C-15/43;17/60-61
 8016.....T-11/47
 8025...C-15/44;T-19/42
 8041.....T-19/33
 8046.....T-9/33
 8092...C-6/35-36;S-6/37
 8093.....C-15/48
 8113.....T-12/39
 8117.....T-11/47
 8155...C-15/43;19/33
T-9/34;12/40
 8193...S-12/9;T-7/52
PACIFIC
 800 SSB...C-18/16;19/57-58
S-18/15;T-16/55;19/29
SC-19/25
PALOMAR
 49.....T-3/60
 500...C&S&T-4/19-20;5/32-36
C-8/21
 500B.....T-18/67
 2400 (EXPORT)...A-18/30-33
M-17/42;SC-20/38
 4100.....T-3/54
 5000(re: 2400)....M-20/64
PANASONIC
 CR-B474EU(AM/FM/CB)..T-9/34
 RJ3150.....C-18/18
 RJ3200.....T-14/42
 RJ3250.....T-11/47
 RJ3600...C-10/57;T-11/48
 RJ3660.....T-14/52
 RJ3700...C&S&T-13/16-17
PEARCE-SIMPSON
 BENGAL.....S-1/40
 CHEETA...C-1/31-32;S-1/40
 COUGAR 23.....T-14/53
 JAGUAR 40B.....T-19/42
 LEOPARD B.....T-3/49
 PUMA 23B.....T-13/62
 SIMBA...C-1/31-32;S-1/40
 SUPERTIGER 40A.....T-3/60
 TIGER 23C.....T-20/41
 TIGER 40A.....T-9/34

PIONEER
 GT-100G AM/FM/CB...T-10/62

PRESIDENT/UNIDEN
 ADAMS...C&S&T-2/16;13/18-20
 ANDREW J.....T-9/34
 DWIGHT D.....S-15/62
T-10/62;14/54
 GRANT (OLD)C&S&T-1/22-23,59
C&S-2/17,23-26
 GRANT (NEW)...C&S&T-5/24-27
C&S-13/21-22;S-8/34
 Home Ch. Conv....14/13-17
 GRANT-DX.....C&S-19/34-36
SC-19/24;T&M-19/29,68
C-20/22,40;S-20/24
A-20/47-51
 JACKSON-DX.....C-20/31-35
A-20/43-46;T-19/30
S-20/28-29;M-20/30
FC&SC-19/8-9
 JAMES K.....T-7/52
 JAMES K (NEW)...T-12/40
 HONEST ABE.....C-1/60
 JOHN Q.....C-1/60
 MADISON (NEW)...C&S-10/30
 McKINLEY.....C&S&T-4/12-13
S-6/64
 McKINLEY (NEW)...C&S-10/29
 OLD HICKORY.....T-9/34
 TEDDY R.....C-1/60
 WASHINGTON,C&S&T-1/22-23,59
 WASHINGTON (NEW),C-10/28-29
S-6/64;8/33-34;10/28
 ZACHARY T...C-1/60;T-14/54
 AR 7.....T-12/40
 AR 44.....T-10/63
 AR 144,C-11/17-18;S&T-10/41
 AR 711.....T-12/34
 AX 7.....T-12/45
 AX 11.....T-12/45
 AX-14.....T-12/45
 AX 44.....T-12/45
 AX 52.....T-12/45
 AX 55.....T-12/45
 AX 144.....T-12/45
 AX 711.....T-12/40,45
 PC 3.....M-19/68
 PC 33.....T&M&SC-19/40-41
 PC 55.....SC-20/60;T-20/53
 PC 77.....SC-20/59;T-20/53

RAY JEFFERSON
 CB-845.....C-12/27;T-11/48

RAIDER
 4060.....C-15/46

RCA
 14T270.....T-9/36
 14T300.....T-2/43
 14T302.....C-4/36;S/11,39
S-4/49;T-3/53
 14T303.....T-11/48

REALISTIC/TRC
 45A.....T-4/37
 47.....S-1/41;T-1/21
 48.....S-1/42
 57.....C-20/42;S&T-12/28
 83.....T-19/42
 99A.....T-4/37
 100.....T-4/37
 180.....T-4/37
 200.....T-4/37;10/63
 204.....T-10/63
 205.....T-12/40
 206.....T-14/55;19/42

REALISTIC/TRC (cont.)
 209.....T-10/63;12/49
 210.....T-16/32;M-19/47
 211.....T-17/34
 212.....T-17/34
 410.....T-12/29
 411.....T-15/60
 412.....T-19/42
 414.....T-19/42
 420.....T-12/41
 421.....T-8/44;12/41
 421A.....T-9/35
 422.....T-8/45
 422A.....T-10/64,67
 424.....T-3/57;9/35
 425.....T-7/53;10/67
 426.....T-10/64
 427.....T-8/45
 428.....T-11/48
 431.....C-7/23-24;T-4/37
C-20/8-15
 432.....T-11/48
 440.....T-8/45;9/35
 441.....C-20/23,42
T-10/67;11/49
 448.....C-11/19;16/25-30
S-11/19;17/54
T-3/51;10/64;11/19
 449.....T-3/51;9/35-36
 450.....C&S-10/31
 451..C&S&T-12/10-13;T-18/26
 452.....T-1/21;3/52
 454.....T-8/45
 455..C-12/30;C-20/23;T-3/60
 456.....T-10/67
 457..C&S&T-10/36;T-9/35-36
 458.....S-8/39-40;T-9/35
 459.....C&S&T-10/32-35
 461.....T-3/51
 462.....T-9/36
 466.....T-3/51
 468.....T-3/57
 470.....T-9/39;12/41;16/40
 471.....T-8/45
 473.....T-20/53
 480..C&S&T-10/37-38;T-7/53
 490..C&S&T-12/14-15;T-11/49

REGENCY
 CR240.....T-16/32

ROADRUNNER
 CB5000A.....T-16/41

ROBERTS
 40 Ch.....T-14/42

ROBYN
 007-140.....T-3/52
 AM500D.....T-3/52
 DG130D.....T-3/56
 GT-410D.....T-3/57
 GT-440D.....C-1/23
 LB120.....T-3/52
 SB-505.....C&S&T-5/41-42
 SB-520D.....C&T-2/21-22
 SB-540D...C-5/19,36;7/25-28
S-5/19
 SX-401.....T-3/57
 SX-402D.....T-3/57
 T240D.....S&T-13/63
T-3/56;13/60
 WV-23.....C-1/24-25
 WV-110.C-12/31;T-3/56;11/50

ROYCE
 580.....T-16/32
 582.....T-12/42

ROYCE (cont.)
 604.....T-3/56-57
 607.....T-12/42
 611.....T-14/55
 1-600.....T-19/64
 1-601.....C-1/26
 1-612.....C-5/45-46
 1-617.....T-3/52
 1-619.....T-3/56
 1-621.....T-3/57
 1-625.....T-3/56
 1-632.....C&S&T-11/21
C&S-13/23;S-5/14
 1-639.....C-15/48;T-12/41
 1-641.....C&S&T-11/20
S&T-4/51;T-3/60
 1-642..C&S&T-13/24;T-18/51
 1-650.....T-14/42
 1-651.....T-7/55
 1-655.....C-15/47;T-11/50
 1-660.....T-2/42
 1-673.....T-3/52
 1-675.....T-3/53
 1-680.....T-3/52

SANKYO
 SCS-555.....C&S-11/40

SBE
 LCB-8.....T-12/43
 LCBS-4.....C&S&T-7/29-33
 LCM-5.....T-9/36
 LCM-8.....T-9/36;12/42
 LCMS-4.....C&S&T-7/34-37
 LCMS-8.....T-12/43
 CONSOLE II..C-15/49;S-1/48
 CONSOLE IV...C&S-2/28-35
 CONSOLE V.....C-2/28-35
 CONSOLE V 40CB.....T-15/61
C&S&T-2/36-40
 CONSOLE VI.....C-8/14
 CORTEZ.....C&T-14/56-57
 CORTEZ 40.....T-3/61
 FORMULA D.....C-1/49
 FORMULA D 40.....T-3/61
 MALIBU 40.....T-3/53
 SIDEBANDER II.....C&S-1/47
 SIDEBANDER IV...S-2/28-35
 SIDEBANDER V 39CB.....
C&S-2/36-40
 SIDEBANDER VI.....C-8/14
 STOWAWAY.....T-3/53
 TAHOE 40.....T-3/53
 TOUCH/COM.....C-1/50-51
 TOUCH/COM 40.....T-9/36
 TRINIDAD III.....T-3/61

SEARS
 23 ch. SSB.....S-1/44
 CM-6000LA.....T-3/59
 CM-6000LC.....T-3/59
 D63911 (861C).....C-12/26
 ROADTALKER (SM5104).S-12/18
 370-38050700.....T-3/54
 562-38200700.....T-3/55
 562-38220700.....C-10/56
 663-38020800.....T-7/53
 663-38070700.....T-3/61
 663-3810.....C&S&T-11/22
 663-381050.....T-11/21
 934-36740500.....T-18/57
 934-3677150..C&S&T-12/16-17
 934-36772600.C&S&T-12/16-17
 934-38060700.....T-17/65
 934-38061700.....T-11/50
 934-38062700.....T-10/65
 934-38080700.....T-9/37

SEARS (cont.)
 934-38081700.....T-9/38
 934-38120700.....T-3/61
 934-38260700.....C-6/26-27
C-11/23;S-10/52;T-7/53
 934-38270700.....C-5/28-29
C-9/20-22;S-5/28;9/20
T-7/54
 934-38310700...S-5/19;9/22
T-7/54-55

SHAKESPEARE
 GBS240.....T-3/53

SHARP
 CB-23.....T-13/63
 CB-700.....T-20/41
 CB-750A.....C-19/52
 CB-800.....T-2/42
 CB-2170.....T-12/43
 CB-2460.....T-18/57
 CB-4370.....T-12/43
 CB-4470.....T-12/44
 CB-4670.....T-7/55
 CB-5470.....C&S&T-11/24

SILTRONIX
 SSB.....S-1/45
 1011C.....C-1/46
 1011D.....C-1/46

SOMMERKAMP
 TS-788DX.....C-13/25-30
 TS-340DX...A-20/39;SC-20/58

SONAR
 FS-2340.....C&T-5/31

SPARKOMATIC
 CB4020S.....C-14/41
 SR-42/CBM.....T-3/54

STANDARD HORIZON
 29.....T-1/22
 29A.....C-5/59;C&T-13/63

STONER
 PRO-40.....C&S-4/52-53

SUPERSCOPE AIRCOMMAND
 CB-340.....C-8/19;9/24
 CB-1040.....T-14/57

SUPERSTAR
 95.....C-19/45;SC-19/19
T-19/30
 120AM.....C-20/25;SC-20/62
T-20/29
 120 AM/FM.....C-20/27
 360.....SC-18/4
 2000.....C-18/28

SURVEYOR
 620.....T-3/55
 2610.....C-3/54

SWAN SIGNET
 270.....C-5/58

TEABERRY
 52 ch. Capability...C-1/43
 CAP MOD.....C-5/30
 BIG T.....T-15/61
 MODEL T.....C-4/3-4;T-3/55
M-19/68
 RACER T.....C-1/58;T-3/55
 RANGER T....C-4/1-2;6/24-25
 T BEAR.....C-4/14-15
 T CHARLIE.....T-10/65
 T COMMAND.....T-3/55
 T DISPATCH.C-4/14-15;T-3/55
 TITAN T...C-4/14-15;T-15/61

CODES: A - ALIGNMENT PROCEDURE; C - CONVERSION;

FC - FREQUENCY CHART; M - MISCELLANEOUS INFORMATION;

S - SLIDE; SC - SCHEMATIC; T - TUNE UP.

OOPS! WE GOOFED! AND CORRECTION INDEX!

	<u>VOL/PG</u>	<u>VOL/PG</u>	<u>ORIGINAL VOLUME</u>	<u>PAGE #</u>	<u>CORRECTION IN VOLUME</u>	<u>PAGE #</u>
TEABERRY (cont.)		WARDS	1	23	5	18
STALKER I.C1/57;4/5-6;10/11		GRN-680A.....T-14/61	1	61	16	72
STALKER II.....T-1/21		GEN-696A.....T-14/61	2	20,21	5	18
STALKER III.....T-7/55		GEN-719A.....C&S&T-11/10	3	4,7,11,25,33	5	18
STALKER IV.....T-12/44		GEN-775A.....T-3/61	3	25	11	78
STALKER V.....T-7/55		WKS	3	33	10	71
STALKER VIII.....T-10/65		100.....T&SC&M-19/64,66,67	4	5,45,50	5	17
STALKER IX.C-4/7-9;15/55-57		XTAL	4	38	12	66
.....S-4/7-8;T-10/65		XSSB10.....T-1/22	4	39	13	66
STALKER IX (EXPORT).....		YAESU	4	51	9	44
.....C-15/50-54;SC-19/20		101.....C-5/58	4	54	17	70
STALKER XII.....T-7/56		FT-7B.....C-7/38-41	4	10	21	23
STALKER XV.C&S-4/7-9;10/39		FT-102.....C-18/25	5	19,20,28	6	25
.....T-10/39		FT-707.....C-10/20-24	5	24,28,48	10	72
STALKER XX.....C&S&T-10/40		FT-757GX.....C-18/16	5	32	8	41
STALKER 101/202.....S-4/10		FT-757GX/SX.....C-19/52	5	47	18	62
TENNA		FT-901.....C-6/3-12	6	3,12	13	66
10901.....C-15/63;T-10/58		*****	6	31,32	7	62,63
10902.....T-10/65			6	32	11	78
11302 AM/FM/CB.....T-9/37			7	28	18	79
TRAM			7	31,37	8	42,43
D12.....C-10/56;T-3/54			7	46	19	42
D42.....C-4/47;5/40;19/52			7	49	10	25
D60.....C&S-1/52-53			7	43,53,63	11	66
D62.....S-10/45-46;15/15-17			8	16,17	10	72,73
.....C-19/52			8	17	9	29
D64.....C-11/12;S&T-13/31			8	52	11	78
D80.....C-10/30			9	9,29,51	10	72,74,75
D201.....C-1/56;3/22-23;4/48			9	12	18	79
.....C-17/53			9	13	19	79
D201A.....C-10/54;17/53			10	2	11	78
D300.....C-8/11-13;S-12/19			10	10,16,28	12	66
XL-5.....T-16/32			10	25,48	13	66,67
XLR (23-SSB).....C-17/53			10	49	18	79
TRISTAR			10	67	20	42
727.....SC-19/22;T-19/30			11	3,10,15,16,71	12	66
747.....C-15/58;16/68			11	4,6,11,41,75	13	67
.....S-17/35;A-19/48-51			11	10	19	68
TRS CHALLENGER			11	49	20	42
432.....T-4/23			12	7	15	69
460.....T-4/27-28;14/59			12	27,28	16	72
600.....T-4/27,29;9/37			12	CONV. 28	20	42
730.....T-4/27,30			13	63	15	69
850.....C&S&T-4/21-27,32-35			14	12	15	69
.....S-16/55;T-7/55			14	22,41	16	72
1200.....T-4/27,31;12/44			15	58	17	70
1400.....C&S&T-4/21-27,32-35			15	63,65	16	72
.....S-16/55			16	50,72	17	70
TRUETONE			18	23	19	54
CYJ4832-A-87.....T-2/43			18	26	19	68
CYJ4837-A-87.S-11/14;T-3/59			18	28	20	34
CYJ4862-A-87.....T-9/39			18	16	21	27
MCC4434-A-57.....T-14/60			19	20,35	20	76
MCC4726-A-67.....T-15/61			19	35-36	20	24
UNIMETRICS			19	34	21	34
DOLPHONE.....T-18/65			20	35,40,51	21	27,18,16
USACO			*****			
U900CB.....T-20/53						
UTAC						
TRX-400.....T-3/59						
TRX-500.....T-5/56						
VECTOR						
X.....T-2/43						
770.....C-4/56-57;T-9/37						
790.....C-4/58-59;T-9/37						

MISCELLANEOUS INDEX LISTED BY VOLUME

VOLUME 1

	PAGE #
CRYSTAL CROSS REFERENCE GUIDE.....	5-10
LETTER CHART FOR CRYSTAL FREQ. CORRELATION.....	11-18
GOLDEN EAGLE MARK IV PING MODIFICATION.....	20
GENERAL INFORMATION.....	63-67
LINEARS.....	68-70

VOLUME 2

	PAGE #
NEW CRYSTAL CROSS REFERENCE GUIDE.....	5-9
LETTER CHART FOR CRYSTAL FREQ. CORRELATION.....	10-13
PRESIDENT GRANT RF GAIN & ADJ. CH. REJ. MOD.....	18-19
ROBYN 510D/520D NOISE BLANKER ALIGNMENT.....	25-26
COBRA 139XLR SERVICE BULLETIN ON CRYSTAL DRIFT PROBLEM & PCB CRACKING.....	45-50
SERVICE BULLETIN ON SIDEBANDER II & CONSOLE II FOR IMPROVING CROSS MODULATION REJECTION.....	51
SERVICE BULLETIN - COBRA 29 ON MODULATION IMPROVEMENT, ALSO NOISE BLANKER.....	52
ANTENNA REPORTS.....	53-55
BETA-COM INFO (UPGRADING 23 CHANNEL RADIOS).....	57-87

VOLUME 3

	PAGE #
PRESIDENT MADISON FREQ. COUNTER MOD.....	16-18
NOISE WHINE CURE.....	24
MICROPHONE WIRING INSTRUCTIONS.....	26-32
PLL CHANNELIZER.....	33-40
ANTENNA SECRETS.....	63-64
SPECIAL SECTION ON LINEAR AMPLIFIERS:	
50-70W MOBILE.....	66
300-400W BASE.....	67-69
70W BASE.....	70-71
EAGLE 200.....	72
EAGLE 500.....	73
CONVERSION FROM AMATEUR TRANSMITTER TO LINEAR AMP	74
LINEAR AMP PROBLEMS & SOLUTIONS.....	75-76

VOLUME 4

	PAGE #
HOW TO BUILD YOUR OWN RELAY MODULE.....	16
O2A CHIP INFORMATION.....	54-55
HINTS & KINKS ON COBRA 62XLR & 142GTL.....	61
TURNER MIC EXPANDER (500AMC DISABLE).....	62
K40 BLINKIE.....	63
SUNSPOT PREDICTION CHART.....	64
LINEAR REPORT SECTION:	
D & A MAVERICK.....	65
D & A 500 TRIPLE CONVERSION.....	65
EAGLE 515 MODIFICATION.....	66-67
UNIDEN SSB 10 METER POWER CONVERSION.....	68-70
SUPER CLARIFIER DIODE.....	71

VOLUME 5

	PAGE #
10 METER CONV. WITH MICROMONITOR.....	1-5
ECHO BOX.....	6
250 WATT DUMMY LOAD-"SECRET CB'S LITTLE DUMMY"...	7
BUILT IN POWER MIKE.....	8-9
5-MILE SIMULATOR.....	10
RECEIVER PRE-AMP.....	11
GLEN DIGITAL CONTROLLER.....	12-13
GETTING SWR DOWN ON BASE ANTENNAS.....	15
APARTMENT ANTENNA.....	16
GROUNDING MOBILE RADIOS.....	17
DAK MARK IX POWER MODIFICATION.....	21-23
SUPER POWER MODULATION MOD FOR BOWMAN BASE CBH990	43
THE ART OF WIDEBANDING 858 CHIP.....	44
CONVERSION KIT + MARS & CAP FOR SSB.....	48-49
CONVERSION OF AM/SSB TO 10 METER AMATEUR.....	52
REDCO UFO INSTALLATIONS.....	61-69
HINTS & KINKS - COBRA 140/142/148GTL	
REGULATOR IC SHORTING OUT.....	70
SLIDE INCREASE, ALL SSB RADIOS.....	71

VOLUME 6

	PAGE #
PLL CRYSTAL CROSS REFERENCE GUIDE.....	1-2
SECRET CB TEST TONE.....	13
ERRONEOUS SIGNAL LOCATOR.....	14
LOW COST AMATEUR CONVERSION FOR 10 METERS.....	15
BASE ANTENNA GROUNDING.....	16-17
SUPER CLARIFIER 10-TURN POT.....	22
THUMBWHEEL 200 CHANNEL CONV. FOR 858 CHASSIS.....	31-34
REDCO UFO APPLICATIONS.....	40-52
SPECIAL SECTION ON LINEAR AMPLIFIERS:	
PDX 400.....	54
D & A MAVERICK 250.....	55
MACO DUSTER 300, 750 & 1000 TRANSMITTER.....	56-57
MACO 75.....	58
500 CX & 700 CX 10 to 11 METER CONVERSION.....	58
RDX-75.....	59
HDX-50.....	59
MDX-200.....	60
PDX-400.....	61
10 METER EXPERIMENTER BOARD INFORMATION.....	62-63
HOW TO MAKE CYBERNET CHASSIS SLIDE.....	65
HOW TO HOOK UP GLEN 310 to PRES. WASHINGTON.....	67
SUPER CLARIFIER HINTS.....	66
REDCO DX-50.....	68-70

VOLUME 7

	PAGE #
HOW TO MAKE YOUR EAGLE SCREAM.....	14
IMPROVED SLIDE MOD FOR O2A SSB RADIOS.....	42
UPDATED 200 CHANNEL AMATEUR CONV. FOR 858 CHIP...	43-48
10 METER CONVERSION FOR SSB RADIOS USING MB8719..	49-50
HOW TO MAKE YOUR 858 CHASSIS SLIDE.....	56
LINEAR AMPLIFIER NOTES.....	57
RECEIVE AMP - SILTRONIX.....	58-59
ECHO BOX SPEECH PROCESSING FOR TRC-449.....	60
ADDING PING.....	61
CORRECTION TO THUMBWHEEL 200 CHANNEL CONV.....	62-63
MICROMONITOR TECH NOTES.....	64-69
MICROMONITOR INSTALLATION FOR RADIOS USING 858...	70-71
AMP FOR RF PROBE.....	72
OSCILLOSCOPE MOD FOR RF & MODULATION DISPLAY....	73
THE BANDIT ANTENNA.....	74-76
SECRET CB'S OWN "TROUBLESHOOTER".....	77

VOLUME 8

	PAGE #
WHAT'S NEW ON THE ELECTRONICS HORIZON?.....	1-6
UHF FM CB (GMRS).....	7-10
UNIDEN MB8719 PLL CHIP FREQUENCY CONVERSION.....	15
FREQUENCY MOD FOR J.C. PENNEY, COLT, LAFAYETTE, HYGAIN, ETC.....	18
BROWNING MARK IVA MOD & UFO INSTALLATION.....	22-23
BROWNING MARK IV TRANSMITTER TROUBLESHOOTING....	25-32
LINEAR AMPLIFIER NOTES:	
INSTALLING A TROUBLESHOOTING LINEAR AMPS.....	47-49
10 METER AMP BOARD MOD TO UPRIGHT DRIVER.....	50
YOU CAN BUILD IT:	
TWO TONE GENERATOR.....	51
YAESU 601 (B) FREQ. COUNTER MOD. TO READ CB LOW, MIDDLE, HIGH FREQ.....	52-54
RF TEST METER.....	56-67
REDCO UFO MODIFICATION (from 20 to 29.995 MHz)...	55
SECRET CB'S POWER VECTORING.....	58
HOW THE ECHO BOX CAN ACTUALLY SURPASS THE POWER OF A LINEAR IN SSB.....	59
MICROMONITOR QUESTIONS.....	60-62
MICROMONITOR INSTALLATION INSTRUCTIONS:	
SM5104 PLL.....	63-64
ICOM 22S.....	65-67
NEW PRODUCT RELEASE:	
ZAPPER 9000 MOD. & REFERENCE CHART.....	68-69
REDCO DIGI-SCAN UFO ELITE.....	70
CHOPPER CHARLIE ANTENNA.....	71
TROUBLESHOOTER.....	73
AMATEUR VSB-1 (VOICE SIGNAL BOOSTER).....	82

VOLUME 9

SSB'ER LOSE OUT AGAIN..... 1
FCC ANNOUNCES PLANS FOR SIDEBAND..... 2-3
FCC DELAYS NPRM: SSB FREQS. DOUBTFUL..... 3-4
SPEED-O-MATIC "SPEEDO-1" X-BAND RADAR GUN..... 5-6
CONVERSION TIPS FOR ALL SSB RADIOS..... 7
RELAY CRYSTAL SWITCHING..... 25-26
LETTER FROM A FRIEND..... 27-28
HINTS & KINKS-ELECTRONIC CRYSTAL SWITCHING..... 29
SOLVING T.V.I..... 40-42
RADACRUZ..... 42
IMPORTANT FACTS ABOUT ECHO BOXES..... 43-44
VOICE SIGNAL BOOSTER (VSB-1) INSTALLATION..... 45-48
POWER SUPPLY MODIFICATION FOR REALISTIC
PRE-AMP NOISE-CANCELLING MIKE #21-1175..... 49-50
HINTS & KINKS - SWITCHABLE MODULATION INCREASE.... 51
RF ATTENUATOR..... 52-54
PRESIDENT SERVICE BULLETINS..... 55-61

VOLUME 10

SECRET CB TROUBLESHOOTER..... 2-4
VOICE SIGNAL BOOSTER - VSB-1..... 5-19
REPLACING MB8734 with MB8719..... 35
uPD2816C PLL PIN OUT..... 42
TECH TIPS ON 858..... 55
UNCONVERTIBLE CHIP LIST..... 66
LINEAR SUGGESTIONS..... 68-69
ZAPPER 9000 INSTALLATION HINTS..... 70
CB PARABOLIC TYPE ANTENNA..... 77

VOLUME 11

CPI ALC MODIFICATION FOR INCREASED SSB POWER..... 9
HOW TO ADD RF GAIN CONTROL TO A CPI 300/400..... 11
VSB-1 UPDATE ON NEW GRANT AND MADISON..... 25-26
NEW FRONTIER: FM CB..... 27-29
NEW PRODUCT: DIGI-SCAN DS-400..... 30-31
SERIAL DATA/PLL FREQUENCY SYNTHESIZERS..... 32
UNCONVERTIBLE AT THIS TIME : GE 3-5900A/TC9101P... 33
ADD CH 9 & 19AT TO COLT 210..... 33
ZAPPER 9000 INSTALLATION UPDATES..... 34
RADIO MODULATION ADJ. FOR VARIOUS MODELS..... 51-53
HINTS ON SERVICING..... 54
SERVICE NOTES-GOLDEN EAGLE MARK IV TRANSMITTER... 55
D104 & D104M6 ASTATIC MIKE MODIFICATION..... 55
HOW TO SOLVE NOISE PROBLEMS..... 56-57
MORE ON THE "TROUBLESHOOTER"..... 57
NOISE IN DIESEL TRUCKS..... 58
IN HOUSE VALUE LISTING..... 59
TRUCKERS SPECIAL POLARITY PROTECTOR WITH SMARTS... 60
HOW TO BUILD:
LOW PASS FILTER..... 61
20dB ATTENUATION PAD..... 61
BALUN COIL..... 62
1000Hz TONE..... 63
ADD A SECOND BATTERY..... 64
20 AMP POWER SUPPLY..... 65
SIGNAL INJECTOR..... 66
CMOS LOGIC PROBE..... 67
REFERENCE OSC-DIVIDER..... 68
READOUT MODIFICATION..... 69
ASTATIC MIC MOD..... 70
BILATERAL SWITCH..... 71
PLL PINOUT DIAGRAMS..... 72-77
THE "BANDIT ANTENNA"..... 53

VOLUME 12

SIMPLE CURE FOR RX-TX TRACKING PROBLEMS..... 21
HAM RADIO CRYSTAL SELECTOR GUIDE..... 24
VSB-1 HOOK-UP: STALKER XX,TRC490,WARDS 719A..... 25
MODULATION ADJUSTMENTS FOR VARIOUS REALISTICS.... 33
ZAPPER 9000 REFERENCE CHART..... 46
ZAPPER 9000 TROUBLESHOOTING HINTS..... 47-48
TC9106 PLL OPERATION ANALYSIS..... 50-53
SPREAD EAGLE ANTENNA FOR TRUCKERS..... 54-55
BASIC PLL..... 56
ELECTRONIC TERMINOLOGY..... 57
SCANNER PROGRAMING TIPS..... 58
INTO THE KNOW WITH JAPANESE SEMICONDUCTORS..... 59
TRANSISTOR SPECIFICATIONS..... 60
RESISTOR COLOR GUIDE..... 61-62
CAPACITOR CODES..... 62
YOU CAN BUILD:
"SECRET CB" SUPER DUPER POWER SUPPLY CONTROLLER 63
AUDIO TEST STATION..... 64
POWER LINE FILTER - T.V.I. FILTER..... 65

VOLUME 13

INTRODUCING THE SOMMERKAMP TS-788DX..... 4-9
MB8719 PINOUT..... 32
AGC SELECTOR SWITCH..... 38
BUILD VCO BLOCK - CYBERNET O2A CHASSIS..... 39
HOW TO HOOK UP A 10 TURN POT TO 2000 GTL..... 40
2824C OPERATION ANALYSIS..... 41-43
VSB-1 HOOK UP: TRC-488, MIDLAND 77-0004 4001.... 43-44
TROUBLESHOOTING CLARIFIER PROBLEMS ON THE 858... 45-47
SUPER REGULATOR..... 48
BUILD A RECEIVER PREAMP..... 49
LINEAR NOTES..... 50-51
MODULATION GUNN OSCILLATOR..... 52-56
CYBERNET O2A AM POWER INCREASE..... 59
REALISTIC DX300 (20-204)..... 64
BEARCAT 250..... 65

VOLUME 14

MB8719/11.3258 TRUTH TABLE..... 15-17
FM-30B THRU-LINE FREQ. COUNTER..... 18-19
"KIT A" FOR LC7130/7131 & TC9106P CHIPS
AND INSTALLATION INSTRUCTIONS..... 20-40
BROWNING PING INFORMATION..... 41
25-29 MHZ FREQUENCY ASSIGNMENTS..... 62-63
ELECTRONIC TERMINOLOGY..... 63
YOU CAN BUILD:
FET RECEIVER PRE-AMP..... 64
BUILD YOUR OWN SPACE SOUND..... 65
BUILD AN AMPLIFIER (150 WATT)..... 66-67

VOLUME 15

NEW MICROSCAN PLUS SYSTEM..... 5-6
BREAKING THAT CHIP..... 7-11
O2A TRUTH TABLE..... 12-13
MEASURE FREQUENCY ON SCOPE..... 17
PM77 POWER MODULATOR KIT..... 19
DIGITAL PROCESSOR KIT/uPD2824..... 28
WIRE GAUGE CONVERSION CHART..... 41
O2A 23 CHANNEL AM MOD..... 59
POWER MOD. FOR AM UNITS..... 65
PRE-CONVERSION TIPS..... 70
CONVERT A SALVAGED METER TO VOLT. METER..... 71
STATE/INTERNATIONAL DISIGNATORS..... 72

VOLUME 16

	PAGE #
VS8-1 UPDATE FOR COBRA 2000.....	6
SAMS CB MANUAL - OUT OF PRINT.....	7
CALL SIGNAL/FREQUENCY CHARTS.....	9-20
HINTS/KINKS/GOOFS.....	31
M58472P PLL CHIP MOD.....	33
OSCILLATOR CHECKER, LOW CAPACITY PROBE.....	34
TROUBLESHOOTER GUIDE.....	35-36
INTO THE KNOW WITH POTS.....	37
"MY WAY" SLIDE.....	38
BLEED-OVER FILTER.....	40
LOOP FILTER - WHAT IS IT?.....	42
COLOR CODE GUIDE FOR CHOKES.....	42
ANTENNA INFORMATION.....	56
O2A CLARIFIER/BANDSWITCH MOD.....	57-59
HIGH CURRENT METER.....	63-64
SWR VS REFLECTED POWER CHART.....	65
CUSTOM FREQUENCY STANDARD.....	66-67
CHECKING MODULATION.....	69
DIGITAL PROCESSOR KIT (#146) UPDATE.....	70-71

VOLUME 17

	PAGE #
"B" KIT FOR LC7130/7131 & TC9106P CHIPS AND INSTALLATION INSTRUCTIONS.....	4-33
SECRET CB KIT #106 FOR TRC-451.....	36-38
M58472 PLL CHIP (UPDATE).....	39
FORGOTTEN ACCIDENT (23CH XTAL CONV. INFO).....	39
HINTS/KINKS/GOOFS.....	46
U-BUILD IT: BURGLAR ALARM.....	48
U-BUILD IT: CUSTOM REGULATED POWER SUPPLY.....	49-50
GYPSY FREQUENCY CHART/KIT INFO.....	51-52
PLL CHIP INFO.....	59
REALISTIC PRO-54 SCANNER (D.C. MOD.).....	62-64
VIDEO "DUBBING/COPYING" TIPS.....	64-65
VCR VIDEO MOD. TRS-80 VIDEO DISPLAY.....	66-69

VOLUME 18

	PAGE #
EXPORT ROUNDUP INFO.....	5-12
MB CHASSIS SERVICE NOTE.....	13
CAUTION-CIRCUITS-QUICKIE.....	14
SM5104 PLL FREQUENCY MOD. (AM CHASSIS).....	20-21
10KHz FLIP-FLOP.....	23
REALISTIC PRO-22 (SPECIAL NOTES).....	33
PARTS INFO: LAFAYETTE, COLT, SBE, PALOMAR.....	34
TROUBLE SHOOTING TABLES - SSB UNITS: REC86345, O2A (2-BOARD), 858, 8734/8719, 2824/2816.....	35-39
LINEAR TIPS FOR SQUEAL ON TX.....	41
HINTS/KINKS/GOOFS.....	42
ROBYN OWNERS-PARTS SOURCE & TECH NOTES.....	43
HELP WANTED.....	43
861 PLL AM CHASSIS (UPDATE).....	45
CONVERSION CHARTS.....	46
MB8719 WITH 11.1125 CRYSTAL INFO.....	47
RADIO SHACK MIKE WIRING.....	48-49
\$MONEY MAKERS\$.....	50
ANTENNA TUNING.....	51
KIT 137 INSTALLATION INSTRUCTIONS & SPEC.....	52-53
LARK FREQUENCY CHART.....	54
SAMS CB/SCANNER MANUAL '84 UPDATE.....	55
\$\$INDIVIDUAL I.R.A. - TUBES\$\$.....	57
SURVEY RESULTS.....	58-59
SAVE THE CHIP-MAYBE THE METER.....	60
REMOTE CONTROL OF AMPLIFIER.....	61
THINK SMALL! CRYSTAL INFO.....	62
VIDEO (UPDATE).....	63-65
ANTENNA MOUNTING-MOBILE.....	66
VOLTAGE REGULATOR DESIGN.....	69
ALL ABOUT CRYSTALS.....	70

VOLUME 19

	PAGE #
EARS.....	5-7
EXPORT ROUNDUP.....	10-17
EDITORS NOTES.....	18
CAUTION-DOUBLE BOARD EXPORTS.....	31
DOUBLING-UP FOR CURRENT.....	31
CROSS-REFERENCE ON SAMS CB MANUALS.....	32-33
SERVICE TIPS - EXPORT - CYBERNET O2A PLL.....	37
GEORGE FREQUENCY CHART.....	38-39
ALPHA FREQUENCY CODE CHART.....	43
POLARITY PROTECTOR AND OVER-VOLTAGE PROTECTION... ..	44
DUOFONE ET-350 (R/S 43-366).....	45
HOW TO ORDER CRYSTALS.....	47
"SECRET CB" SUPER CLARIFIER DIODE & SUPER SLIDE.. ..	53
BONUS - HAVING TROUBLE BROADBANDING ON UNITS?....	54
ROYCE OWNERS PARTS INFO.....	54
CORRECTION FOR 10K FLIP-FLOP, V18/P23.....	54
HINTS/KINKS/GOOFS.....	55
FREQUENCY CHART FOR 10KHz FLIP FLOP MOD IN V18... ..	56
MODULATION SWITCH - 858 SSB CHASSIS.....	59
WARNING - ANTENNA'S.....	59
TROUBLE SHOOTING TIP - 858 SSB CHASSIS.....	60
BLEED OVER FILTER (UPDATE).....	61
SALVAGE OF POWER SUPPLIES.....	62
VIDEO TAPE.....	63
858 SSB CHASSIS - ADJACENT CHANNEL REJECTION.....	67

VOLUME 20

	PAGE #
TRAM PARTS SOURCE.....	4
R/S 1175 "EXPORT" WIRING HOOK-UPS.....	6-7
WINNER & ANSWER TO "SUPER DIODE PUZZLE CONTEST".. ..	16
RATING THE EXPORTS.....	17
"EDITED" EXPORT ROUNDUP.....	18-19
EXPORTS.....	20-21
TESTING THOSE "BULK PAK/QUESTIONABLE/ UNMARKED" ZENERS.....	26-27
NEEDED INFO.....	28
MODIFICATION OF EXPORT O2A 5-CRYSTAL CHASSIS.....	37
O2A 'EXPORT' CHASSIS "MULTIPLEX & DIRECT" BAND SWITCHING.....	38
SAMS CROSS REFERENCE: HELP.....	54
HINTS/KINKS/GOOFS.....	55
EXPORT LIST.....	63-64
SATELLITE PROGRAM INFORMATION.....	65-68

C O N T R I B U T O R - F O R M

PLEASE COPY AND USE THIS FORM

P R I N T

Contributor: _____

DATE: _____

CHECK ONE

Address: _____

Yes Print Name in Secret CB

Don't Print Name in Secret CB

Phone Number/Time convenient to call if necessary: _____

All above will be CONFIDENTIAL, Selman Ent. doesn't give out mailing list!

Unit Name/Model/FCC ID #: _____

PLL: _____ MODES OF TRANSMISSION: _____

Number of Channels: _____ Frequency Range: _____

Owners Manual available: _____ Sent In: (Will be returned) _____

ORIGINAL Schematic available: _____ Sent In: (Will be returned) _____

Information/contribution Vol. _____ Secret CB.