

This Information Is Provided By
CBTricks.com
Service Manual

Liability of damages to any equipment is the sole responsibility of the user! Downloading, viewing, or using any information provided on these pages automatically accepts the user to the terms of this agreement!

Modifications are provided for information purposes only!

Supporters of CBTricks.com paid for the hosting so you would have this file.

CBTricks.com is a non-commercial personal website was created to help promote the exchange of service, modification, technically oriented information, and historical information aimed at the Citizens Band, GMRS (CB "A" Band), MURS, Amateur Radios and RF Amps.

CBTricks.com is not sponsored by or connected to any Retailer, Radio, Antenna Manufacturer or Amp Manufacturer, or affiliated with any site links shown in the links database. The use of product or company names on my web site is not endorsement of that product or company.

The site is supported with donations from users, friends and selling of the Site Supporters DVD's to cover some of the costs of having this website on the Internet instead of relying on banner ads, pop-up ads, commercial links, etc. Thus I do not accept advertising banners or pop-up/pop-under advertising or other marketing/sales links or gimmicks on my website.

ALL the money from donations is used for CBTricks.com I didn't do all the work to make money (I have a day job). This work was not done for someone else to make money also, for example the ebay CD sellers.

All Trademarks, Logos, and Brand Names are the property of their respective owners.

This information is not provided by, or affiliated in any way with any radio or antenna Manufacturers.

Thank you for any support you can give.

For information on how to Support CBTricks.com

<http://www.cbtricks.com/support/>

LA-30 HF Linear Amplifier

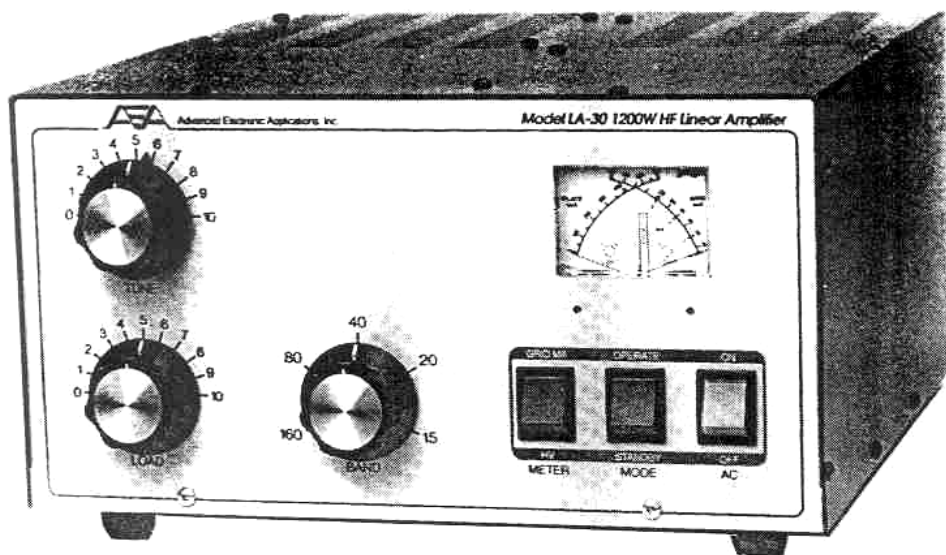

Operating Manual



Part Number 040-049-10
July 1990
Copyright 1990

FORWARD

Congratulations on your purchase of the AEA LA-30 HF Linear Amplifier. It should provide you with years of excellent performance in a compact and lightweight package.

To fully enjoy the benefits of the LA-30, please read this manual carefully before operating the amplifier. If you have questions, we encourage you to contact an AEA authorized dealer or one of our technical support representatives at:

Advanced Electronic Applications, Inc.
P.O. Box C2160 / 2006-196th St. SW
Lynnwood, WA 98036-0918
Tel: (206) 775-7373
FAX: (206) 775-2340
Telex: 6972496 AEA INTL UW

TABLE OF CONTENTS

1.0 SPECIFICATIONS		
1.1	RF Specifications	3
1.2	General Information	3
2.0 INTRODUCTION		
2.1	Features	4
3.0 INSTALLATION		
3.1	Unpacking	5
3.2	Operating Location	6
3.3	Power Tube Installation	6
3.4	Cabling	7
	AC Power	7
	Antenna Coax	7
	Input Cable	7
	ALC Cable	7
	Antenna Relay	7
4.0 OPERATING CONTROLS		
4.1	Front Panel Controls and Indicators	8
4.2	Rear Panel	10
5.0 WARNINGS		
	High Voltage	10
	RF Power	10
6.0 OPERATION		
6.1	Preliminary Settings	10
6.2	Operation	11
	SSB/CW/RTTY	11
	Actual Settings	12
	AM Operation	13
	ALC Adjustment	13
7.0 SERVICE		
7.1	How & When to Contact AEA's Technical Support	13
7.2	Return to Factory Procedure	14
7.3	Warranty Service	14
7.4	Non-Warranty Service	14
8.0 SCHEMATIC DIAGRAM		15
9.0 WARRANTY		16

1.0 SPECIFICATIONS

1.1 RF SPECIFICATIONS

FREQUENCY RANGE

160 meters	1.8 to 2.0 MHz
80 meters	3.5 to 4.0 MHz
40 meters	7.0 to 7.3 MHz
30 meters	10.1 to 10.15 MHz
20 meters	14.0 to 14.35 MHz
17 meters	18.068 to 18.168 MHz
15 meters	21.0 to 21.45 MHz
*12 meters	24.85 to 24.95 MHz
*10 meters	28.0 to 29.7 MHz

* FCC rules permit any properly licensed amateur to modify his/her own amplifier for 10 meter use. Contact the factory for details. If this modification is done with reasonable skill and care, it will not affect the warranty.

DRIVE POWER	40 W nominal to 60 W maximum, 50 W for full output
RF INPUT POWER	SSB 1.2 KW PEP; CW/RTTY/AM/SSTV/FM 1.0 KW
PLATE VOLTAGE (Operating Pos.)	3000 VDC (idle)
EFFICIENCY	60% (50% on 10 meters)
INPUT IMPEDANCE	50-ohm tuned impedance matching circuit.
OUTPUT IMPEDANCE	50 ohms
HARMONIC SUPPRESSION	-40 dB minimum
INTERMOD. DISTORTION	-33 dB minimum

1.2 GENERAL INFORMATION

POWER TUBE	3-500Z zero-bias triode
CIRCUIT TYPE	Class AB2 grounded grid
TUBE COOLING	Pressurized plenum cooling system; 30 ft ³ /min. low noise squirrel-cage blower
TYPE OF EMISSION	SSB, CW, RTTY, AM, SSTV, FM
DUTY CYCLE	Continuous duty in SSB; 50% duty in other modes
ALC CIRCUIT	Negative, adjustable
ANTENNA RELAY	DC relay for hum-free operation
METERING SYSTEM	Dual meter measures plate current, plate voltage and grid current (patent-pending measuring system)
OUTPUT CIRCUIT	Pi-L network (silver-plated air coil)
INPUT CIRCUIT	Pi network input for maximum drive and linearity
PROTECTIVE DEVICES	AC line fuse, cathode zener fuse, line interlock, HV interlock, filament inrush surge limiter
POWER TRANSFORMER	Special transformer, rated @ 600 VA 60 Hz
DIMENSIONS	14" W x 7-1/2" H x 16-1/2" D (overall) (36 x 19 x 42 cm)
WEIGHT	35 lb. (15.9 kg.)

2.0 INTRODUCTION

The LA-30 Linear Amplifier is a one stage, class AB₂ linear amplifier using a glass envelope, high performance 3-500Z power triode tube. It is a completely self-contained table-top unit capable of 1200 watts PEP input, designed to provide reliable, stable, high RF output power. It is equipped with a pressurized plenum cooling system to ensure optimum operation for extended periods of continuous use. The circuit and components are conservatively designed and selected for efficient operation under all conditions.

2.1 FEATURES

- Designed for SSB, CW, RTTY, AM, FM or SSTV operation on the amateur bands between 1.8 MHz and 21 MHz* (including WARC bands and MARS operation). May be customer modified to cover the 28 MHz band. Please contact the factory.
*Canadian and other non-U.S.A. models supplied with 10 meter band.
- Can be modified for frequencies outside the amateur bands for commercial or military use. Please contact the factory.
- Fast-heating, high-performance 3-500Z triode ensures rapid warm-up time.
- Continuous duty plenum cooling squirrel-cage blower.
- Pi-L output circuit featuring:
 - a) Heavy-duty rotary switch with silver plated contacts.
 - b) High-quality loading and plate-tuning capacitors.
- Pi network input circuit
- The power supply features a special heavy-duty "continuous" rated 600 VA transient-protected power transformer and computer-grade filter capacitors for maximum reliability.
- OPERATE/STANDBY switch on front panel.
- Adjustable ALC delay control.
- Cross-needle meter system to monitor all critical voltages and currents.
- Vernier tuning for smooth and accurate settings on all bands.
- Grid overload protection circuitry.

3.0 INSTALLATION

CAUTION: There are lethal voltages present inside the amplifier when the power is on. NEVER remove the top cover unless the HV reading is 0 V.

PLEASE READ THE INSTRUCTIONS carefully and fully before attempting to operate the amplifier.

3.1 UNPACKING

Remove the amplifier from the shipping carton and examine for damage. Notify the transport company immediately if any damage is present). Save the carton for future shipment to another location or for storage. The 3-500Z triode tube is shipped separately and must be installed before operating the amplifier in any way.

The following are included with your LA-30 amplifier (see fig. 3.1):

1. Instruction manual
2. Warranty card
3. 3-500Z tube
4. Glass chimney
5. ALC and relay control cables
6. Extra fuses (one Zener - AGC 1/2 and one MDA-15)

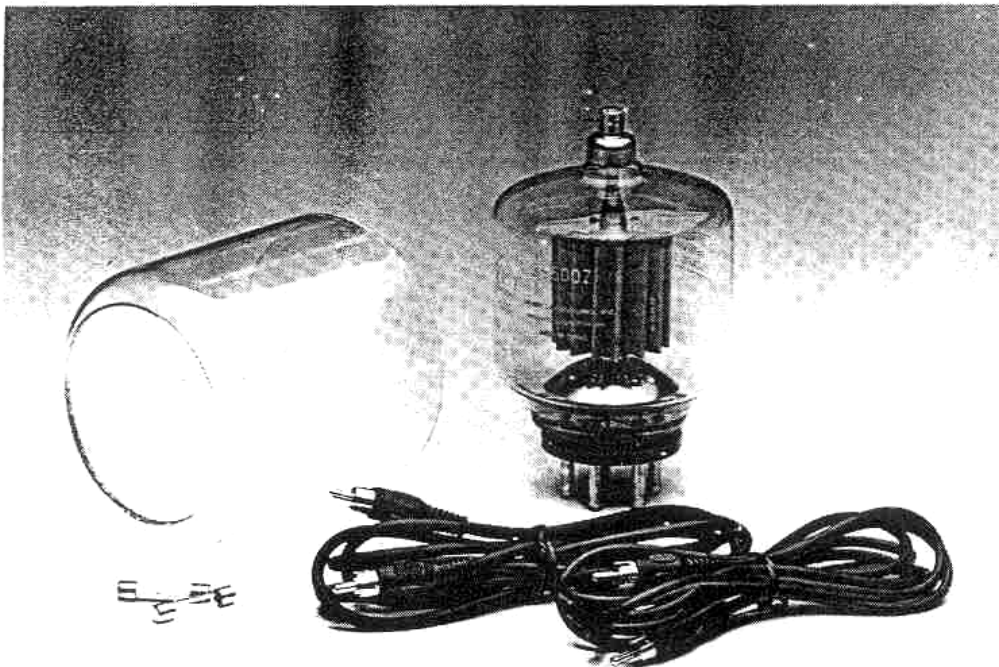

Fig. 3.1

3.2 OPERATING LOCATION

The amplifier must be located in an open area such that the flow of air from the top is unrestricted. Location should be as close as possible to a reliable 115 VAC source to minimize any AC voltage drop.

3.3 POWER TUBE INSTALLATION

For the power tube installation, you will need the following:

- One 3-500Z tube (packed separately)
- One glass chimney

1. Unpack all items and inspect for damage. Any damage should be reported to the carrier.
2. Remove all cabinet screws except the four around the screen on the top of the cabinet and remove top cover. A total of 19 screws will be removed.
3. Carefully install the power tube in its socket. Be very careful not to exert lateral or twisting pressure on the glass portion of the tube, as it is very easily damaged. Excessive pressure can cause a hairline fracture in the tube's glass envelope, destroying the tube. The pins are also particularly delicate and can easily break if the tube is not inserted and removed very carefully.
4. Carefully set the glass chimney in place over the power tube, making sure all holding clips are inside the chimney and the chimney rests on the chassis..
5. Set the plate cap heat sink in place on the anode connector of the power tube. See Fig. 3.3

NOTE: Be sure to hold the heat sink firmly when tightening the set screw.

6. Gently tighten the set screw.
7. Re-assemble the cabinet. Do not tighten any screws until they are all installed. This completes the power tube installation.

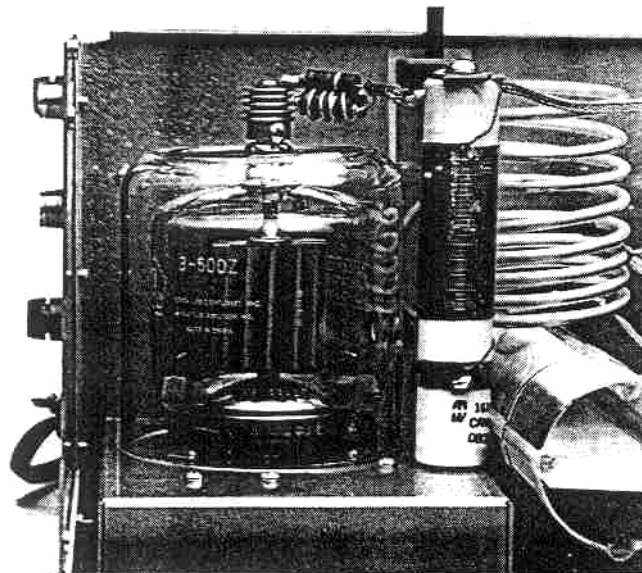

Fig. 3.3

3.4 CABLING

The following cables must be connected before the amplifier is operated (with the exception of the optional ALC cable):

AC POWER

The cable attached to the AC CORD input on the rear panel of the amplifier must be connected to a reliable 115 VAC source. Under worst-case conditions, the LA-30 will draw about 12 A, so it will probably need an isolated wall circuit and breaker to itself.

ANTENNA COAX

Use only RG 8/U (or equiv.) to connect the LA-30 to the antenna. The antenna connector mates with the connector marked RF OUT on the rear panel of the amplifier.

CAUTION: Do not operate the amplifier without a load or into a load with SWR greater than 2:1. Measure the antenna's SWR with an SWR meter or in-line wattmeter and determine that the SWR is in fact less than 2:1.

With the **STANDBY/OPERATE** switch in the **STANDBY** position (IN), the exciter output will bypass the amplifier and feed directly to the antenna.

INPUT CABLE

A cable must be connected from the output of your exciter to the **RF IN** connector on the rear panel of the amplifier.

ALC (Automatic Level Control) CABLE

Plug the ALC cable into the phono jack located on the back panel (marked ALC) and into the ALC feedback connection (or equiv.) on the exciter. If the exciter does not have provision for feedback of ALC voltage from the amplifier, then simply omit the use of the cable.

ANTENNA RELAY

A control cable should be plugged into the phono socket marked **PTT** on the rear panel of the amplifier. This cable connects the keying signal from the exciter to switch the amplifier to the transmit condition and must be plugged into the socket or connector marked Antenna Relay (or equiv.) on the exciter. The exciter need only supply a shorting relay contact (during transmit) to key the amplifier (24 V @ 50 mA max.). **CAUTION:** Do not apply any voltage to the PTT phono jack.

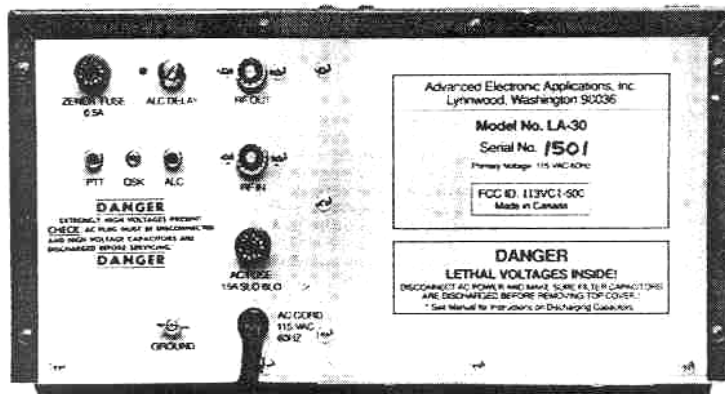

4.0 OPERATING CONTROLS

4.1 FRONT PANEL CONTROLS AND INDICATORS

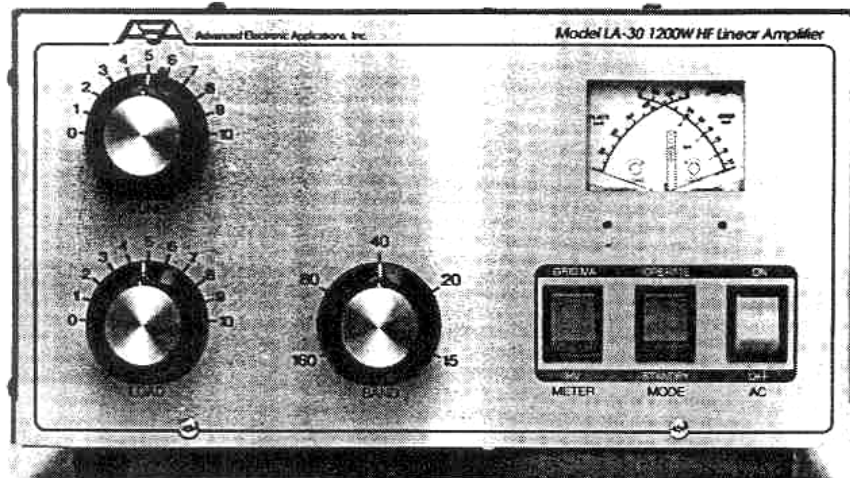

ON/OFF SWITCH

Controls AC power to the amplifier.

METER SWITCH

Selects the multi-meter functions as below:

HV: The meter monitors the amplifier's plate voltage. The full scale reading in this mode is 4000 VDC. Normal plate voltage with the amplifier in the idle mode (no drive power) is about 3100 VDC. Line voltage variations will cause corresponding variations in the plate voltage (Note: Reading for plate voltage is x 1 kV).

GRID: The meter monitors the amplifier's grid current. The full-scale meter reading in this mode is 200 mA DC. The nominal grid current in SSB on peaks is approximately 50 mA. Maximum grid current in SSB or CW single-tone is 120 mA (marked on the meter as a red bar).

MODE SWITCH

In the STANDBY position, the power of the exciter bypasses the LA-30 and appears unchanged at the output connector. In the OPERATE position, the LA-30 is ready for transmitting.

OPERATE LIGHT

The pilot light in the meter indicates the status of the amplifier. When the MODE switch is in the OPERATE position, the meter light is ON. When in the STANDBY position, the meter light is OFF.

4.2 REAR PANEL

(see also section 3.4, Cabling)

ZENER FUSE	Protects the cathode circuit from over-current. It is a 1/2 amp fast-blow fuse.
ALC ADJUST	Controls the delay of the LA-30's ALC circuit.
AC MAIN	One fuse for the 115 VAC line input. This is an MDA 15 A ceramic fuse and must not be replaced with any other type.
GROUND	Grounds the amplifier. Should be connected to a good earth ground to minimize radiated interference or the danger of electrical shock.

5.0 WARNINGS

THERE ARE LETHAL VOLTAGES present inside the amplifier whenever the HV reading is greater than 0 V. This can be true if the unit is on or off. NEVER remove the top cover of the unit unless the HV reading is 0 V. Doing so greatly increases your risk of electric shock and also may damage the amplifier.

Presently, there is not significant data on the hazards of long-term exposure to signals transmitted in the 1.8 to 30 MHz range. Some scientists do have concern and are studying the problem. In any case, as the LA-30 has the capability to generate very large RF circulating currents and RF voltages, you should keep your hands and eyes away from the rear panel of the amplifier when it is transmitting to avoid possibly serious RF burns.

6.0 OPERATION

NOTE: Use a 50 ohm dummy load rated at 1500 watts or greater (such as the AEA DL-1500) only for all following adjustments.
--

6.1 PRELIMINARY SETTINGS:

<u>SWITCH</u>	<u>SET TO</u>
ON/OFF	OFF
MODE	STANDBY
METER	HV

Activate the ON switch. Look into the interior of the amplifier to make sure the tube filament is lit. Put your hand over the top of the cabinet and check for a flow of air from the amplifier.

6.2 OPERATION

The 3-500Z triode requires no warm-up time.

1. Set the BAND switch to the desired band.
2. Pre-set the TUNE and LOAD vernier dials to that referred to in calibration chart, Table 4.1.
3. The meter should read approximately 3, indicating a plate voltage of 3000 VDC.
4. Push the METER switch to GRID MA.
5. Push the MODE switch to the OPERATE position.

SSB / CW / RTTY OPERATION USING THE "TUNING BAR" SYSTEM

1. With the exciter adjusted for zero output, press the PTT switch of the exciter, causing the LA-30 and the exciter to go into the transmit mode.
2. The amplifier's plate current meter should read approximately 60 mA (no drive applied).
3. Increase the RF output of the exciter until the amplifier's grid current is about 50-60 mA – adjust the TUNE control for a minimum plate current reading indicating resonance (plate current will be around 200-250 mA).

As you increase the input power to the amplifier from the exciter, the cross needle meter will read both plate and grid current simultaneously. The needles will cross either to the left or right of the tuning bar. See figures 5.2.3 and 5.2.4.

If the needles cross to the left of the TUNED bar, an underload condition exists. Rotate the LOAD control clockwise so that the needles will cross inside the TUNED bar. See Fig. 5.2.1.

If the needles cross to the right of the TUNED bar, an overload condition exists. Rotate the LOAD control counter-clockwise so that the needles will cross inside the TUNED bar. See Fig 5.2.2.

NOTE: Any rotation of the LOAD control should be followed by readjustment of the TUNE control for resonance.

4. To verify the peak power condition, increase the RF output of the exciter for a plate current reading of 400 mA. With the full drive, the grid current should be 120 mA. The needles should cross inside the TUNED bar at this point. If not, rotate the LOAD control to compensate per the procedure on page 11, and re-dip the TUNE control for resonance. Make sure you have enough drive to get 400 mA of plate current and 120 mA of grid current. Single tone adjustments while tuning should be made such that the grid current NEVER exceeds 120 mA, as this very quickly reduces the life of the tube (Use of a dummy load for these measurements is preferred.).
5. Release the PTT switch of the exciter to unkey the amplifier and exciter. Put the exciter into the SSB mode, and, while speaking into the microphone, adjust the audio gain control for voice peak-plate-current readings of around 200 mA. Since the meter is average reading and cannot follow the peaks (which are about 400 mA), the meter will indicate the highest average plate current. The grid current peaks should be around 40 mA. Check for proper drive with a monitor scope if one is available.
6. The LA-30 is equipped with a grid trip protection circuit. This circuit is factory adjusted to 60 mA of grid current. If the amplifier is overdriven and the trip circuit is activated, the meter light will extinguish. To reset the grid trip circuit, simply push the MODE switch to STANDBY and back to OPERATE. The meter light will come back on, and the amplifier will be ready to operate again.

NOTE: It is normal for the 3-500Z tube to show color, glowing a pale red with 200 mA of plate current and a brighter cherry red at 400 mA. When operated in this manner, the tube is within its ratings and can be operated this way only if the plate circuit is at resonance (plate current dipped to a minimum with TUNE control). The amplifier should never be operated for any length of time in an off-resonance condition.

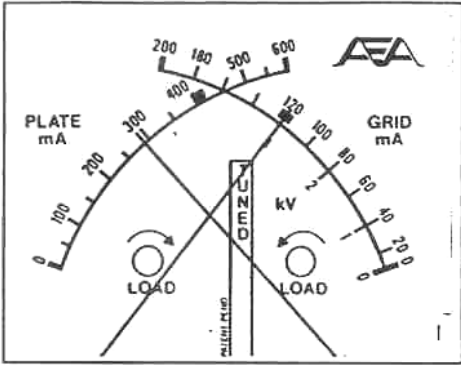

Figure 5.2.1 UNDERLOADED

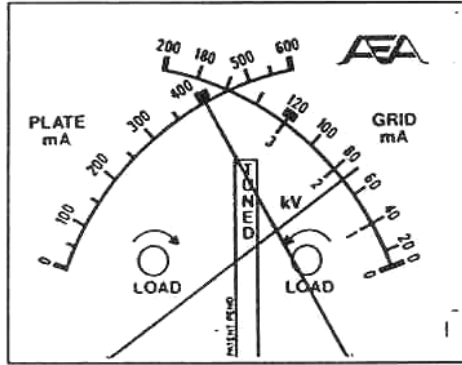

Figure 5.2.2 OVERLOADED

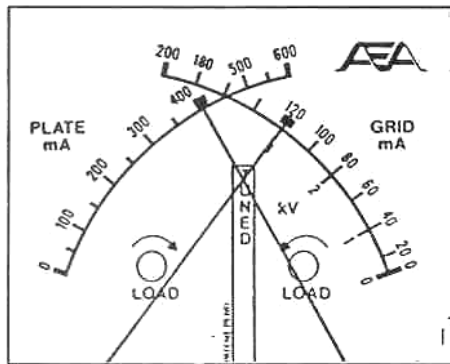

Figure 5.2.3 OPTIMUM LOADING

Table 5.2 Actual Settings

FREQ (MHz)	TUNE	LOAD
1.8	_____	_____
1.9	_____	_____
2.0	_____	_____
3.5	_____	_____
4.0	_____	_____
7.0	_____	_____
7.3	_____	_____
14.0	_____	_____
14.3	_____	_____
18.1	_____	_____
21.0	_____	_____
21.4	_____	_____
24.9	_____	_____
28.0	_____	_____
29.0	_____	_____
29.7	_____	_____

AM OPERATION

Do not apply modulation. Tune the amplifier as per 5.2.1, step 4 with plate current at 320 mA max. and grid current at approximately 60 mA. Reduce the carrier output so that plate current is 1/2 of previous reading. Grid current will be approximately 30 mA. Apply 1000 Hz tone at 100% modulation. Plate current should not exceed previous maximum value. If it does, reduce the mic. gain as necessary. If an oscilloscope or modulation monitor is available, check that the modulation does not exceed 100%.

ALC ADJUSTMENT

The ALC control should be in the fully clockwise position. Drive the amplifier to the desired output level and then rotate the ALC control counter-clockwise until the grid current just begins to decrease.

7.0 SERVICE

7.1 HOW AND WHEN TO CONTACT AEA'S TECH SUPPORT

If your LA-30 appears not to be working properly, you should first try to isolate the problem. Try temporarily replacing pieces of equipment in the shack (i.e. transceiver, power supply, antenna, etc.) with a friend's equipment which is known to be functional.

Please attempt to solve problems locally, using other hams or an AEA dealer. Many of the AEA products that are sent to us for repair are in perfectly good order when we receive them.

Once you have determined the problem to be in the LA-30, check your sales receipt to see if the unit was purchased by you within the 90-day warranty period. If so, contact your dealer to find out what his policies are regarding warranty service.

If your unit is out of warranty, troubleshooting assistance may be had by calling AEA from 8:00-12:00 am and 1:00-4:30 pm Pacific time. The phone number is (206) 775-7373. Ask for the Technical Support Department. Please have your product's serial number available, as well as information about any other equipment connected to the LA-30. Also, please have the unit hooked up and powered on when you call if possible. The technician will likely ask you several questions regarding the unit.

PLEASE DO NOT RETURN THE LA-30 TO US WITHOUT CONTACTING US FOR PERMISSION FIRST. WE WOULD LIKE THE OPPORTUNITY TO TROUBLESHOOT THE PROBLEM OVER THE PHONE FIRST, SAVING YOU BOTH TIME AND MONEY.

7.2 RETURN TO FACTORY PROCEDURE

If the unit must be sent in, we will give you a Return Merchandise Authorization (RMA) number over the telephone. This number should be clearly written on the outside of the package, as we use it to keep track of your unit while it is in the AEA plant.

Units sent in must be shipped to our street address:

AEA, Inc.
2006 196th St. S.W.
Lynnwood, WA 98036

Be sure to include your street address for the return shipping.

UPS Surface (Brown Label) takes up to eight days, depending on your location. UPS Second-Day Air (Blue Label) takes 2-3 days. UPS Overnight (Red Label) will get your unit here in one day but is very expensive. The LA-30 should be sent in a way that it can be traced if we cannot verify receipt of shipment. We suggest UPS or insured postal shipment.

7.3 WARRANTY SERVICE

If the LA-30 is still under the original owner's warranty, AEA will repair the unit for no charge and pay the cost of the return shipment. The current policy is that it will be returned UPS Brown Label if received Brown or by U.S. Mail; returned Blue Label if received Blue or Red or by other overnight service; or returned as the owner states in his/her letter if he/she furnishes the return cost for the method he/she selects. A copy of the sales receipt must be included with each unit sent in for warranty service.

The warranty is for the original owner only and is not transferrable.

7.4 NON-WARRANTY SERVICE

If the LA-30 is out of warranty, the \$50 flat repair rate (subject to change without notice or obligation) may be either charged to your Visa or MasterCard, paid for by personal check or money order or returned UPS COD. The \$50 flat rate includes return shipping per the above policy.

For either Warranty or Non-Warranty service, we will typically have a unit repaired and ready for return shipping within 5 to 10 working days, if we have all the facts. If we need to call you for some reason, it may take longer. PLEASE include a letter stating the problem in detail and any additional information which may help us find the problem. Also include any phone numbers where you can be reached if necessary. AEA is not responsible for damage caused by acts of God, improper alterations, poor storage/handling, etc.

8.0 SCHEMATIC DIAGRAM

- NOTES:
1. ALL CAPACITORS IN MFD. UNLESS OTHERWISE MARKED.
 2. S1 SHOWN 1.8MHZ POSITION.
 3. ONLY 1.8MHZ & 2.4/2.8 MHZ NETWORKS SHOWN FOR CLARITY.

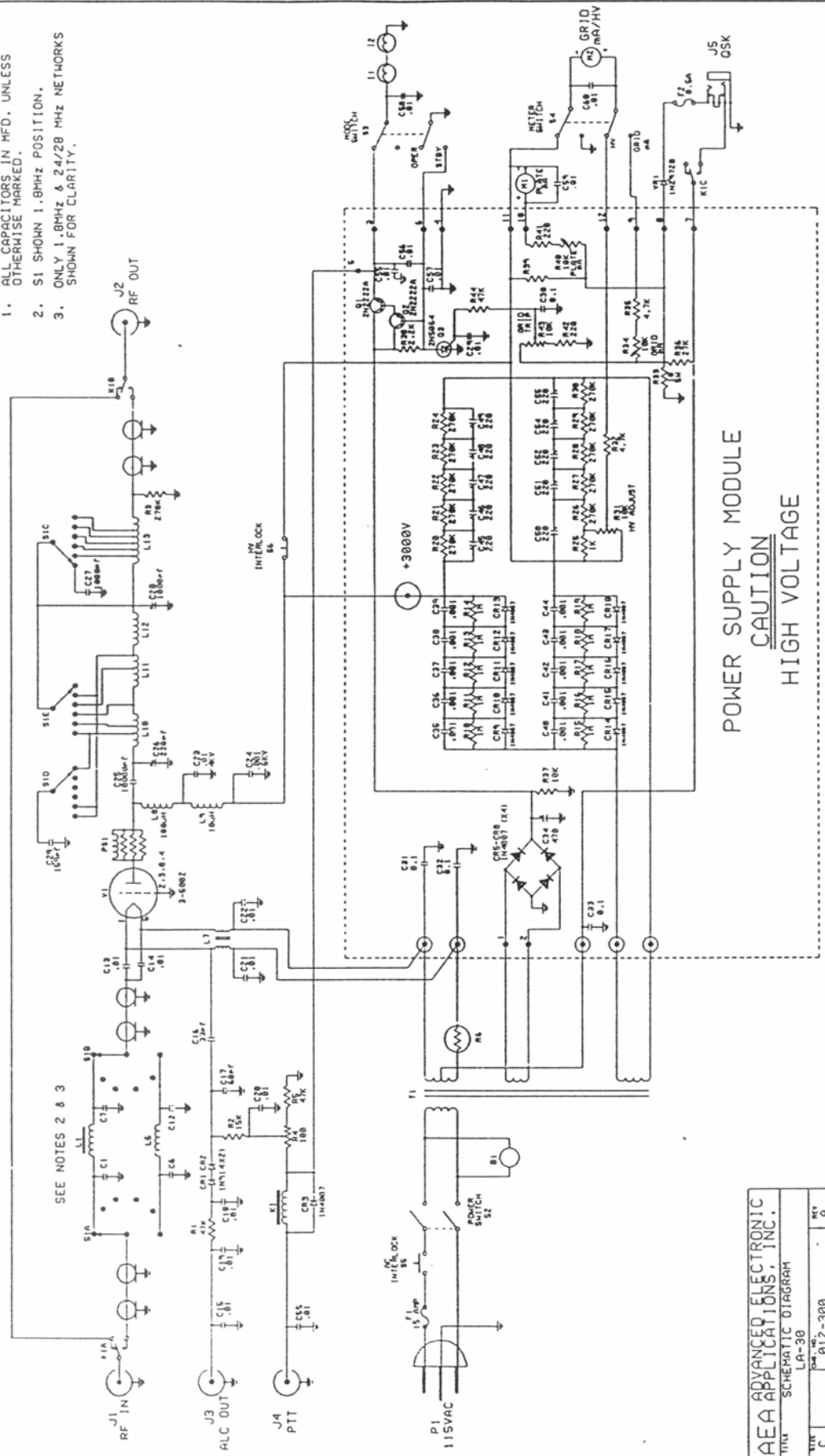

POWER SUPPLY MODULE
CAUTION
 HIGH VOLTAGE

AEA ADVANCED ELECTRONIC APPLICATIONS, INC.			
SCHEMATIC DIAGRAM			
REV	DATE	BY	CHK
C	012-300	R	
DATE	7-28-50	SHEET	1 OF 1

9.0 WARRANTY

LIMITED WARRANTY

ADVANCED ELECTRONIC APPLICATIONS, INC. warrants to the original purchaser that this product shall be free from defects in material or workmanship for ninety days from the date of original purchase. In order to obtain warranty service: (1) Complete and mail the warranty registration card within 10 days to Advanced Electronic Applications, Inc., and (2) Send written notification to the address below or telephone as soon as possible after discovering a possible defect:

Advanced Electronic Applications, Inc.
Attention: Technical Support
2006 - 196th St. S.W.
Lynnwood, WA 98036
(206) 775-7373

The written notification must include a copy of the invoice. Include a description of the defect part or condition, with details of the electrical connections to associated equipment and list such equipment. Please enclose your name, phone number, and address. Shipping charges for any parts or units submitted for replacement under this warranty must be paid by the purchaser.

Correct maintenance, repair and use are important to insure proper performance from this product. Carefully read the Operating Manual. This warranty does not apply to any defect AEA determines is caused by (1) improper maintenance or repair, including the installation of parts or accessories that do not conform to the quality and specification of the original parts; (2) misuse, abuse, neglect, or improper installation; (3) accidental or intentional damage; (4) acts of God. The field installation of circuits or batteries according to the instructions in the manual will not nullify this warranty.

All implied warranties, if any, terminate ninety days from the date of original purchase. AEA is not responsible for damage to other equipment or property or any other consequential or incidental damage of any kind whether based on contract, negligence, or strict liability. Maximum liability shall not, in any case, exceed the purchase price of the unit.

The foregoing constitutes AEA's entire obligation with respect to this product. The original purchaser and any user or owner shall have no other remedy and no claim for incidental or consequential damages. Some states do not allow limitations of how long an implied warranty lasts or do not allow the exclusion of incidental or consequential damages, therefore, the above limitations and exclusions may not apply to you.

This warranty gives specific legal rights. You may also have other rights which vary from state to state.